

THIS DOCUMENT IS THE PROPERTY OF  
KEYSTONE ELECTRONICS CORP. AND  
SHALL NOT BE REPRODUCED, DISTRIBUTED  
OR USED AS A BASIS FOR MANUFACTURE  
WITHOUT PRIOR WRITTEN PERMISSION  
FROM KEYSTONE ELECTRONICS CORP.

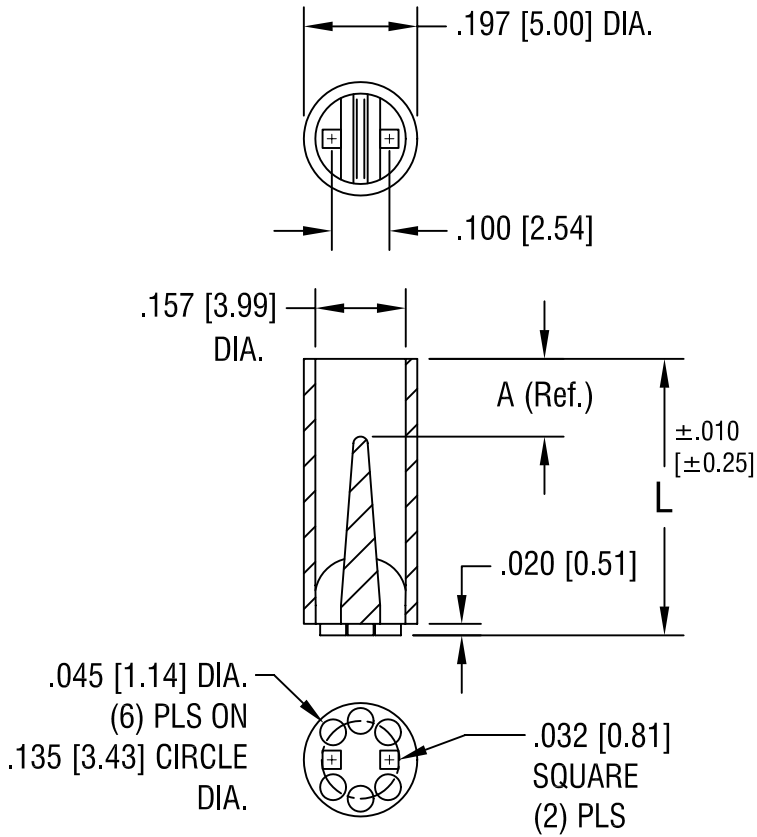

PART NO.	'L' DIM.	'A' DIM. REF.
8327	.400 [10.16]	.075 [1.91]
8328	.420 [10.67]	.095 [2.41]
8329	.440 [11.18]	.115 [2.92]
8330	.450 [11.43]	.120 [3.05]
8331	.460 [11.68]	.135 [3.43]
8332	.480 [12.19]	.145 [3.68]
8333	.500 [12.70]	.055 [1.40]
8334	.550 [13.97]	.095 [2.41]
8335	.600 [15.24]	.150 [3.81]
8336	.650 [16.51]	.075 [1.91]
8337	.700 [17.78]	.120 [3.05]
8338	.750 [19.05]	.055 [1.40]
8339	.800 [20.32]	.110 [2.79]
8340	.850 [21.59]	.160 [4.06]
8341	.900 [22.86]	.200 [5.08]
8342	.925 [23.50]	.230 [5.84]

**KEYSTONE ELECTRONICS CORP.**

ASTORIA, N.Y. 11105-2017

PART NAME		BI-LEAD LED SPACER, T-1 3/4	
MATERIAL		NYLON 6/6	
FINISH	-	DRN BY	BOONE
		APP'D	LN
		DATE	11.14.96
		SCALE	3X
TOLERANCES	INCH [MM]	CODE	DWG NO.
DECIMAL	± .005 [± 0.15]	C/M	8327-8342
ANGULAR	± 1°		
UNLESS OTHERWISE SPECIFIED			

5.4.99	CHANGE AS PER ECN 99-044	B
3.18.99	CHANGE AS PER ECN 99-027	A
DATE	DESCRIPTION	REV.

# Mouser Electronics

Authorized Distributor

Click to View Pricing, Inventory, Delivery & Lifecycle Information:

[Keystone Electronics:](#)

[8341](#)