

THIS DOCUMENT IS THE PROPERTY OF
KEYSTONE ELECTRONICS CORP. AND
SHALL NOT BE REPRODUCED, DISTRIBUTED
OR USED AS A BASIS FOR MANUFACTURE
WITHOUT PRIOR WRITTEN PERMISSION
FROM KEYSTONE ELECTRONICS CORP.

ACTUAL SIZE

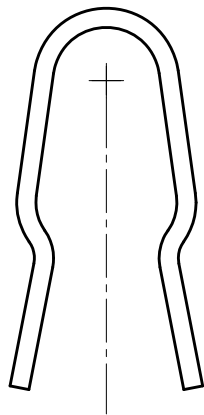

SHOWN AS
SUPPLIED

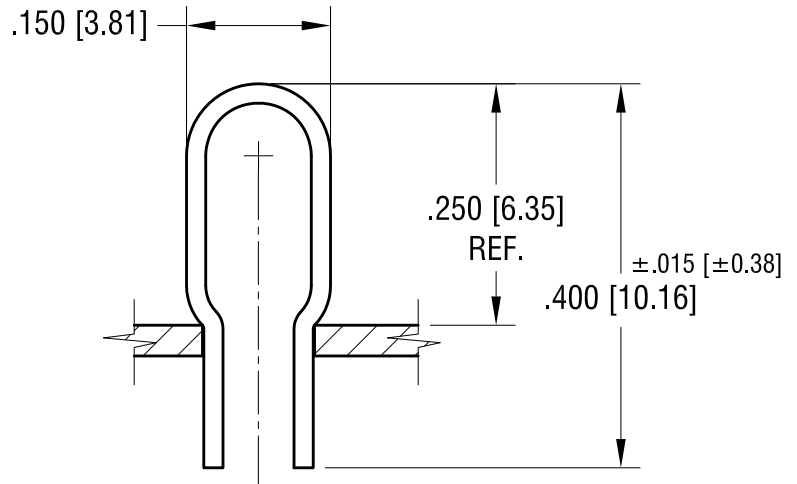

SHOWN AS
INSTALLED INTO
.112 [2.84] TO .116 [2.94] DIA.
MOUNTING HOLE

3.05.14	CHANGE AS PER ECN 14-020	C
1.02.14	CHANGE AS PER ECN 14-006	B
5.14.13	CHANGE AS PER ECN 13-040	A
DATE	DESCRIPTION	REV.

KEYSTONE ELECTRONICS CORP.			
www.keyelco.com • ASTORIA, N.Y. 11105-2017 • Tel (718) 956-8900			
PART NAME			
THRU-HOLE MOUNT TEST POINT			
MATERIAL			
.020 [0.50] DIA. PHOSPHOR BRONZE , 510 ALLOY			
FINISH		DRN BY	DATE
SILVER PLATE		NT	3.07.13
		APP'D	SCALE
		LN	5X
TOLERANCES	INCH [MM]	CODE	DWG NO.
DECIMAL	± .005 [± 0.13]	C	5024
ANGULAR	± 1°		
UNLESS OTHERWISE SPECIFIED			

Mouser Electronics

Authorized Distributor

Click to View Pricing, Inventory, Delivery & Lifecycle Information:

[Keystone Electronics:](#)

[5024](#)