

THIS DOCUMENT IS THE PROPERTY OF
KEYSTONE ELECTRONICS CORP. AND
SHALL NOT BE REPRODUCED, DISTRIBUTED
OR USED AS A BASIS FOR MANUFACTURE
WITHOUT PRIOR WRITTEN PERMISSION
FROM KEYSTONE ELECTRONICS CORP.

MTG. DETAIL

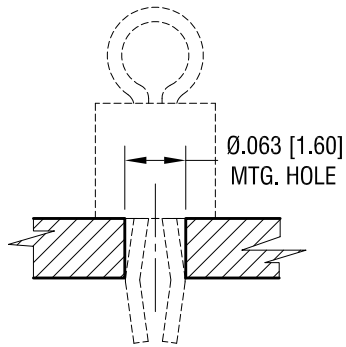

ACTUAL SIZE

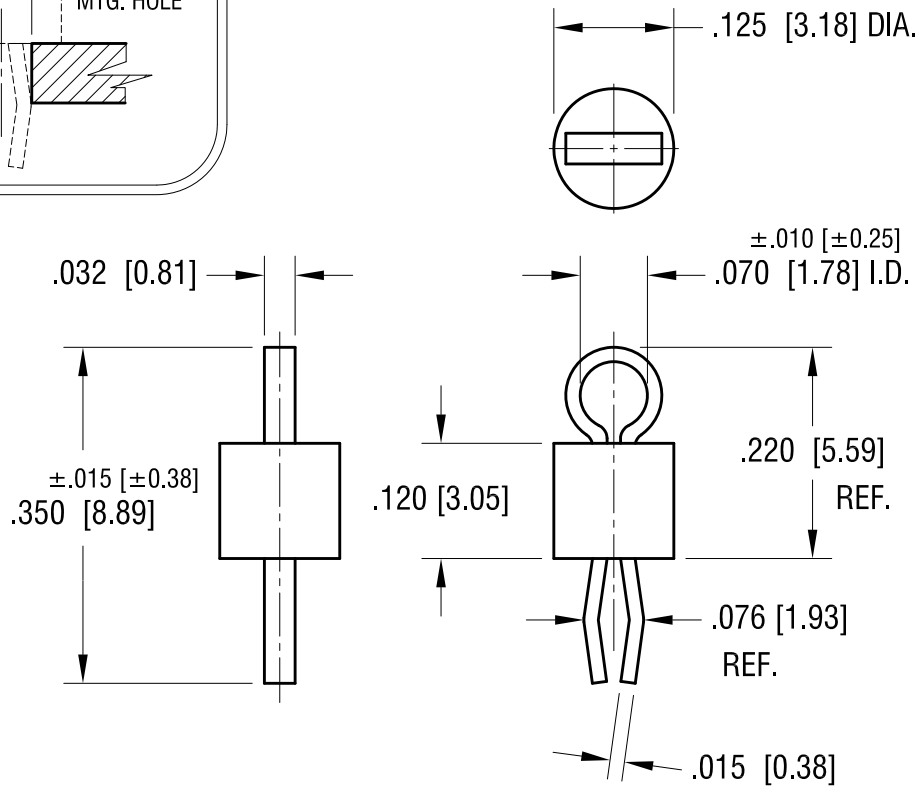

NOTES:

- 1. TERMINAL:
MAT'L - PHOSPHOR BRONZE WIRE
- 2. BASE:
MAT'S - HEAT RESISTANT NYLON 46

PART NO.	BASE COLOR
5005	RED
5006	BLACK
5007	WHITE
5008	ORANGE
5009	YELLOW

DATE	DESCRIPTION	REV.
12.30.13	CHANGE AS PER ECN 13-120	F
12.04.08	CHANGE AS PER ECN 08-190	E

KEYSTONE ELECTRONICS CORP.			
www.keyelco.com • ASTORIA, N.Y. 11105-2017 • Tel (718) 956-8900			
PART NAME			
PC TEST POINT - COMPACT			
MATERIAL			
AS NOTED			
FINISH		DRN BY	DATE
SILVER PLATE		NT	12.09.08
		APP'D	SCALE
		LN	5X
TOLERANCES	INCH [MM]	CODE	DWG NO.
DECIMAL	± .005 [± 0.15]	C	5005-5009
ANGULAR	± 1°		
UNLESS OTHERWISE SPECIFIED			

Mouser Electronics

Authorized Distributor

Click to View Pricing, Inventory, Delivery & Lifecycle Information:

[Keystone Electronics:](#)

[5006](#)