

# IRLS4030PbF IRLSL4030PbF

HEXFET® Power MOSFET

### Applications

- DC Motor Drive
- High Efficiency Synchronous Rectification in SMPS
- Uninterruptible Power Supply
- High Speed Power Switching
- Hard Switched and High Frequency Circuits

### Benefits

- Optimized for Logic Level Drive
- Very Low  $R_{DS(ON)}$  at 4.5V  $V_{GS}$
- Superior  $R^*Q$  at 4.5V  $V_{GS}$
- Improved Gate, Avalanche and Dynamic  $dV/dt$  Ruggedness
- Fully Characterized Capacitance and Avalanche SOA
- Enhanced body diode  $dV/dt$  and  $dI/dt$  Capability
- Lead-Free

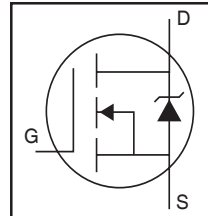

$V_{DSS}$		<b>100V</b>
$R_{DS(on)}$	typ.	<b>3.4mΩ</b>
	max.	<b>4.3mΩ</b>
$I_D$		<b>180A</b>

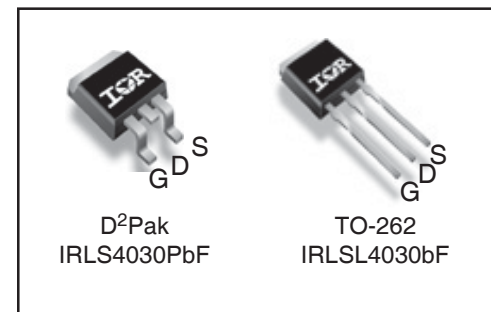

<b>G</b>	<b>D</b>	<b>S</b>
Gate	Drain	Source

### Absolute Maximum Ratings

Symbol	Parameter	Max.	Units
$I_D @ T_C = 25^\circ\text{C}$	Continuous Drain Current, $V_{GS} @ 10\text{V}$	180	A
$I_D @ T_C = 100^\circ\text{C}$	Continuous Drain Current, $V_{GS} @ 10\text{V}$	130	
$I_{DM}$	Pulsed Drain Current ①	730	
$P_D @ T_C = 25^\circ\text{C}$	Maximum Power Dissipation	370	W
	Linear Derating Factor	2.5	W/°C
$V_{GS}$	Gate-to-Source Voltage	± 16	V
$dv/dt$	Peak Diode Recovery ③	21	V/ns
$T_J$	Operating Junction and	-55 to + 175	°C
$T_{STG}$	Storage Temperature Range		
	Soldering Temperature, for 10 seconds (1.6mm from case)	300	

### Avalanche Characteristics

$E_{AS}$ (Thermally limited)	Single Pulse Avalanche Energy ②	305	mJ
$I_{AR}$	Avalanche Current ①	See Fig. 14, 15, 22a, 22b	A
$E_{AR}$	Repetitive Avalanche Energy ④		mJ

### Thermal Resistance

Symbol	Parameter	Typ.	Max.	Units
$R_{\theta JC}$	Junction-to-Case ⑧⑨	—	0.40	°C/W
$R_{\theta JA}$	Junction-to-Ambient (PCB Mount) ⑦⑧	—	40	

Static @  $T_J = 25^\circ\text{C}$  (unless otherwise specified)

Symbol	Parameter	Min.	Typ.	Max.	Units	Conditions
$V_{(BR)DSS}$	Drain-to-Source Breakdown Voltage	100	—	—	V	$V_{GS} = 0V, I_D = 250\mu A$
$\Delta V_{(BR)DSS}/\Delta T_J$	Breakdown Voltage Temp. Coefficient	—	0.10	—	V/ $^\circ\text{C}$	Reference to $25^\circ\text{C}$ , $I_D = 5mA$ ①
$R_{DS(on)}$	Static Drain-to-Source On-Resistance	—	3.4	4.3	m $\Omega$	$V_{GS} = 10V, I_D = 110A$ ④
		—	3.6	4.5		$V_{GS} = 4.5V, I_D = 92A$ ④
$V_{GS(th)}$	Gate Threshold Voltage	1.0	—	2.5	V	$V_{DS} = V_{GS}, I_D = 250\mu A$
$I_{DSS}$	Drain-to-Source Leakage Current	—	—	20	$\mu A$	$V_{DS} = 100V, V_{GS} = 0V$
		—	—	250		$V_{DS} = 100V, V_{GS} = 0V, T_J = 125^\circ\text{C}$
$I_{GSS}$	Gate-to-Source Forward Leakage	—	—	100	nA	$V_{GS} = 16V$
	Gate-to-Source Reverse Leakage	—	—	-100		$V_{GS} = -16V$
$R_{G(int)}$	Internal Gate Resistance	—	2.1	—	$\Omega$	

Dynamic @  $T_J = 25^\circ\text{C}$  (unless otherwise specified)

Symbol	Parameter	Min.	Typ.	Max.	Units	Conditions
gfs	Forward Transconductance	320	—	—	S	$V_{DS} = 25V, I_D = 110A$
$Q_g$	Total Gate Charge	—	87	130	nC	$I_D = 110A$
$Q_{gs}$	Gate-to-Source Charge	—	27	—		$V_{DS} = 50V$
$Q_{gd}$	Gate-to-Drain ("Miller") Charge	—	45	—		$V_{GS} = 4.5V$ ④
$Q_{sync}$	Total Gate Charge Sync. ( $Q_g - Q_{gd}$ )	—	42	—		$I_D = 110A, V_{DS} = 0V, V_{GS} = 4.5V$
$t_{d(on)}$	Turn-On Delay Time	—	74	—	ns	$V_{DD} = 65V$
$t_r$	Rise Time	—	330	—		$I_D = 110A$
$t_{d(off)}$	Turn-Off Delay Time	—	110	—		$R_G = 2.7\Omega$
$t_f$	Fall Time	—	170	—		$V_{GS} = 4.5V$ ④
$C_{iss}$	Input Capacitance	—	11360	—	pF	$V_{GS} = 0V$
$C_{oss}$	Output Capacitance	—	670	—		$V_{DS} = 50V$
$C_{rss}$	Reverse Transfer Capacitance	—	290	—		$f = 1.0MHz$
$C_{oss \text{ eff. (ER)}}$	Effective Output Capacitance (Energy Related)⑥	—	760	—		$V_{GS} = 0V, V_{DS} = 0V \text{ to } 80V$ ⑥
$C_{oss \text{ eff. (TR)}}$	Effective Output Capacitance (Time Related)⑤	—	1140	—		$V_{GS} = 0V, V_{DS} = 0V \text{ to } 80V$ ⑤

## Diode Characteristics

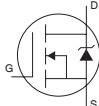
Symbol	Parameter	Min.	Typ.	Max.	Units	Conditions
$I_S$	Continuous Source Current (Body Diode)	—	—	180	A	MOSFET symbol showing the integral reverse p-n junction diode. 
$I_{SM}$	Pulsed Source Current (Body Diode) ①	—	—	730		
$V_{SD}$	Diode Forward Voltage	—	—	1.3	V	$T_J = 25^\circ\text{C}, I_S = 110A, V_{GS} = 0V$ ④
$t_{rr}$	Reverse Recovery Time	—	50	—	ns	$T_J = 25^\circ\text{C}$ $V_R = 85V,$
		—	60	—		$T_J = 125^\circ\text{C}$ $I_F = 110A$
$Q_{rr}$	Reverse Recovery Charge	—	88	—	nC	$T_J = 25^\circ\text{C}$ $di/dt = 100A/\mu s$ ④
		—	130	—		$T_J = 125^\circ\text{C}$
$I_{RRM}$	Reverse Recovery Current	—	3.3	—	A	$T_J = 25^\circ\text{C}$
$t_{on}$	Forward Turn-On Time	Intrinsic turn-on time is negligible (turn-on is dominated by LS+LD)				

## Notes:

- ① Repetitive rating; pulse width limited by max. junction temperature.
- ② Limited by  $T_{Jmax}$ , starting  $T_J = 25^\circ\text{C}$ ,  $L = 0.05mH$   
 $R_G = 25\Omega, I_{AS} = 110A, V_{GS} = 10V$ . Part not recommended for use above this value.
- ③  $I_{SD} \leq 110A, di/dt \leq 1330A/\mu s, V_{DD} \leq V_{(BR)DSS}, T_J \leq 175^\circ\text{C}$ .
- ④ Pulse width  $\leq 400\mu s$ ; duty cycle  $\leq 2\%$ .

- ⑤  $C_{oss \text{ eff. (TR)}}$  is a fixed capacitance that gives the same charging time as  $C_{oss}$  while  $V_{DS}$  is rising from 0 to 80%  $V_{DSS}$ .
- ⑥  $C_{oss \text{ eff. (ER)}}$  is a fixed capacitance that gives the same energy as  $C_{oss}$  while  $V_{DS}$  is rising from 0 to 80%  $V_{DSS}$ .
- ⑦ When mounted on 1" square PCB (FR-4 or G-10 Material). For recommended footprint and soldering techniques refer to application note # AN-994.
- ⑧  $R_\theta$  is measured at  $T_J$  approximately  $90^\circ\text{C}$ .
- ⑨  $R_{\theta JC}$  value shown is at time zero.

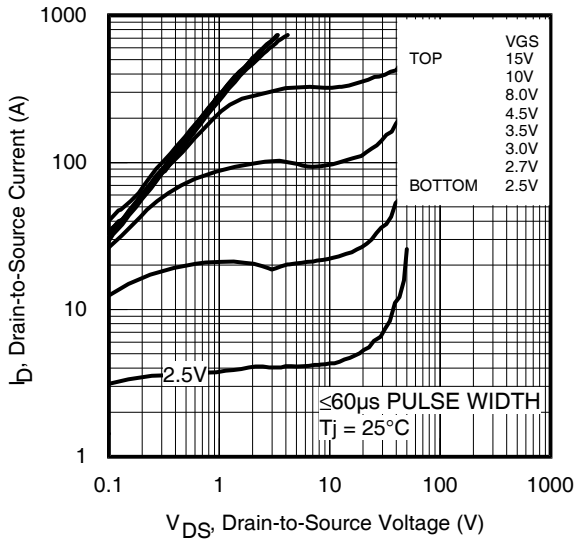

Fig 1. Typical Output Characteristics

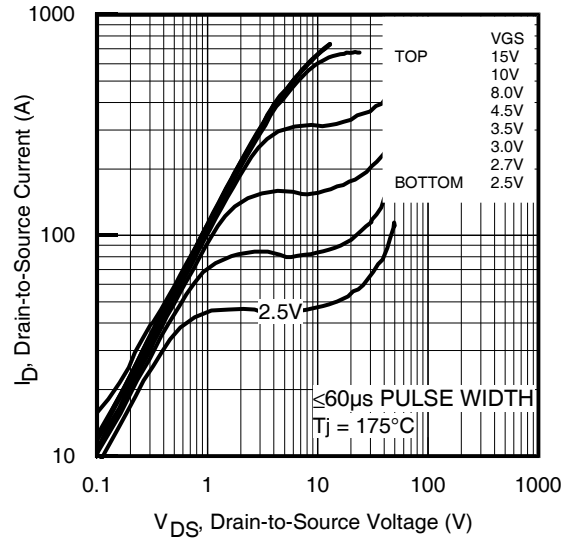

Fig 2. Typical Output Characteristics

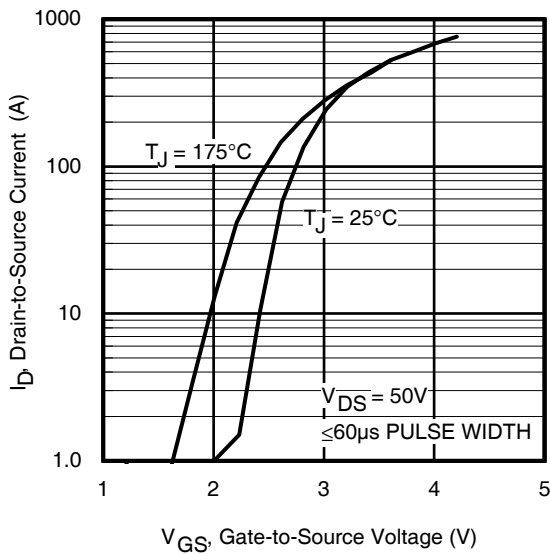

Fig 3. Typical Transfer Characteristics

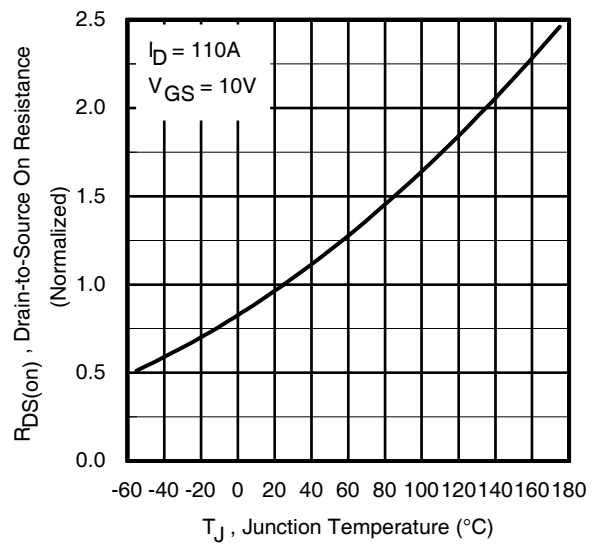

Fig 4. Normalized On-Resistance vs. Temperature

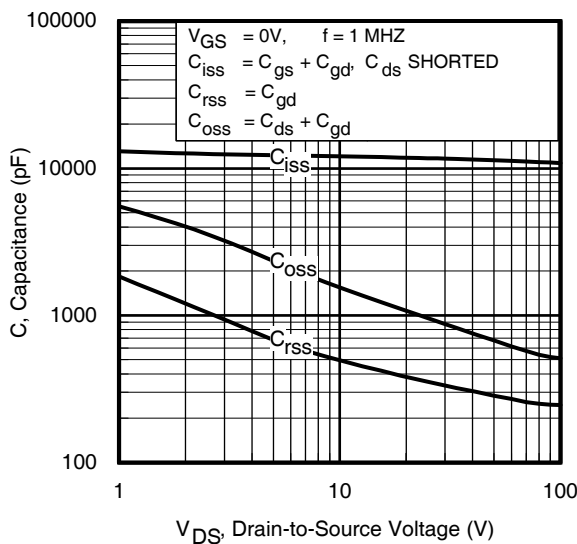

Fig 5. Typical Capacitance vs. Drain-to-Source Voltage

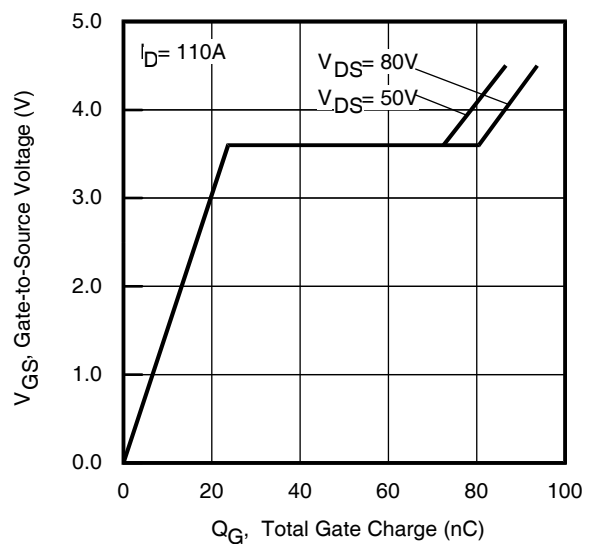
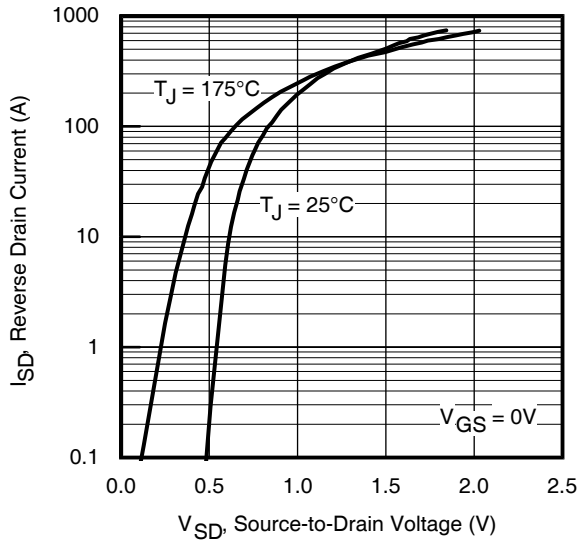
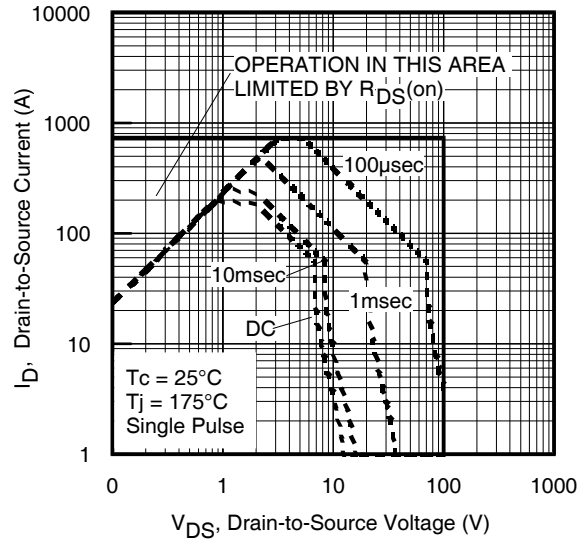

Fig 6. Typical Gate Charge vs. Gate-to-Source Voltage



**Fig 7.** Typical Source-Drain Diode Forward Voltage



**Fig 8.** Maximum Safe Operating Area

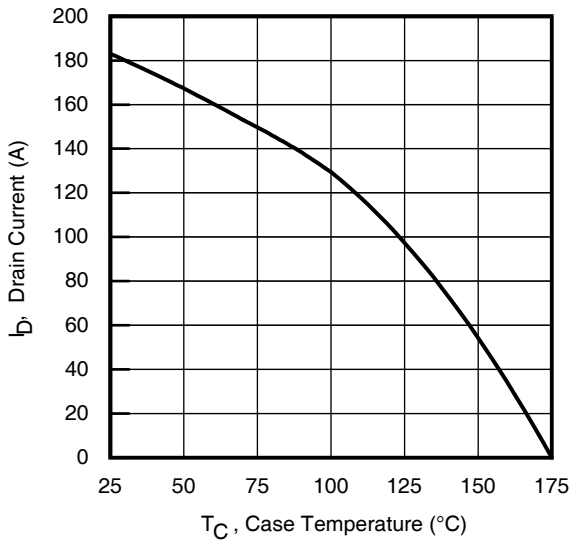

**Fig 9.** Maximum Drain Current vs. Case Temperature

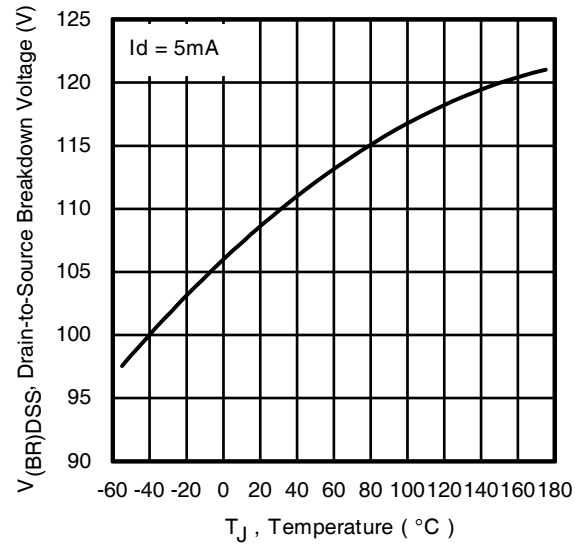

**Fig 10.** Drain-to-Source Breakdown Voltage

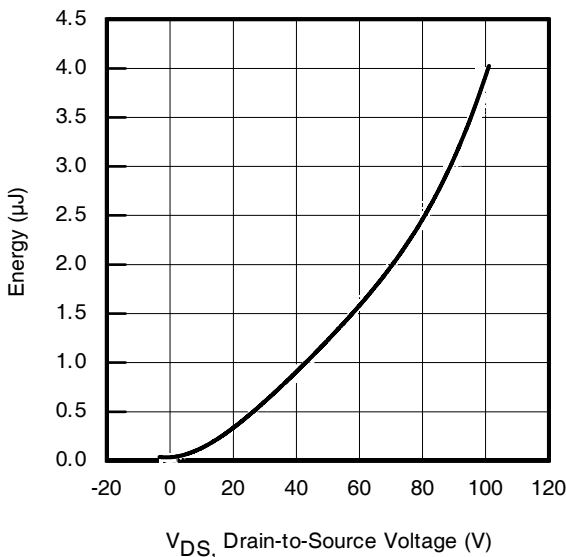

**Fig 11.** Typical  $C_{OSS}$  Stored Energy

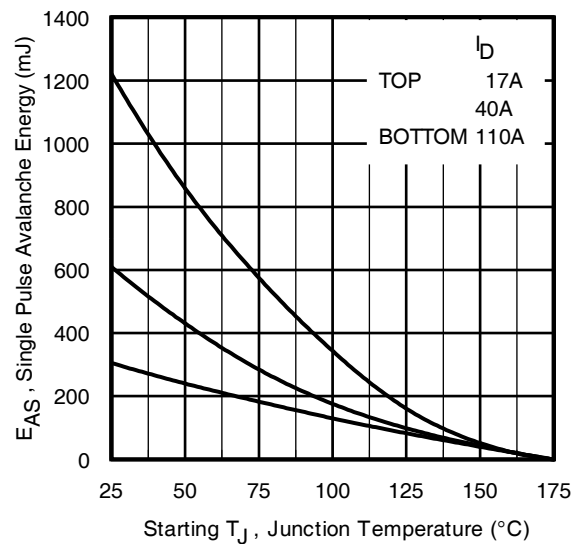

**Fig 12.** Maximum Avalanche Energy vs. Drain Current

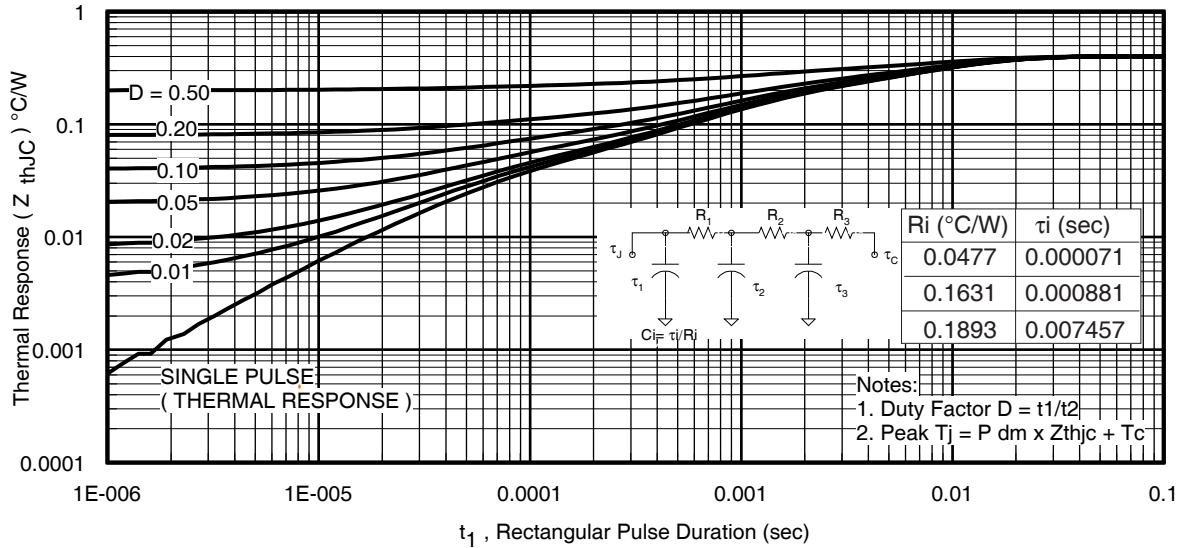

Fig 13. Maximum Effective Transient Thermal Impedance, Junction-to-Case

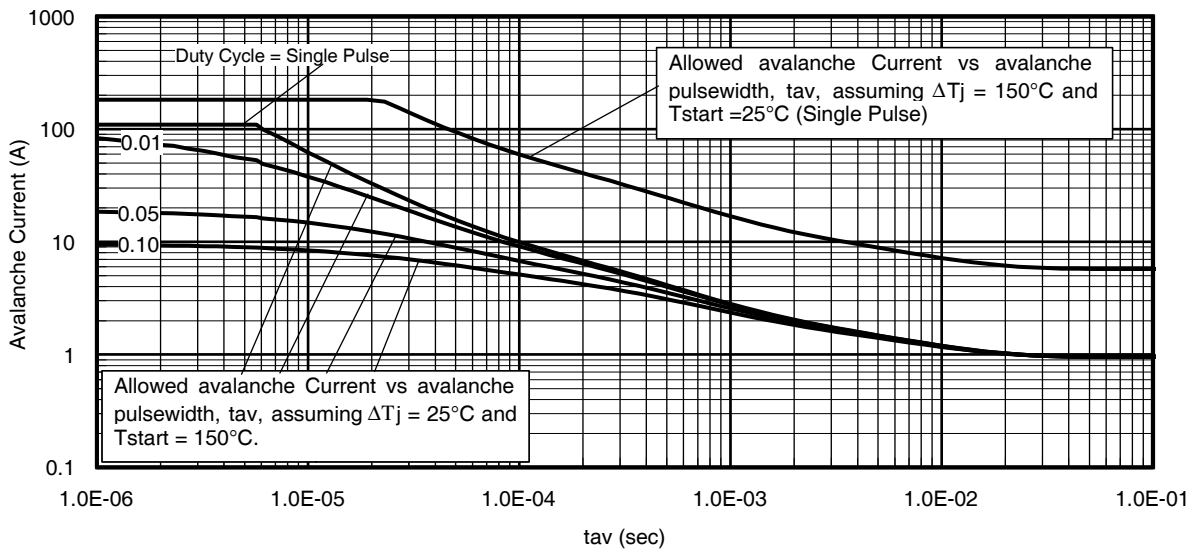
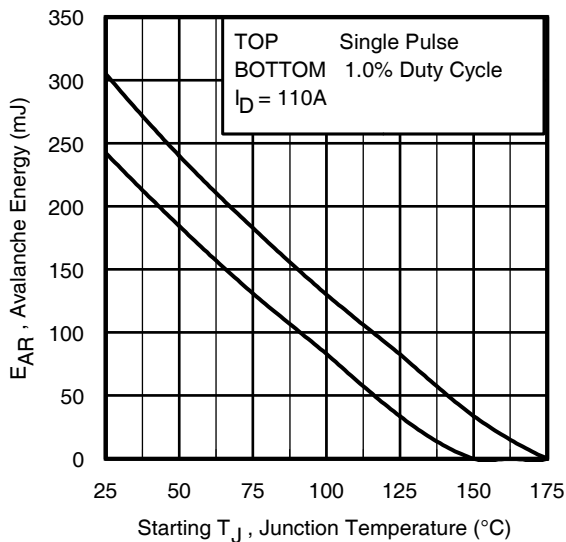

Fig 14. Typical Avalanche Current vs. Pulsewidth



**Notes on Repetitive Avalanche Curves, Figures 14, 15:**  
(For further info, see AN-1005 at [www.irf.com](http://www.irf.com))

1. Avalanche failures assumption:  
Purely a thermal phenomenon and failure occurs at a temperature far in excess of  $T_{jmax}$ . This is validated for every part type.
2. Safe operation in Avalanche is allowed as long as  $T_{jmax}$  is not exceeded.
3. Equation below based on circuit and waveforms shown in Figures 16a, 16b.
4.  $P_{D(ave)}$  = Average power dissipation per single avalanche pulse.
5. BV = Rated breakdown voltage (1.3 factor accounts for voltage increase during avalanche).
6.  $I_{av}$  = Allowable avalanche current.
7.  $\Delta T$  = Allowable rise in junction temperature, not to exceed  $T_{jmax}$  (assumed as 25°C in Figure 14, 15).  
 $t_{av}$  = Average time in avalanche.  
 $D$  = Duty cycle in avalanche =  $t_{av} \cdot f$   
 $Z_{thJC}(D, t_{av})$  = Transient thermal resistance, see Figures 13)

$$P_{D(ave)} = 1/2 (1.3 \cdot BV \cdot I_{av}) = \Delta T / Z_{thJC}$$

$$I_{av} = 2\Delta T / [1.3 \cdot BV \cdot Z_{th}]$$

$$E_{AS(AR)} = P_{D(ave)} \cdot t_{av}$$

Fig 15. Maximum Avalanche Energy vs. Temperature

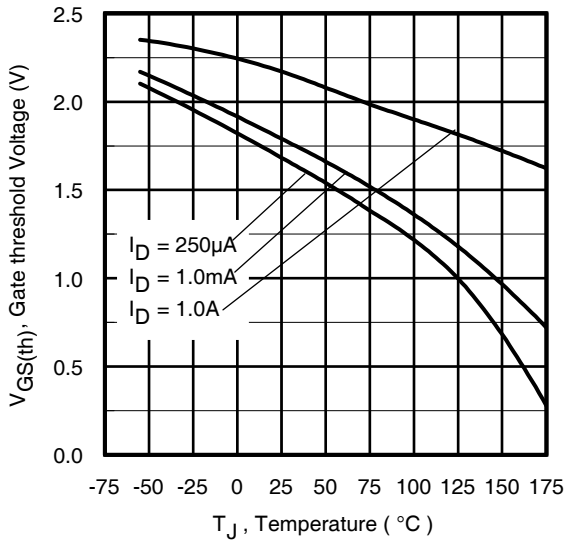

Fig 16. Threshold Voltage vs. Temperature

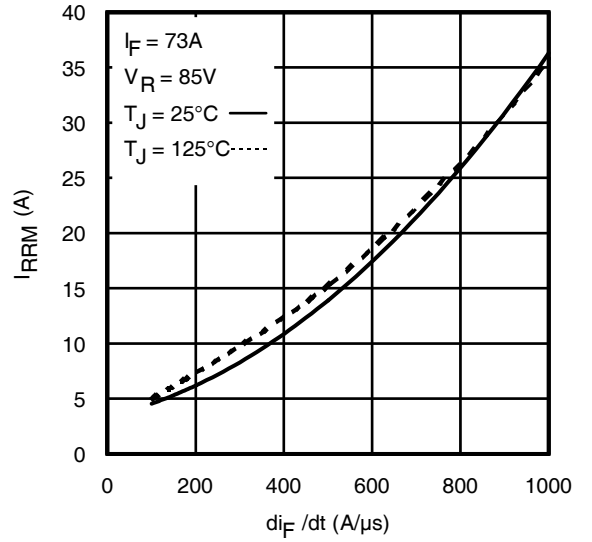

Fig. 17 - Typical Recovery Current vs.  $di_F/dt$

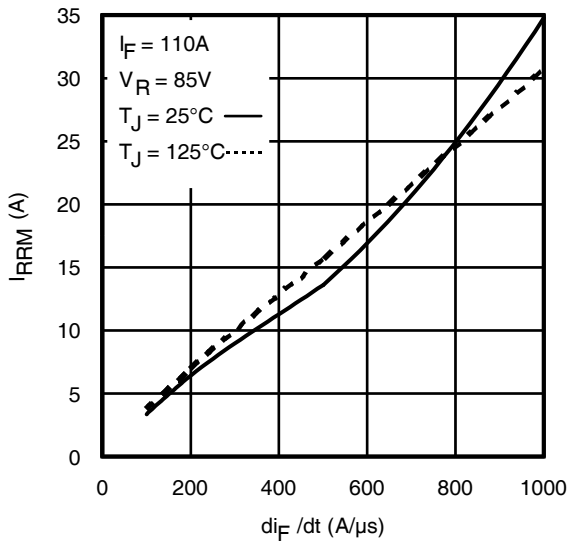

Fig. 18 - Typical Recovery Current vs.  $di_F/dt$

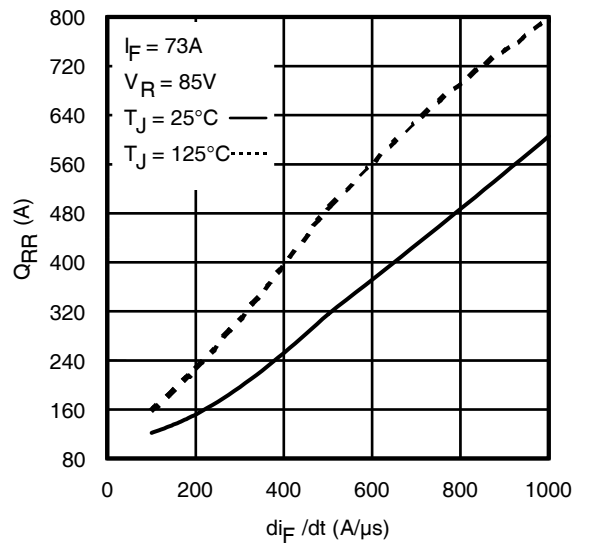

Fig. 19 - Typical Stored Charge vs.  $di_F/dt$

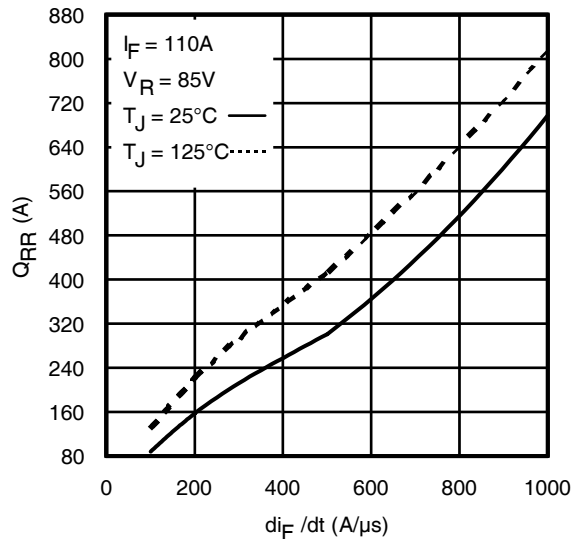

Fig. 20 - Typical Stored Charge vs.  $di_F/dt$



**Fig 21. Peak Diode Recovery dv/dt Test Circuit for N-Channel HEXFET® Power MOSFETs**



\*  $V_{GS} = 5V$  for Logic Level Devices



**Fig 22a. Unclamped Inductive Test Circuit**



**Fig 22b. Unclamped Inductive Waveforms**

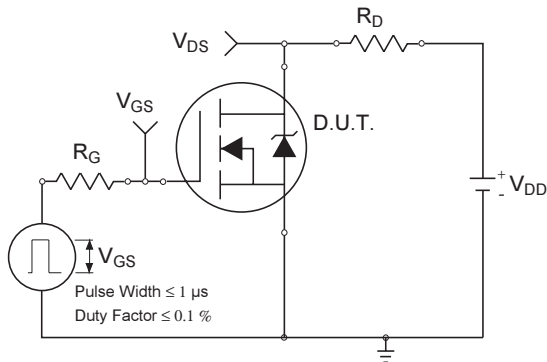

**Fig 23a. Switching Time Test Circuit**

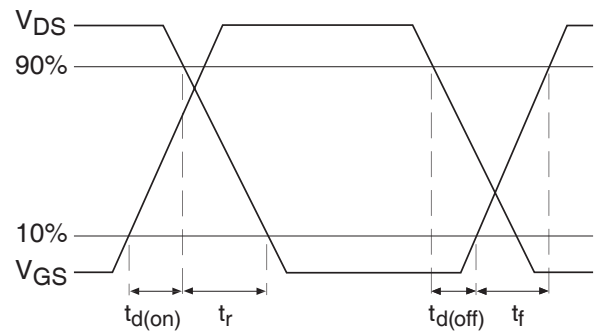

**Fig 23b. Switching Time Waveforms**



**Fig 24a. Gate Charge Test Circuit**



**Fig 24b. Gate Charge Waveform**

D<sup>2</sup>Pak (TO-263AB) Package Outline

Dimensions are shown in millimeters (inches)

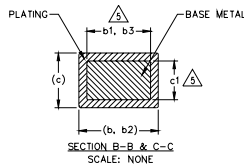
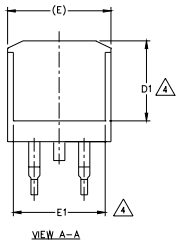
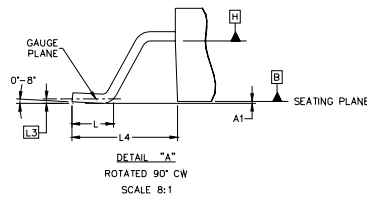
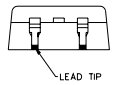
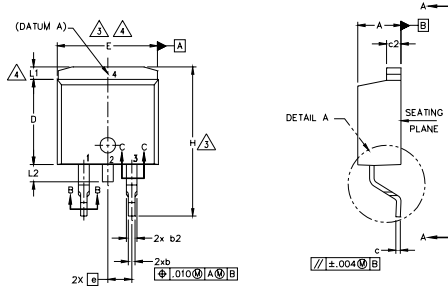

LEAD ASSIGNMENTS

DIODES

- 1.- ANODE (TWO DIE) / OPEN (ONE DIE)
- 2. 4.- CATHODE
- 3.- ANODE

HEXFET

- 1.- GATE
- 2. 4.- DRAIN
- 3.- SOURCE

IGBTs, CoPACK

- 1.- GATE
- 2. 4.- COLLECTOR
- 3.- EMITTER

SYMBOL	DIMENSIONS				NOTES
	MILLIMETERS		INCHES		
	MIN.	MAX.	MIN.	MAX.	
A	4.06	4.83	.160	.190	
A1	0.00	0.254	.000	.010	
b	0.51	0.99	.020	.039	
b1	0.51	0.89	.020	.035	5
b2	1.14	1.78	.045	.070	
b3	1.14	1.73	.045	.068	5
c	0.38	0.74	.015	.029	
c1	0.38	0.58	.015	.023	5
c2	1.14	1.65	.045	.065	
D	8.38	9.65	.330	.380	3
D1	6.86	-	.270	-	4
E	9.65	10.67	.380	.420	3,4
E1	6.22	-	.245	-	4
e	2.54 BSC		.100 BSC		
H	14.61	15.88	.575	.625	
L	1.78	2.79	.070	.110	
L1	-	1.65	-	.066	4
L2	-	1.78	-	.070	
L3	0.25 BSC		.010 BSC		
L4	4.78	5.28	.188	.208	

NOTES:

1. DIMENSIONING AND TOLERANCING PER ASME Y14.5M-1994
2. DIMENSIONS ARE SHOWN IN MILLIMETERS [INCHES].
3. DIMENSION D & E DO NOT INCLUDE MOLD FLASH. MOLD FLASH SHALL NOT EXCEED 0.127 [0.005"] PER SIDE. THESE DIMENSIONS ARE MEASURED AT THE OUTMOST EXTREMES OF THE PLASTIC BODY AT DATUM H.
4. THERMAL PAD CONTOUR OPTIONAL WITHIN DIMENSION E, L1, D1 & E1.
5. DIMENSION b1 AND c1 APPLY TO BASE METAL ONLY.
6. DATUM A & B TO BE DETERMINED AT DATUM PLANE H.
7. CONTROLLING DIMENSION: INCH.
8. OUTLINE CONFORMS TO JEDEC OUTLINE TO-263AB.

D<sup>2</sup>Pak (TO-263AB) Part Marking Information

EXAMPLE: THIS IS AN IRF530S WITH  
LOT CODE 8024  
ASSEMBLED ON WW 02, 2000  
IN THE ASSEMBLY LINE "L"

Note: "P" in assembly line position  
indicates "Lead - Free"

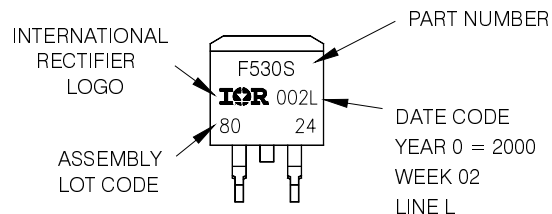

OR

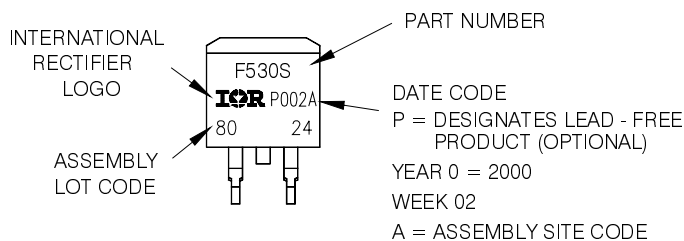

Note: For the most current drawing please refer to IR website at <http://www.irf.com/package/>



## TO-262 Package Outline

Dimensions are shown in millimeters (inches)

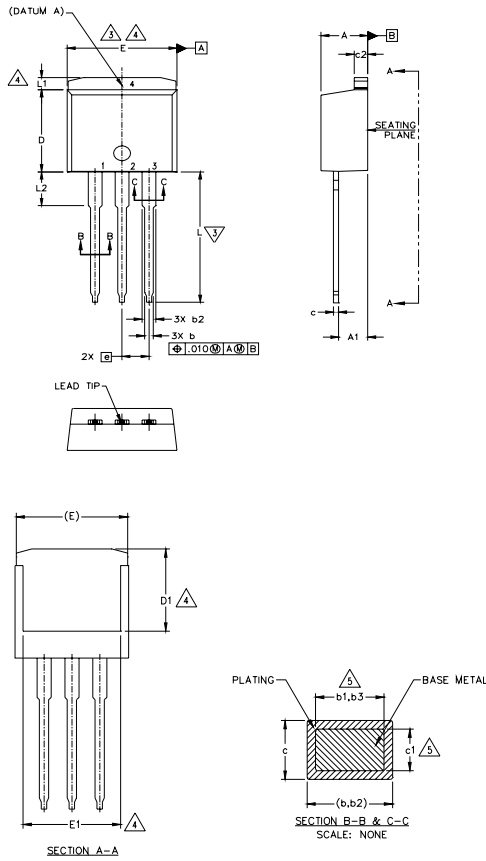

SYMBOL	DIMENSIONS				NOTES
	MILLIMETERS		INCHES		
	MIN.	MAX.	MIN.	MAX.	
A	4.06	4.83	.160	.190	5
A1	2.03	3.02	.080	.119	
b	0.51	0.99	.020	.039	5
b1	0.51	0.89	.020	.035	
b2	1.14	1.78	.045	.070	5
b3	1.14	1.73	.045	.068	
c	0.38	0.74	.015	.029	5
c1	0.38	0.58	.015	.023	
c2	1.14	1.65	.045	.065	5
D	8.38	9.65	.330	.380	
D1	6.86	—	.270	—	4
E	9.65	10.67	.380	.420	3,4
E1	6.22	—	.245	—	4
e	2.54 BSC		.100 BSC		4
L	13.46	14.10	.530	.555	
L1	—	1.65	—	.065	
L2	3.56	3.71	.140	.146	

- NOTES:
1. DIMENSIONING AND TOLERANCING PER ASME Y14.5M-1994
  2. DIMENSIONS ARE SHOWN IN MILLIMETERS (INCHES)
  3. DIMENSION D & E DO NOT INCLUDE MOLD FLASH. MOLD FLASH SHALL NOT EXCEED 0.127 (.005) PER SIDE. THESE DIMENSIONS ARE MEASURED AT THE OUTMOST EXTREMES OF THE PLASTIC BODY.
  4. THERMAL PAD CONTOUR OPTIONAL WITHIN DIMENSION L, L1, D1 & E1.
  5. DIMENSION b1 AND c1 APPLY TO BASE METAL ONLY.
  6. CONTROLLING DIMENSIONS: INCH.
  7. — OUTLINE CONFORMS TO JEDEC TO-262 EXCEPT A1(max.), b1(min.), AND D1(min.) WHERE DIMENSIONS DERIVED THE ACTUAL PACKAGE OUTLINE.

LEAD ASSIGNMENTS

IGBTs: CoPACK

- 1- GATE
- 2- COLLECTOR
- 3- EMITTER
- 4- COLLECTOR

HEXFET

- 1- GATE
- 2- DRAIN
- 3- SOURCE
- 4- DRAIN

DIODES

- 1- ANODE (NO DE) / OPEN (ONE DE)
- 2- CATHODE
- 3- ANODE
- 4- DRAIN

## TO-262 Part Marking Information

EXAMPLE: THIS IS AN IRL3103L  
LOT CODE 1789  
ASSEMBLED ON WW 19, 1997  
IN THE ASSEMBLY LINE 'C'

Note: "P" in assembly line position indicates "Lead - Free"

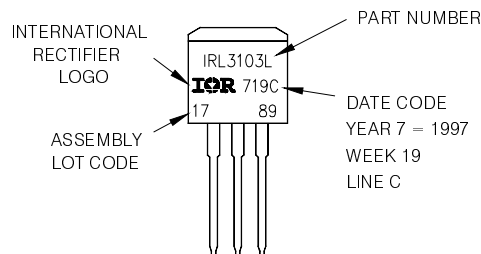

OR

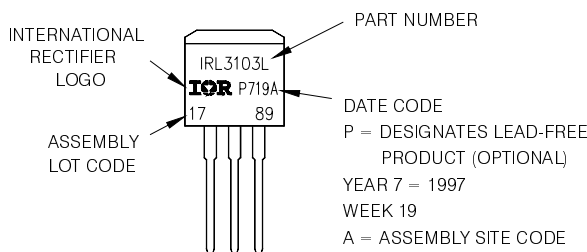

Note: For the most current drawing please refer to IR website at <http://www.irf.com/package/>

D<sup>2</sup>Pak (TO-263AB) Tape & Reel Information

Dimensions are shown in millimeters (inches)

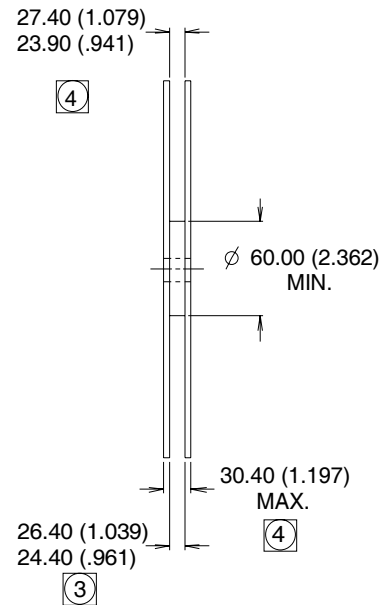
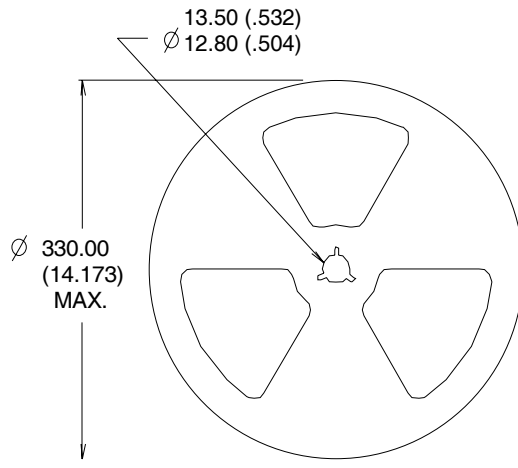
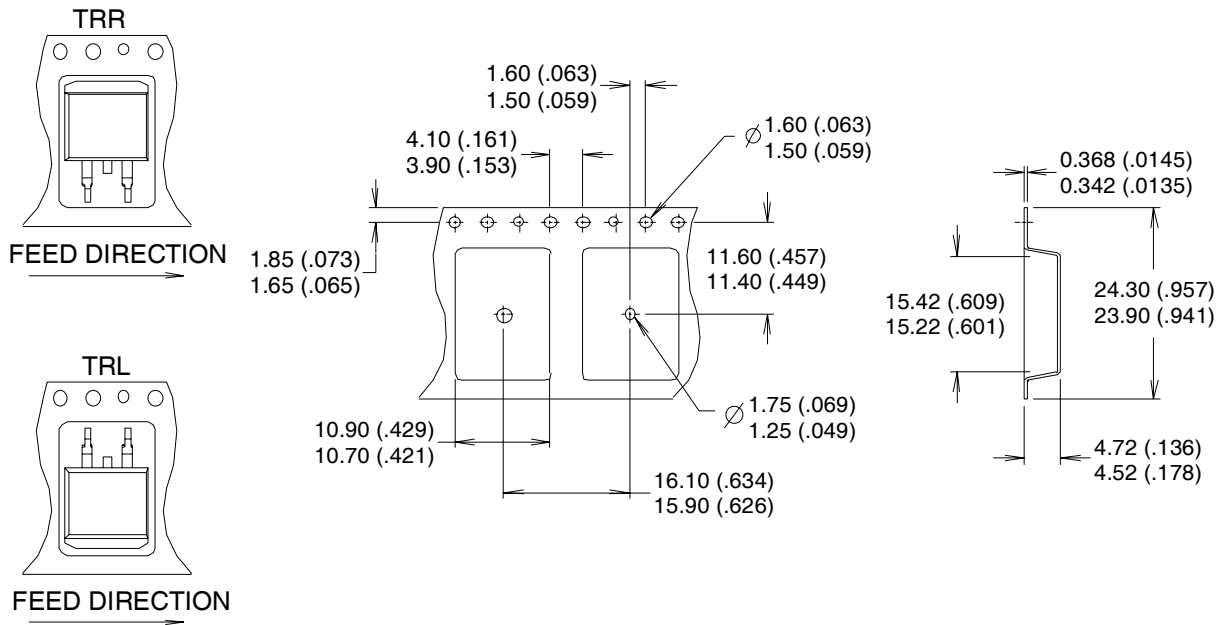

- NOTES :
1. CONFORMS TO EIA-418.
  2. CONTROLLING DIMENSION: MILLIMETER.
  - ③ DIMENSION MEASURED @ HUB.
  - ④ INCLUDES FLANGE DISTORTION @ OUTER EDGE.

Note: For the most current drawing please refer to IR website at <http://www.irf.com/package/>

Data and specifications subject to change without notice.  
This product has been designed and qualified for the Industrial market.  
Qualification Standards can be found on IR's Web site.

## **IMPORTANT NOTICE**

The information given in this document shall in no event be regarded as a guarantee of conditions or characteristics ("Beschaffheitsgarantie").

With respect to any examples, hints or any typical values stated herein and/or any information regarding the application of the product, Infineon Technologies hereby disclaims any and all warranties and liabilities of any kind, including without limitation warranties of non-infringement of intellectual property rights of any third party.

In addition, any information given in this document is subject to customer's compliance with its obligations stated in this document and any applicable legal requirements, norms and standards concerning customer's products and any use of the product of Infineon Technologies in customer's applications.

The data contained in this document is exclusively intended for technically trained staff. It is the responsibility of customer's technical departments to evaluate the suitability of the product for the intended application and the completeness of the product information given in this document with respect to such application.

For further information on the product, technology, delivery terms and conditions and prices please contact your nearest Infineon Technologies office ([www.infineon.com](http://www.infineon.com)).

## **WARNINGS**

Due to technical requirements products may contain dangerous substances. For information on the types in question please contact your nearest Infineon Technologies office.

Except as otherwise explicitly approved by Infineon Technologies in a written document signed by authorized representatives of Infineon Technologies, Infineon Technologies' products may not be used in any applications where a failure of the product or any consequences of the use thereof can reasonably be expected to result in personal injury.

# Mouser Electronics

Authorized Distributor

Click to View Pricing, Inventory, Delivery & Lifecycle Information:

[Infineon:](#)

[IRLS4030TRLPBF](#) [IRLSL4030PBF](#) [IRLS4030PBF](#)