

# International IR Rectifier

INSULATED GATE BIPOLAR TRANSISTOR WITH  
HYPERFAST DIODE

PD - 95970A

## IRG4BC30FD-SPbF

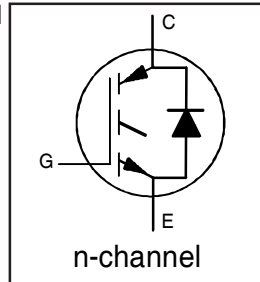
Fast CoPack IGBT

### Features

- Fast: optimized for medium operating frequencies (1-5 kHz in hard switching, >20kHz in resonant mode).
- Generation 4 IGBT design provides tighter parameter distribution and higher efficiency than Generation 3.
- IGBT co-packaged with HEXFRED™ ultrafast, ultra-soft recovery anti-parallel diodes for use in bridge configurations.
- Lead-Free

### Benefits

- Generation 4 IGBT's offer highest efficiency available.
- IGBT's optimized for specific application conditions.
- HEXFRED diodes optimized for performance with IGBT's. Minimized recovery characteristics require less/no snubbing.
- Designed to be a "drop-in" replacement for equivalent industry-standard Generation 3 IR IGBT's.



$V_{CES} = 600V$   
 $V_{CE(on) \text{ typ.}} = 1.59V$   
 @  $V_{GE} = 15V, I_C = 17A$



### Absolute Maximum Ratings

	Parameter	Max.	Units
$V_{CES}$	Collector-to-Emitter Voltage	600	V
$I_C @ T_C = 25^\circ C$	Continuous Collector Current	31	A
$I_C @ T_C = 100^\circ C$	Continuous Collector Current	17	
$I_{CM}$	Pulse Collector Current (Ref.Fig.C.T.5) ①	124	
$I_{LM}$	Clamped Inductive Load current ②	124	
$I_F @ T_C = 100^\circ C$	Diode Continuous Forward Current	12	
$I_{FM}$	Diode Maximum Forward Current	120	
$V_{GE}$	Gate-to-Emitter Voltage	$\pm 20$	V
$P_D @ T_C = 25^\circ C$	Maximum Power Dissipation	100	W
$P_D @ T_C = 100^\circ C$	Maximum Power Dissipation	42	
$T_J$	Operating Junction and	-55 to +150	$^\circ C$
$T_{STG}$	Storage Temperature Range		

### Thermal / Mechanical Characteristics

	Parameter	Min.	Typ.	Max.	Units
$R_{\theta JC}$	Junction-to-Case- IGBT	—	—	1.2	$^\circ C/W$
$R_{\theta CS}$	Case-to-Sink, flat, greased surface	—	0.50	—	
$R_{\theta JA}$	Junction-to-Ambient (PCB Mounted, steady state) ③	—	—	40	
Wt	Weight	—	2.0 (0.07)	—	g (oz.)

# IRG4BC30FD-SPbF

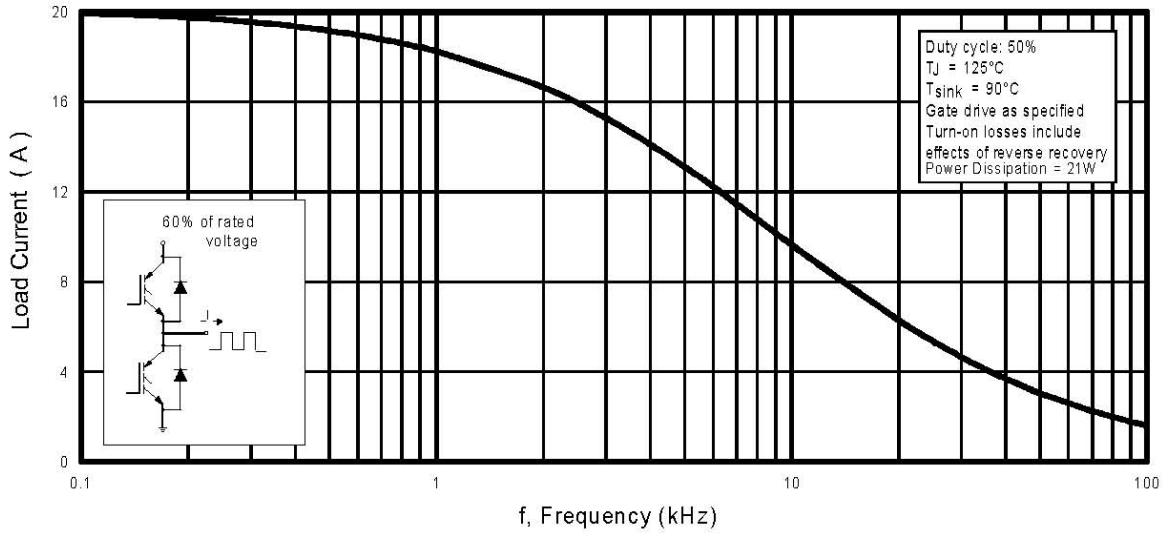


## Electrical Characteristics @ T<sub>J</sub> = 25°C (unless otherwise specified)

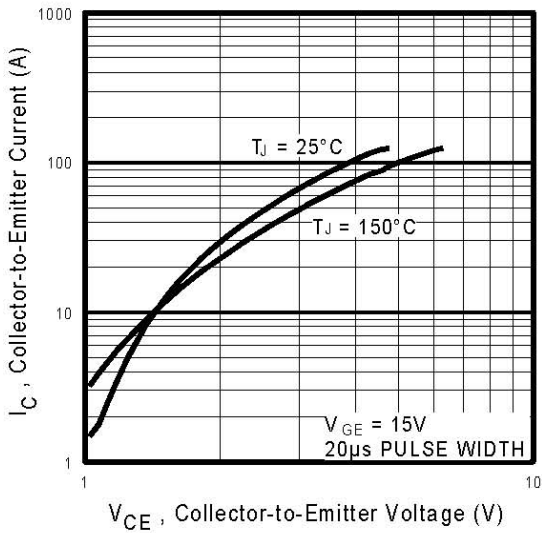
	Parameter	Min.	Typ.	Max.	Units	Conditions
V <sub>(BR)CES</sub>	Collector-to-Emitter Breakdown Voltage ③	600	—	—	V	V <sub>GE</sub> = 0V, I <sub>C</sub> = 250μA
ΔV <sub>(BR)CES</sub> /ΔT <sub>J</sub>	Temperature Coeff. of Breakdown Voltage	—	0.69	—	V/°C	V <sub>GE</sub> = 0V, I <sub>C</sub> = 1mA
V <sub>CE(on)</sub>	Collector-to-Emitter Voltage	—	1.59	1.8	V	I <sub>C</sub> = 17A V <sub>GE</sub> = 15V
		—	1.99	—		I <sub>C</sub> = 31A See Fig. 2, 5
		—	1.7	—		I <sub>C</sub> = 17A, T <sub>J</sub> = 150°C
V <sub>GE(th)</sub>	Gate Threshold Voltage	3.0	—	6.0	V	V <sub>CE</sub> = V <sub>GE</sub> , I <sub>C</sub> = 250μA
ΔV <sub>GE(th)</sub> /ΔT <sub>J</sub>	Threshold Voltage temp. coefficient	—	-11	—	mV/°C	V <sub>CE</sub> = V <sub>GE</sub> , I <sub>C</sub> = 250μA
g <sub>fe</sub>	Forward Transconductance ④	6.1	10	—	S	V <sub>CE</sub> = 100V, I <sub>C</sub> = 17A
I <sub>CES</sub>	Zero Gate Voltage Collector Current	—	—	250	μA	V <sub>GE</sub> = 0V, V <sub>CE</sub> = 600V
		—	—	2500		V <sub>GE</sub> = 0V, V <sub>CE</sub> = 600V, T <sub>J</sub> = 150°C
V <sub>FM</sub>	Diode Forward Voltage Drop	—	1.4	1.7	V	I <sub>F</sub> = 12A See Fig. 13
		—	1.3	1.6		I <sub>F</sub> = 12A, T <sub>J</sub> = 150°C
I <sub>GES</sub>	Gate-to-Emitter Leakage Current	—	—	±100	nA	V <sub>GE</sub> = ±20V

## Switching Characteristics @ T<sub>J</sub> = 25°C (unless otherwise specified)

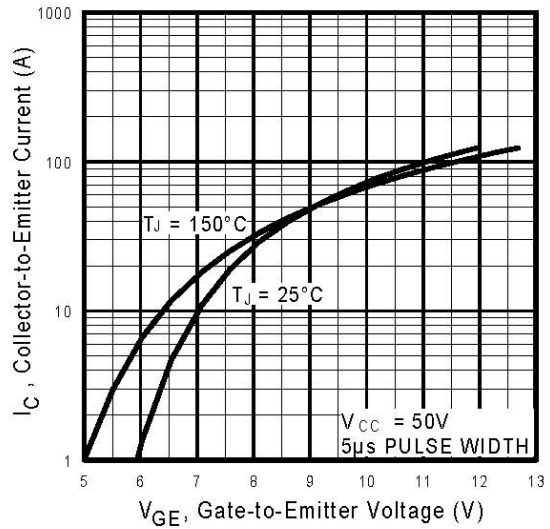
	Parameter	Min.	Typ.	Max.	Units	Conditions
Q <sub>g</sub>	Total Gate Charge (turn-on)	—	51	77	nC	I <sub>C</sub> = 17A
Q <sub>ge</sub>	Gate-to-Emitter Charge (turn-on)	—	7.9	12		V <sub>CC</sub> = 400V See Fig. 8
Q <sub>gc</sub>	Gate-to-Collector Charge (turn-on)	—	19	28		V <sub>GE</sub> = 15V
t <sub>d(on)</sub>	Turn-On delay time	—	42	—	ns	T <sub>J</sub> = 25°C
t <sub>r</sub>	Rise time	—	26	—		I <sub>C</sub> = 17A, V <sub>CC</sub> = 480V
t <sub>d(off)</sub>	Turn-Off delay time	—	230	350		V <sub>GE</sub> = 15V, R <sub>G</sub> = 23Ω
t <sub>f</sub>	Fall time	—	160	230		Energy losses include "tail" and diode reverse recovery.
E <sub>on</sub>	Turn-On Switching Loss	—	0.63	—	mJ	See Fig. 9, 10, 11, 18
E <sub>off</sub>	Turn-Off Switching Loss	—	1.39	—		
E <sub>ts</sub>	Total Switching Loss	—	2.02	3.9		
t <sub>d(on)</sub>	Turn-On delay time	—	42	—	ns	T <sub>J</sub> = 150°C See Fig. 9,10,11,18
t <sub>r</sub>	Rise time	—	27	—		I <sub>C</sub> = 17A, V <sub>CC</sub> = 480V
t <sub>d(off)</sub>	Turn-Off delay time	—	310	—		V <sub>GE</sub> = 15V, R <sub>G</sub> = 23Ω
t <sub>f</sub>	Fall time	—	310	—		Energy losses include "tail" and diode reverse recovery.
E <sub>ts</sub>	Total Switching Loss	—	3.2	—	mJ	
L <sub>E</sub>	Internal Emitter Inductance	—	7.5	—	nH	Measured 5mm from package
C <sub>ies</sub>	Input Capacitance	—	1100	—	pF	V <sub>GE</sub> = 0V
C <sub>oes</sub>	Output Capacitance	—	74	—		V <sub>CC</sub> = 30V See Fig. 7
C <sub>res</sub>	Reverse Transfer Capacitance	—	14	—		f = 1.0MHz
t <sub>rr</sub>	Diode Reverse Recovery Time	—	42	60	ns	T <sub>J</sub> = 25°C See Fig. 14
		—	80	120		T <sub>J</sub> = 125°C
I <sub>rr</sub>	Diode Peak Reverse Recovery Current	—	3.5	6.0	A	T <sub>J</sub> = 25°C See Fig. 15
		—	5.6	10		T <sub>J</sub> = 125°C
Q <sub>rr</sub>	Diode Reverse Recovery Charge	—	80	180	nC	T <sub>J</sub> = 25°C See Fig. 16
		—	220	600		T <sub>J</sub> = 125°C
di <sub>(rec)M</sub> /dt	Diode Peak Rate of Fall of Recovery During t <sub>b</sub>	—	180	—	A/μs	T <sub>J</sub> = 25°C See Fig. 17
		—	120	—		T <sub>J</sub> = 125°C



**Fig. 1** - Typical Load Current vs. Frequency  
 (Load Current =  $I_{RMS}$  of fundamental)



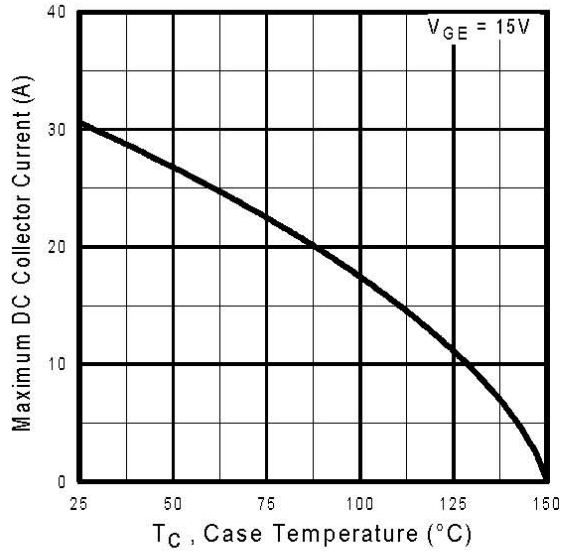
**Fig. 2** - Typical Output Characteristics



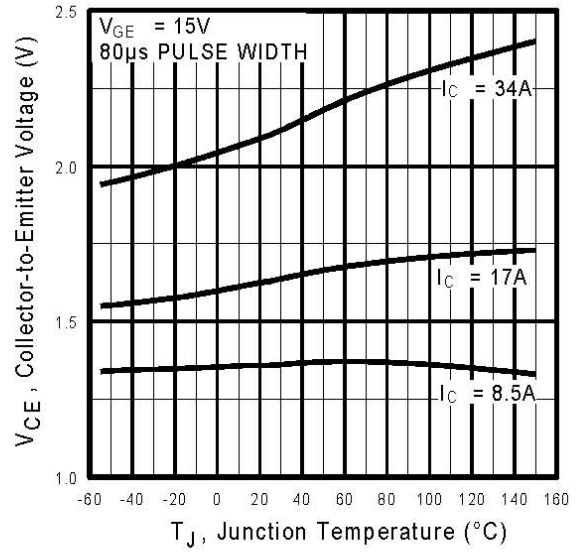
**Fig. 3** - Typical Transfer Characteristics

# IRG4BC30FD-SPbF

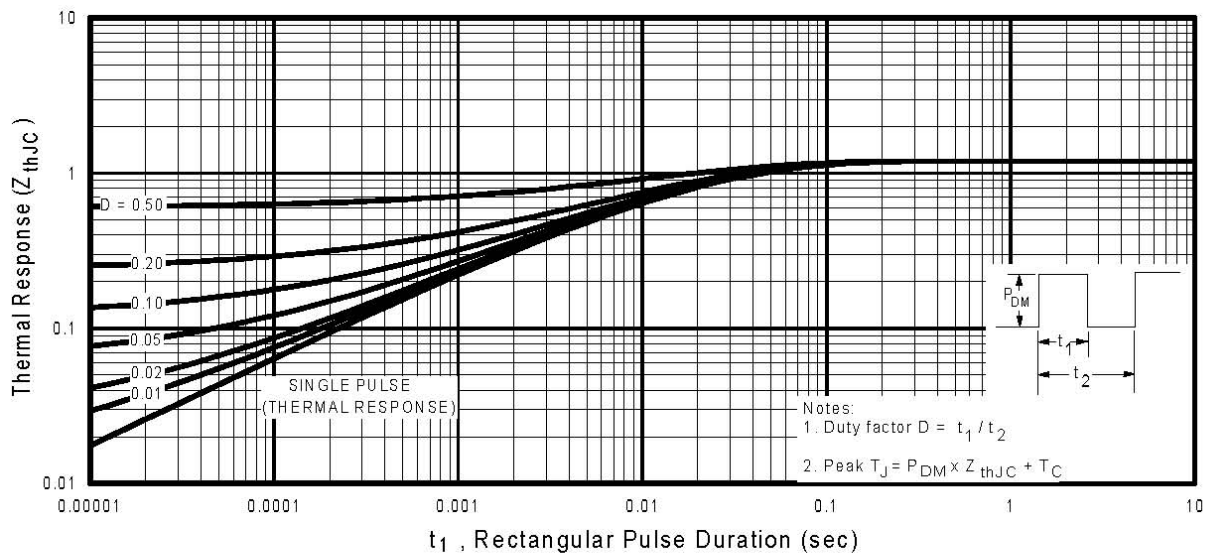
International  
**IR** Rectifier



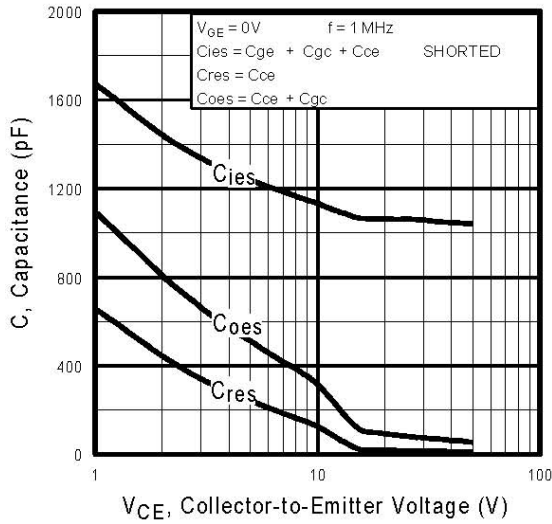
**Fig. 4 -** Maximum Collector Current vs. Case Temperature



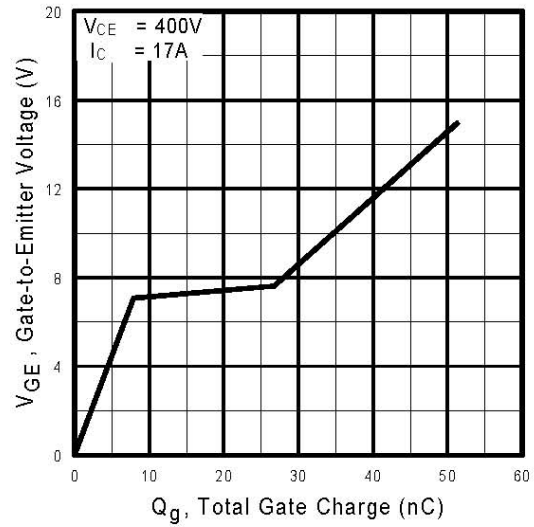
**Fig. 5 -** Typical Collector-to-Emitter Voltage vs. Junction Temperature



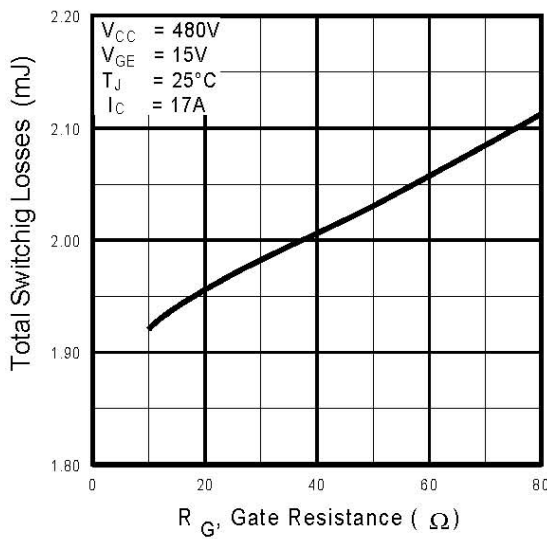
**Fig. 6 -** Maximum Effective Transient Thermal Impedance, Junction-to-Case



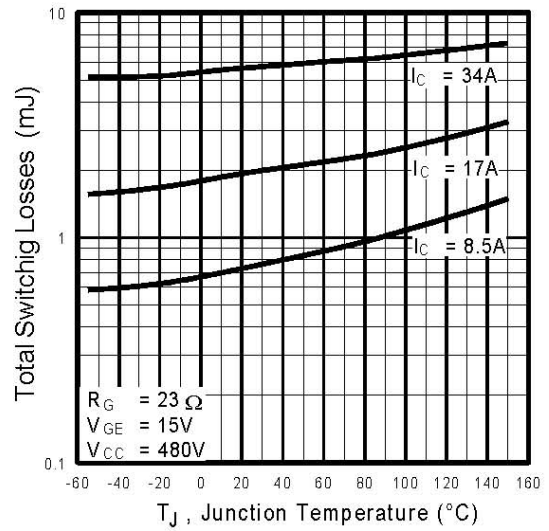
**Fig. 7** - Typical Capacitance vs. Collector-to-Emitter Voltage



**Fig. 8** - Typical Gate Charge vs. Gate-to-Emitter Voltage

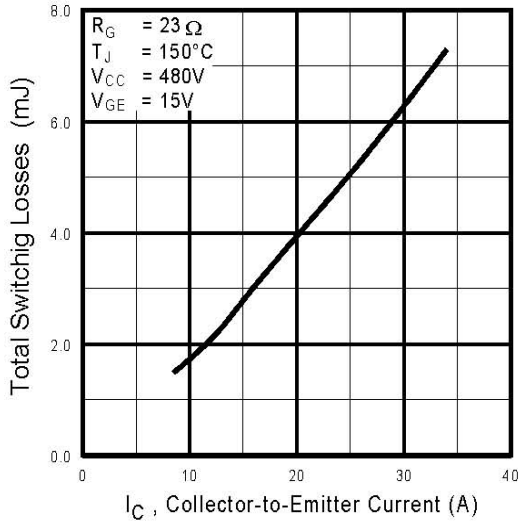


**Fig. 9** - Typical Switching Losses vs. Gate Resistance

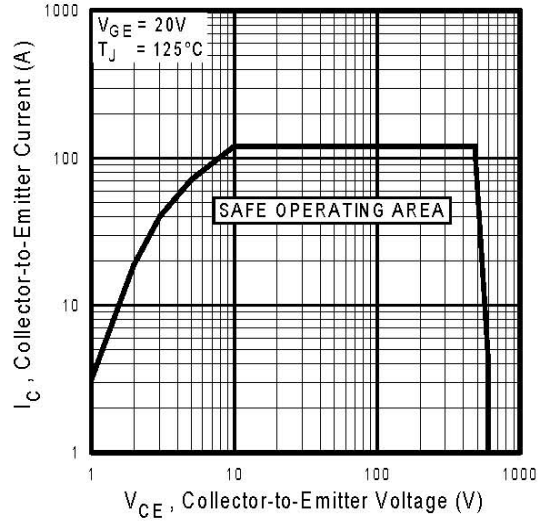


**Fig. 10** - Typical Switching Losses vs. Junction Temperature

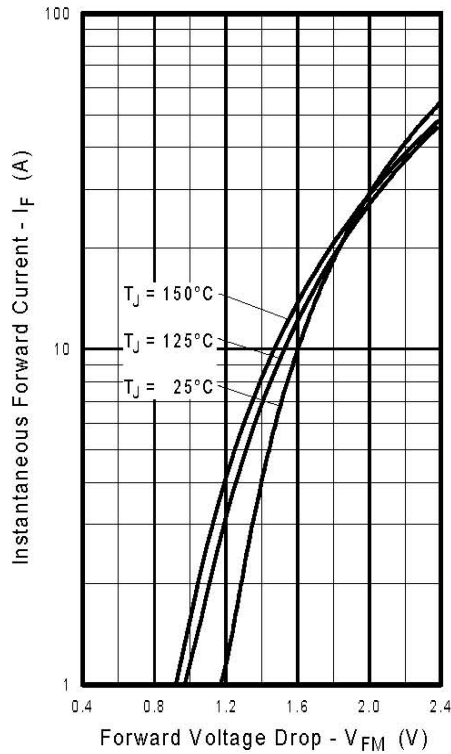
# IRG4BC30FD-SPbF



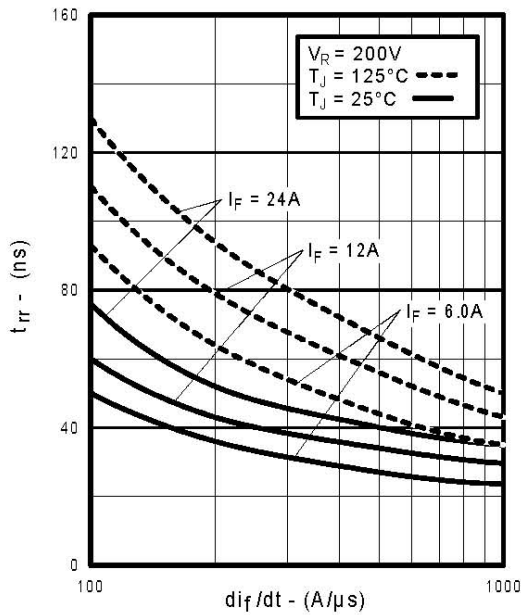
**Fig. 11** - Typical Switching Losses vs. Collector-to-Emitter Current



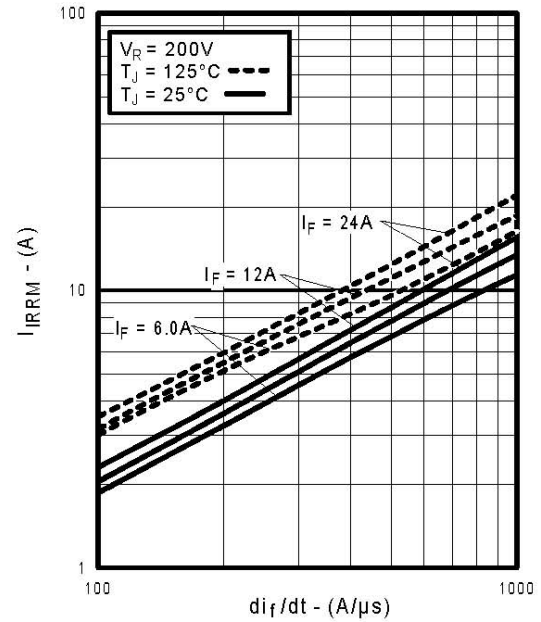
**Fig. 12** - Turn-Off SOA



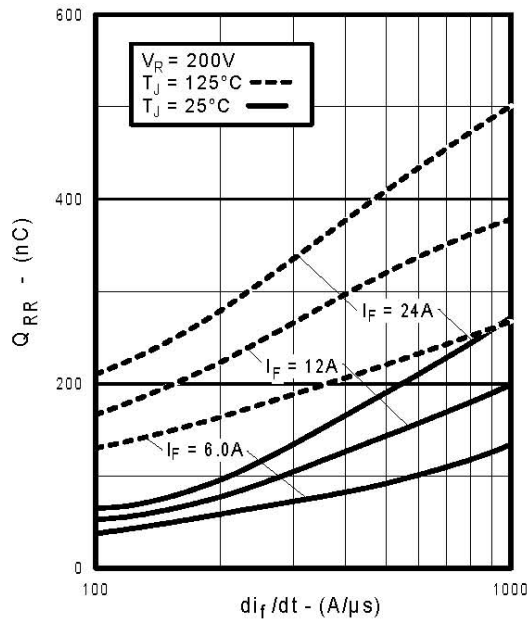
**Fig. 13** - Maximum Forward Voltage Drop vs. Instantaneous Forward Current



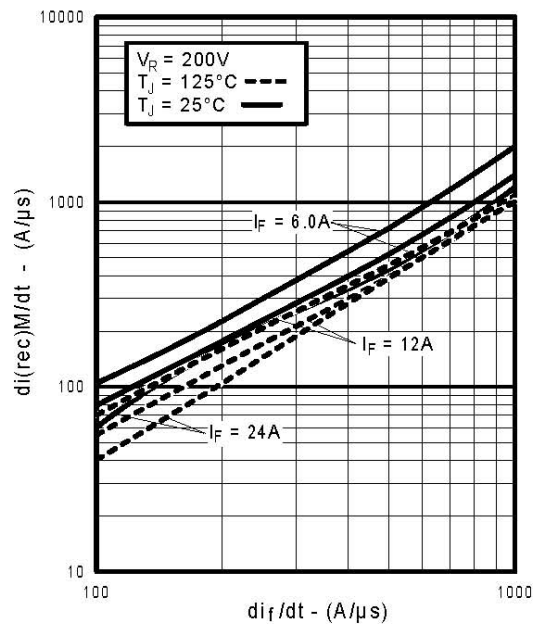
**Fig. 14** - Typical Reverse Recovery vs.  $di_f/dt$



**Fig. 15** - Typical Recovery Current vs.  $di_f/dt$

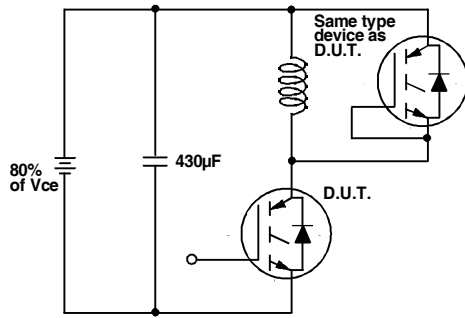


**Fig. 16** - Typical Stored Charge vs.  $di_f/dt$

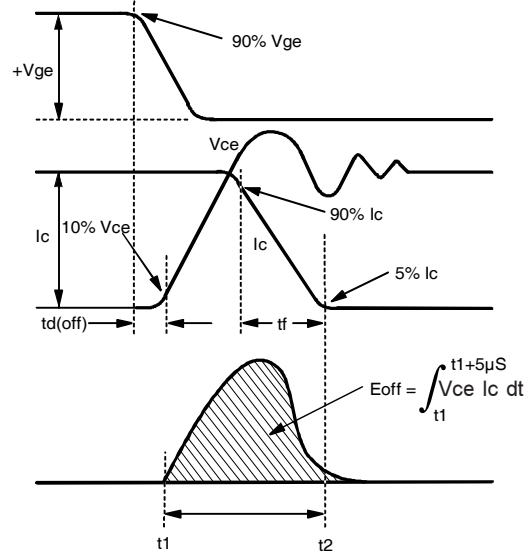


**Fig. 17** - Typical  $di_{(rec)M}/dt$  vs.  $di_f/dt$

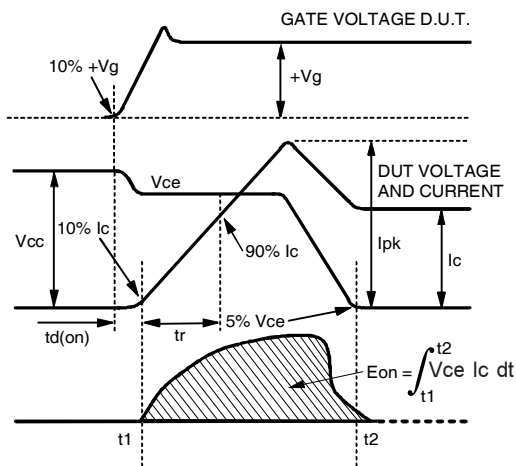
# IRG4BC30FD-SPbF



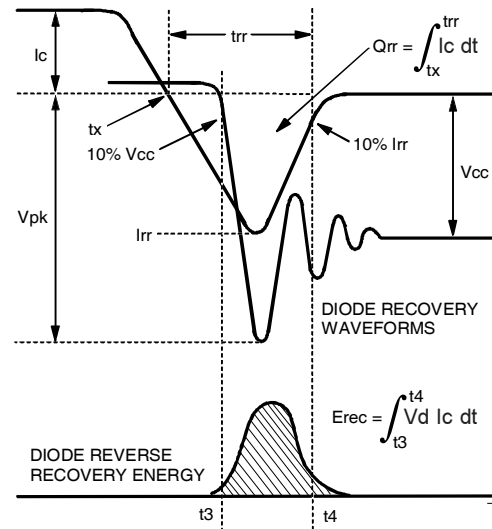
**Fig. 18a** - Test Circuit for Measurement of  $I_{LM}$ ,  $E_{on}$ ,  $E_{off(diode)}$ ,  $t_{rr}$ ,  $Q_{rr}$ ,  $I_{rr}$ ,  $t_{d(on)}$ ,  $t_r$ ,  $t_{d(off)}$ ,  $t_f$



**Fig. 18b** - Test Waveforms for Circuit of Fig. 18a, Defining  $E_{off}$ ,  $t_{d(off)}$ ,  $t_f$

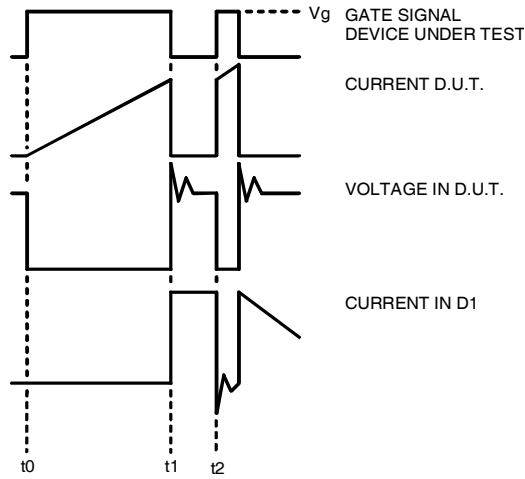


**Fig. 18c** - Test Waveforms for Circuit of Fig. 18a, Defining  $E_{on}$ ,  $t_{d(on)}$ ,  $t_r$

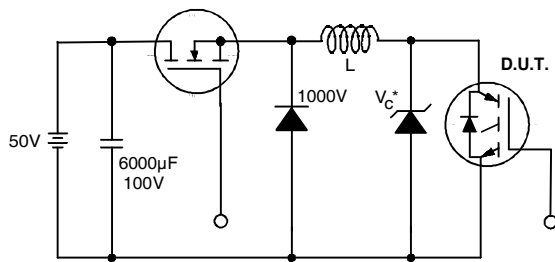


**Fig. 18d** - Test Waveforms for Circuit of Fig. 18a, Defining  $E_{rec}$ ,  $t_{rr}$ ,  $Q_{rr}$ ,  $I_{rr}$

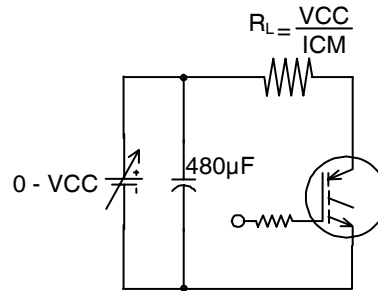




**Fig.18e** - Macro Waveforms for Figure 18a's Test Circuit



**Fig. 19** - Clamped Inductive Load Test Circuit



Pulsed Collector Current  
 Test Circuit

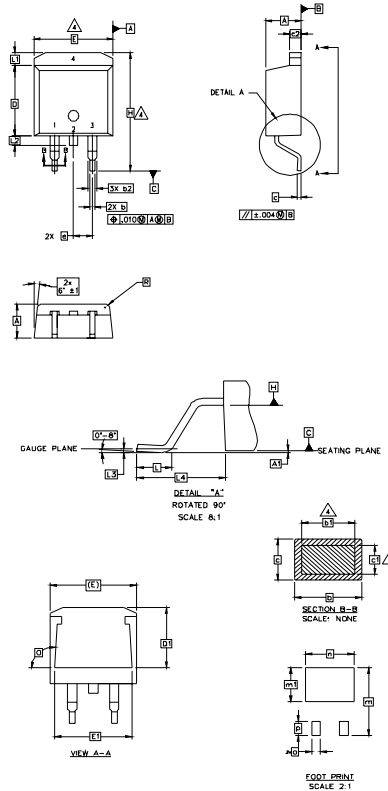
**Fig. 20** - Pulsed Collector Current  
 Test Circuit

# IRG4BC30FD-SPbF



## D<sup>2</sup>Pak Package Outline

Dimensions are shown in millimeters (inches)



**NOTES:**

1. DIMENSIONING AND TOLERANCING PER ASME Y14.5M-1994
2. DIMENSIONS ARE SHOWN IN MILLIMETERS [INCHES].
3. DIMENSION D & E DO NOT INCLUDE MOLD FLASH. MOLD FLASH SHALL NOT EXCEED 0.127 [0.005"] PER SIDE. THESE DIMENSIONS ARE MEASURED AT THE OUTMOST EXTREMES OF THE PLASTIC BODY.
4. DIMENSION b1 AND c1 APPLY TO BASE METAL ONLY.
5. CONTROLLING DIMENSION: INCH.

SYMBOL	DIMENSIONS				NOTES
	MILLIMETERS		INCHES		
	MIN.	MAX.	MIN.	MAX.	
A	4.06	4.83	.160	.190	
A1	0.00	0.254	.000	.010	
b	0.51	0.99	.020	.039	4
b1	0.51	0.89	.020	.035	
b2	1.14	1.78	.045	.070	
c	0.38	0.74	.015	.029	
c1	0.38	0.58	.015	.023	4
c2	1.14	1.65	.045	.065	
D	8.51	9.65	.335	.380	3
D1	6.86		.270		
E	9.65	10.67	.380	.420	3
E1	6.22		.245		
e	2.54 BSC		.100 BSC		
H	14.61	15.88	.575	.625	
L	1.78	2.79	.070	.110	
L1		1.65		.065	
L2	1.27	1.78	.050	.070	
L3	0.25 BSC		.010 BSC		
L4	4.78	5.28	.188	.208	
m	17.78		.700		
m1	8.89		.350		
n	11.43		.450		
o	2.08		.082		
p	3.81		.150		
R	0.51	0.71	.020	.028	
theta	90°	93°	90°	93°	

**LEAD ASSIGNMENTS**

**HEXFET**

- 1.- GATE
- 2, 4.- DRAIN
- 3.- SOURCE

**IGBTs, CoPACK**

- 1.- GATE
- 2, 4.- COLLECTOR
- 3.- EMITTER

**DIODES**

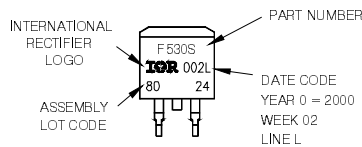
- 1.- ANODE \*
- 2, 4.- CATHODE
- 3.- ANODE

\* PART DEPENDENT.

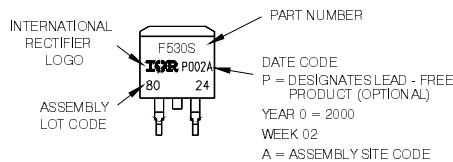
## D<sup>2</sup>Pak Part Marking Information

EXAMPLE: THIS IS AN IRF530S WITH  
LOT CODE 8024  
ASSEMBLED ON WW 02, 2000  
IN THE ASSEMBLY LINE 'L'

Note: "P" in assembly line position  
indicates "Lead - Free"



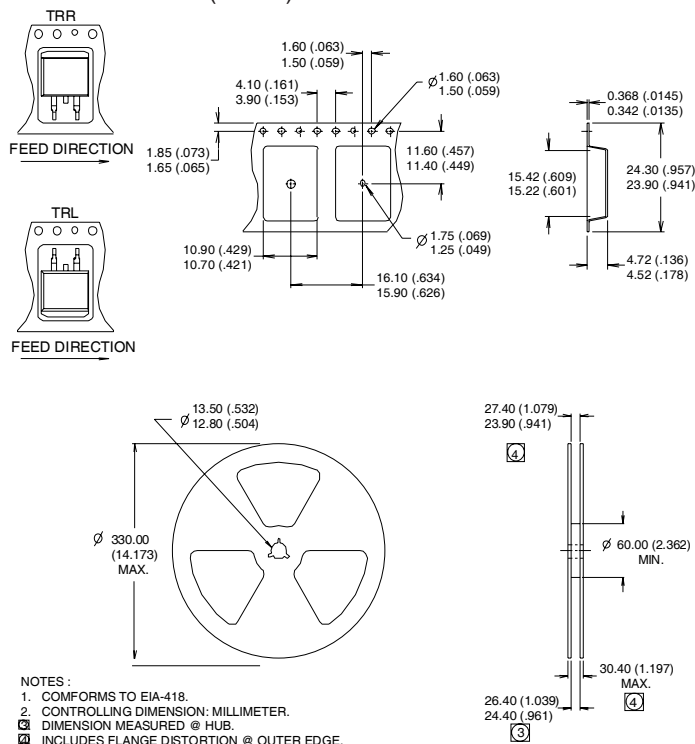
OR



Note: For the most current drawing please refer to IR website at <http://www.irf.com/package/>

## D<sup>2</sup>Pak Tape & Reel Information

Dimensions are shown in millimeters (inches)



### Notes:

- ① Repetitive rating:  $V_{GE}=20V$ ; pulse width limited by maximum junction temperature (figure 20).
- ②  $V_{CC}=80\%(V_{CES})$ ,  $V_{GE}=20V$ ,  $L=10\mu H$ ,  $R_G = 23\Omega$  (figure 19).
- ③ Pulse width  $\leq 80\mu s$ ; duty factor  $\leq 0.1\%$ .
- ④ Pulse width  $5.0\mu s$ , single shot.
- ⑤ When mounted on 1" square PCB (FR-4 or G-10 Material).

Data and specifications subject to change without notice.

# Mouser Electronics

Authorized Distributor

Click to View Pricing, Inventory, Delivery & Lifecycle Information:

[Infineon:](#)

[IRG4BC30FDSTRRP](#)