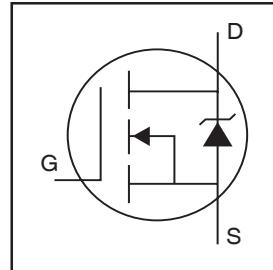


# IRFZ34NPbF

HEXFET® Power MOSFET

- Advanced Process Technology
- Ultra Low On-Resistance
- Dynamic dv/dt Rating
- 175°C Operating Temperature
- Fast Switching
- Ease of Paralleling
- Lead-Free

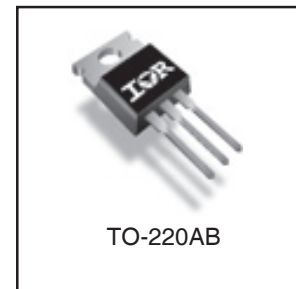


$V_{DSS} = 55V$   
 $R_{DS(on)} = 0.040\Omega$   
 $I_D = 29A$

## Description

Fifth Generation HEXFETs from International Rectifier utilize advanced processing techniques to achieve the lowest possible on-resistance per silicon area. This benefit, combined with the fast switching speed and ruggedized device design that HEXFET Power MOSFETs are well known for, provides the designer with an extremely efficient device for use in a wide variety of applications.

The TO-220 package is universally preferred for all commercial-industrial applications at power dissipation levels to approximately 50 watts. The low thermal resistance and low package cost of the TO-220 contribute to its wide acceptance throughout the industry.



## Absolute Maximum Ratings

	Parameter	Max.	Units
$I_D @ T_C = 25^\circ C$	Continuous Drain Current, $V_{GS} @ 10V$	29	A
$I_D @ T_C = 100^\circ C$	Continuous Drain Current, $V_{GS} @ 10V$	20	
$I_{DM}$	Pulsed Drain Current ①	100	
$P_D @ T_C = 25^\circ C$	Power Dissipation	68	W
	Linear Derating Factor	0.45	W/°C
$V_{GS}$	Gate-to-Source Voltage	$\pm 20$	V
$E_{AS}$	Single Pulse Avalanche Energy②	65	mJ
$I_{AR}$	Avalanche Current③	16	A
$E_{AR}$	Repetitive Avalanche Energy④	6.8	mJ
dv/dt	Peak Diode Recovery dv/dt ⑤	5.0	V/ns
$T_J$	Operating Junction and	-55 to + 175	°C
$T_{STG}$	Storage Temperature Range		
	Soldering Temperature, for 10 seconds		
	Mounting torque, 6-32 or M3 srew	10 lbf•in (1.1N•m)	

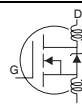
## Thermal Resistance

	Parameter	Min.	Typ.	Max.	Units
$R_{\theta JC}$	Junction-to-Case	—	—	2.2	°C/W
$R_{\theta CS}$	Case-to-Sink, Flat, Greased Surface	—	0.50	—	
$R_{\theta JA}$	Junction-to-Ambient	—	—	62	

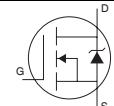
# IRFZ34NPbF

International  
IR Rectifier

## Electrical Characteristics @ $T_J = 25^\circ\text{C}$ (unless otherwise specified)

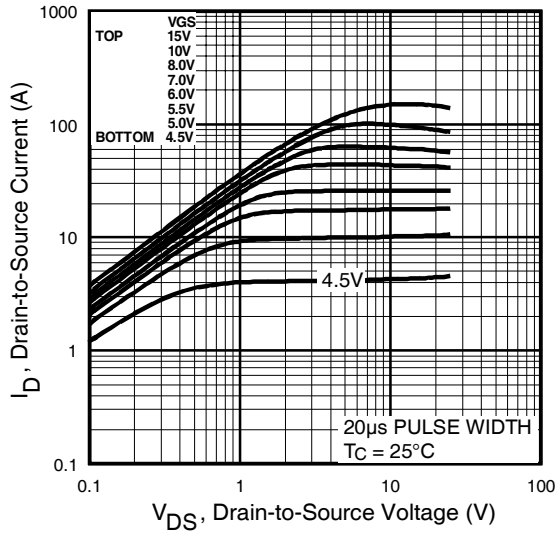
	Parameter	Min.	Typ.	Max.	Units	Conditions
$V_{(BR)DSS}$	Drain-to-Source Breakdown Voltage	55	—	—	V	$V_{GS} = 0V, I_D = 250\mu A$
$\Delta V_{(BR)DSS}/\Delta T_J$	Breakdown Voltage Temp. Coefficient	—	0.052	—	V/°C	Reference to $25^\circ\text{C}, I_D = 1\text{mA}$
$R_{DS(ON)}$	Static Drain-to-Source On-Resistance	—	—	0.040	$\Omega$	$V_{GS} = 10V, I_D = 16A$ ②
$V_{GS(th)}$	Gate Threshold Voltage	2.0	—	4.0	V	$V_{DS} = V_{GS}, I_D = 250\mu A$
$g_{fs}$	Forward Transconductance	6.5	—	—	S	$V_{DS} = 25V, I_D = 16A$
$I_{DSS}$	Drain-to-Source Leakage Current	—	—	25	$\mu A$	$V_{DS} = 55V, V_{GS} = 0V$
		—	—	250		$V_{DS} = 44V, V_{GS} = 0V, T_J = 150^\circ\text{C}$
$I_{GSS}$	Gate-to-Source Forward Leakage	—	—	100	nA	$V_{GS} = 20V$
	Gate-to-Source Reverse Leakage	—	—	-100		$V_{GS} = -20V$
$Q_g$	Total Gate Charge	—	—	34	nC	$I_D = 16A$
$Q_{gs}$	Gate-to-Source Charge	—	—	6.8		$V_{DS} = 44V$
$Q_{gd}$	Gate-to-Drain ("Miller") Charge	—	—	14		$V_{GS} = 10V$ , See Fig. 6 and 13 ④
$t_{d(on)}$	Turn-On Delay Time	—	7.0	—	ns	$V_{DD} = 28V$
$t_r$	Rise Time	—	49	—		$I_D = 16A$
$t_{d(off)}$	Turn-Off Delay Time	—	31	—		$R_G = 18\Omega$
$t_f$	Fall Time	—	40	—		$R_D = 1.8\Omega$ , See Fig. 10 ④
$L_D$	Internal Drain Inductance	—	4.5	—	nH	Between lead, 6mm (0.25in.) from package and center of die contact
$L_S$	Internal Source Inductance	—	7.5	—		
$C_{ISS}$	Input Capacitance	—	700	—	pF	$V_{GS} = 0V$
$C_{OSS}$	Output Capacitance	—	240	—		$V_{DS} = 25V$
$C_{RSS}$	Reverse Transfer Capacitance	—	100	—		$f = 1.0\text{MHz}$ , See Fig. 5

## Source-Drain Ratings and Characteristics

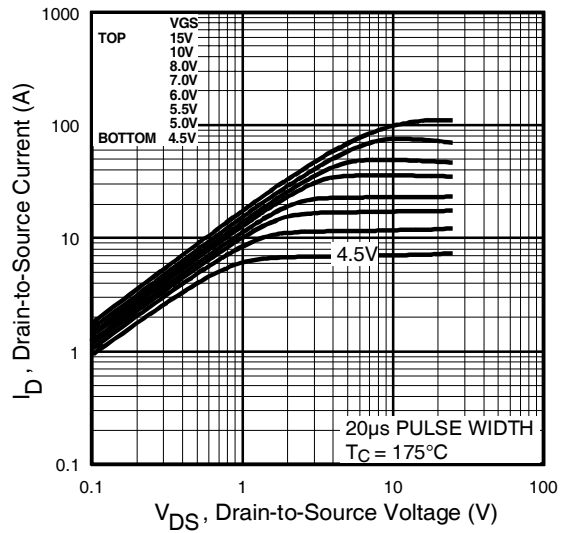
	Parameter	Min.	Typ.	Max.	Units	Conditions
$I_S$	Continuous Source Current (Body Diode)	—	—	29	A	MOSFET symbol showing the integral reverse p-n junction diode. 
$I_{SM}$	Pulsed Source Current (Body Diode) ①	—	—	100		
$V_{SD}$	Diode Forward Voltage	—	—	1.6	V	$T_J = 25^\circ\text{C}, I_S = 16A, V_{GS} = 0V$ ②
$t_{rr}$	Reverse Recovery Time	—	57	86	ns	$T_J = 25^\circ\text{C}, I_F = 16A$
$Q_{rr}$	Reverse Recovery Charge	—	130	200	nC	$di/dt = 100A/\mu s$ ③
$t_{on}$	Forward Turn-On Time	Intrinsic turn-on time is negligible (turn-on is dominated by $L_S + L_D$ )				

### Notes:

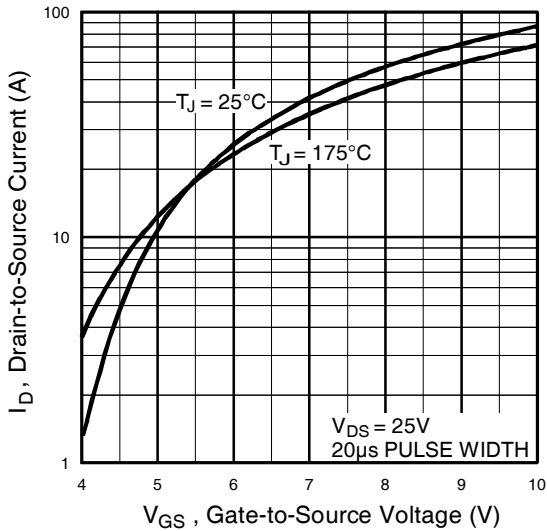
- ① Repetitive rating; pulse width limited by max. junction temperature. ( See fig. 11 )
- ②  $V_{DD} = 25V$ , starting  $T_J = 25^\circ\text{C}$ ,  $L = 410\mu H$   
 $R_G = 25\Omega, I_{AS} = 16A$ . (See Figure 12)
- ③  $I_{SD} \leq 16A, di/dt \leq 420A/\mu s, V_{DD} \leq V_{(BR)DSS}, T_J \leq 175^\circ\text{C}$
- ④ Pulse width  $\leq 300\mu s$ ; duty cycle  $\leq 2\%$ .



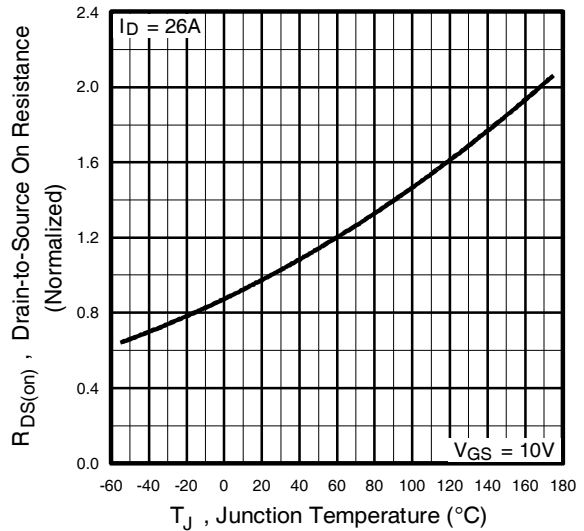
**Fig 1.** Typical Output Characteristics



**Fig 2.** Typical Output Characteristics

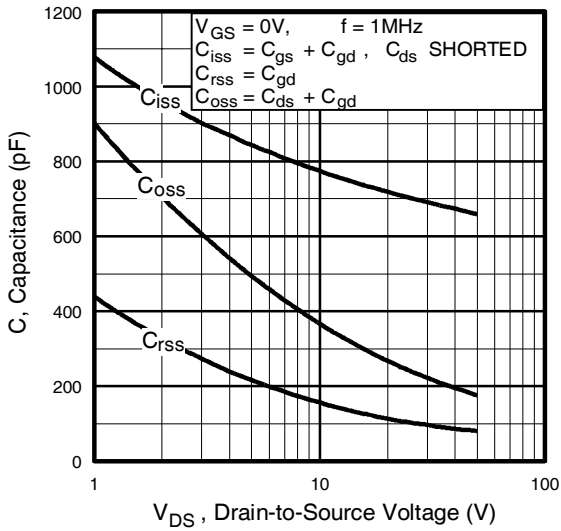


**Fig 3.** Typical Transfer Characteristics

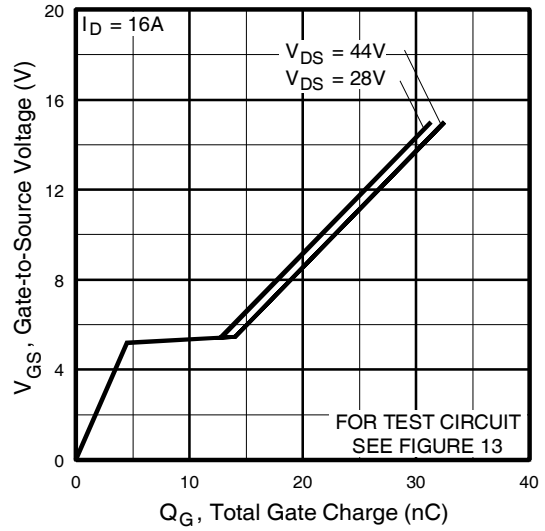


**Fig 4.** Normalized On-Resistance Vs. Temperature

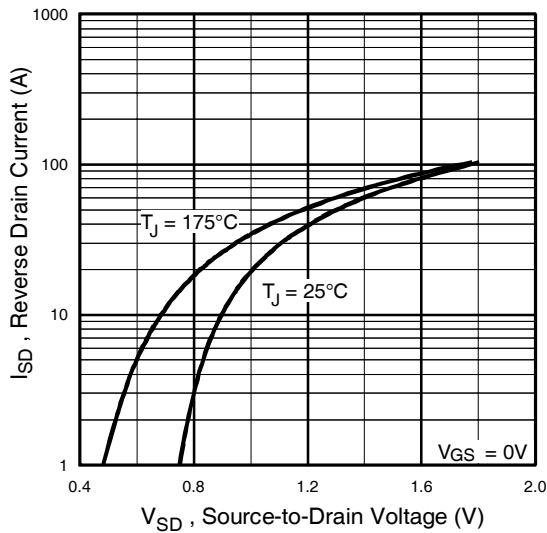
# IRFZ34NPbF



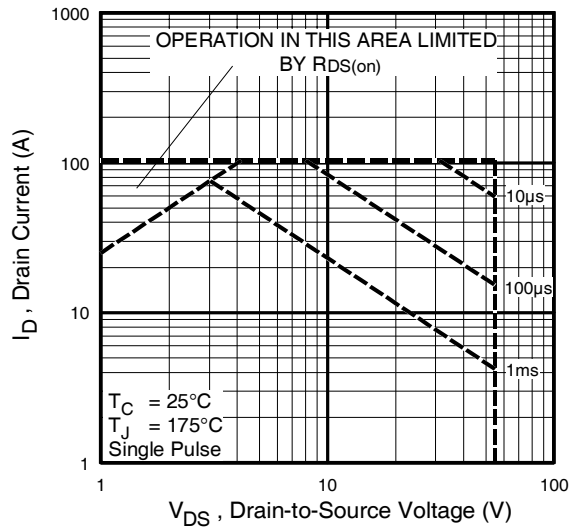
**Fig 5.** Typical Capacitance Vs. Drain-to-Source Voltage



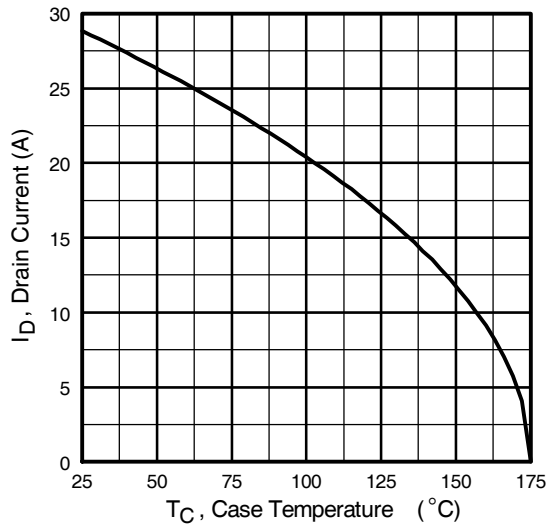
**Fig 6.** Typical Gate Charge Vs. Gate-to-Source Voltage



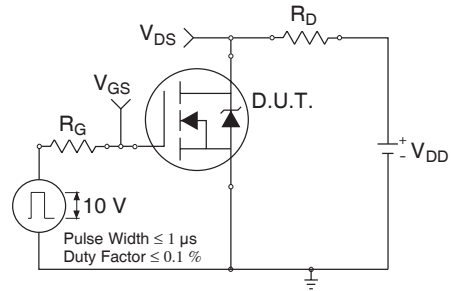
**Fig 7.** Typical Source-Drain Diode Forward Voltage



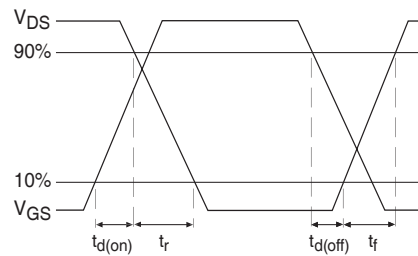
**Fig 8.** Maximum Safe Operating Area



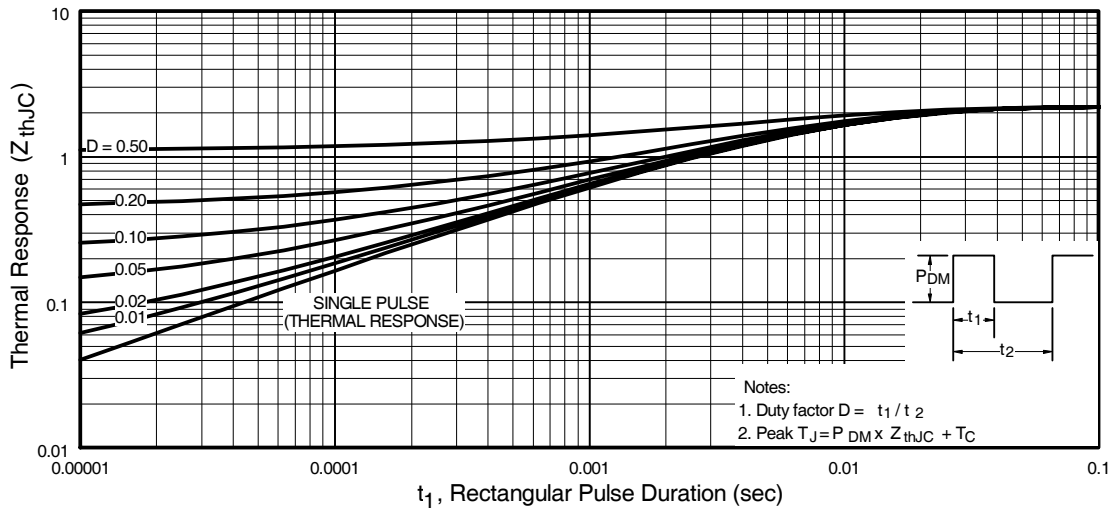
**Fig 9.** Maximum Drain Current Vs. Case Temperature



**Fig 10a.** Switching Time Test Circuit



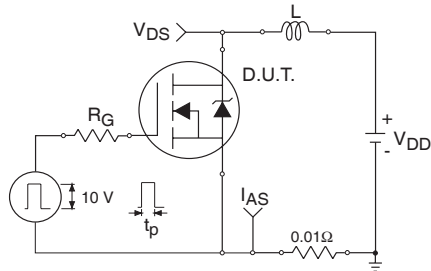
**Fig 10b.** Switching Time Waveforms



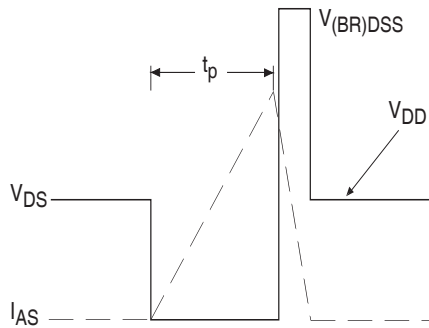
**Fig 11.** Maximum Effective Transient Thermal Impedance, Junction-to-Case

# IRFZ34NPbF

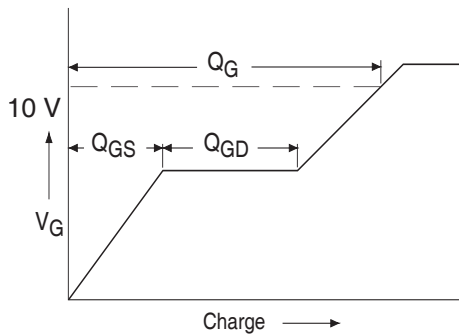
International  
**IR** Rectifier



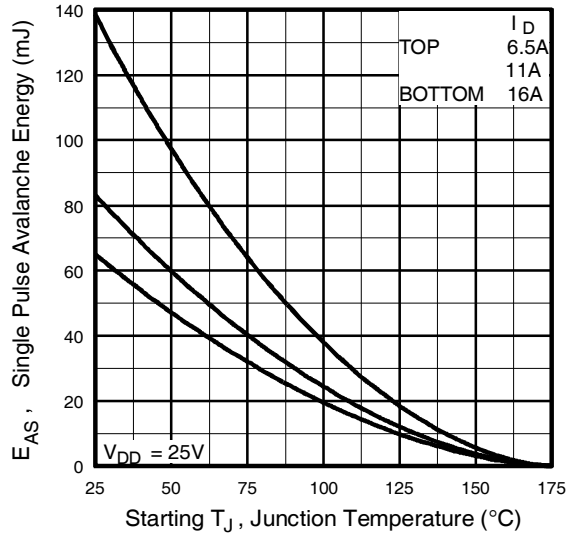
**Fig 12a.** Unclamped Inductive Test Circuit



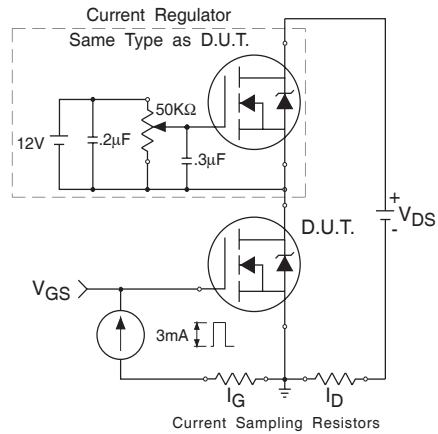
**Fig 12b.** Unclamped Inductive Waveforms



**Fig 13a.** Basic Gate Charge Waveform

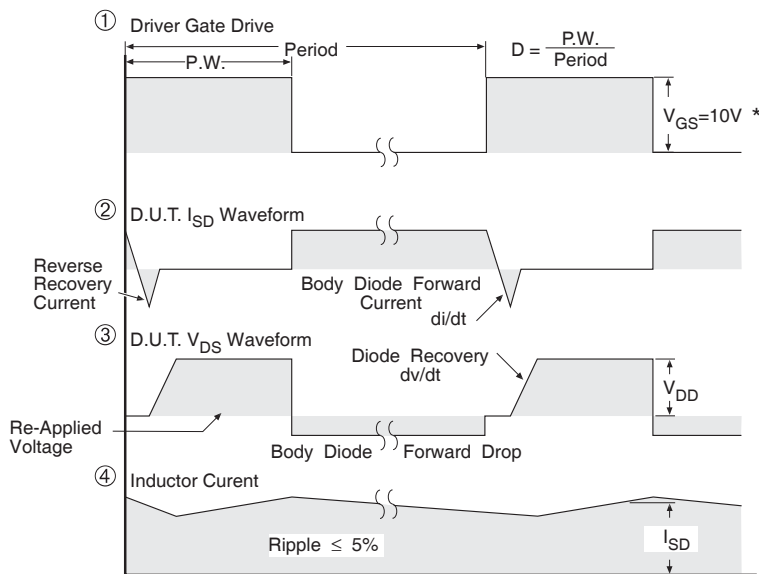
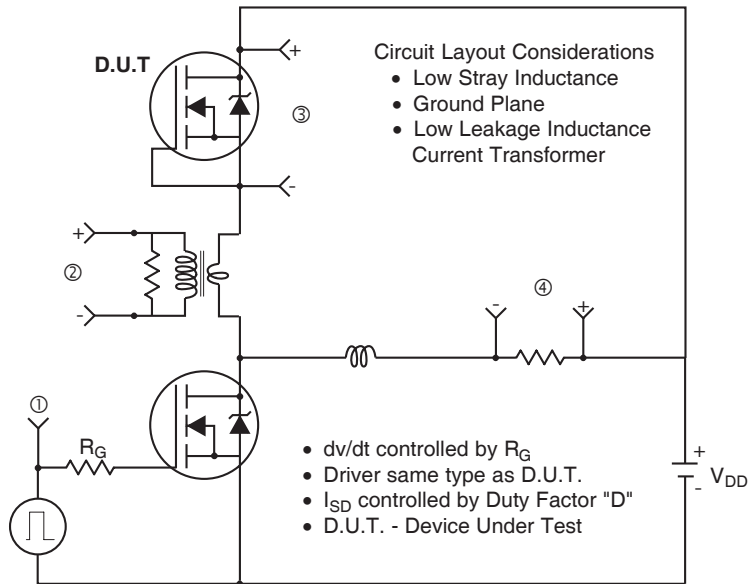


**Fig 12c.** Maximum Avalanche Energy Vs. Drain Current



**Fig 13b.** Gate Charge Test Circuit

## Peak Diode Recovery dv/dt Test Circuit



\*  $V_{GS} = 5V$  for Logic Level Devices

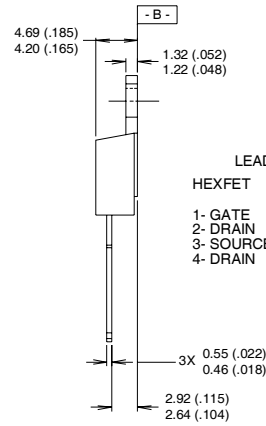
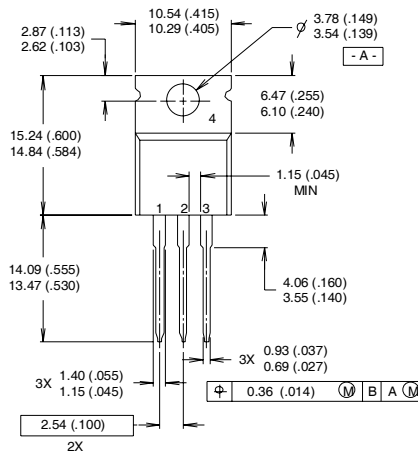
**Fig 14.** For N-Channel HEXFETS

# IRFZ34NPbF



## TO-220AB Package Outline

Dimensions are shown in millimeters (inches)



LEAD ASSIGNMENTS

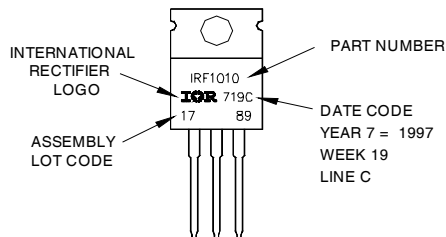
HEXFET	IGBTs, CoPACK
1- GATE	1- GATE
2- DRAIN	2- COLLECTOR
3- SOURCE	3- EMITTER
4- DRAIN	4- COLLECTOR

**NOTES:**

- 1 DIMENSIONING & TOLERANCING PER ANSI Y14.5M, 1982.
- 2 CONTROLLING DIMENSION : INCH
- 3 OUTLINE CONFORMS TO JEDEC OUTLINE TO-220AB.
- 4 HEATSINK & LEAD MEASUREMENTS DO NOT INCLUDE BURRS.

## TO-220AB Part Marking Information

EXAMPLE: THIS IS AN IRF1010  
 LOT CODE 1789  
 ASSEMBLED ON WW 19, 1997  
 IN THE ASSEMBLY LINE "C"  
**Note:** "P" in assembly line position indicates "Lead-Free"



Data and specifications subject to change without notice.



IR WORLD HEADQUARTERS: 233 Kansas St., El Segundo, California 90245, USA Tel: (310) 252-7105  
 TAC Fax: (310) 252-7903

Visit us at [www.irf.com](http://www.irf.com) for sales contact information.10/03

[www.irf.com](http://www.irf.com)



Note: For the most current drawings please refer to the IR website at:  
<http://www.irf.com/package/>

## **IMPORTANT NOTICE**

The information given in this document shall in no event be regarded as a guarantee of conditions or characteristics ("Beschaffheitsgarantie").

With respect to any examples, hints or any typical values stated herein and/or any information regarding the application of the product, Infineon Technologies hereby disclaims any and all warranties and liabilities of any kind, including without limitation warranties of non-infringement of intellectual property rights of any third party.

In addition, any information given in this document is subject to customer's compliance with its obligations stated in this document and any applicable legal requirements, norms and standards concerning customer's products and any use of the product of Infineon Technologies in customer's applications.

The data contained in this document is exclusively intended for technically trained staff. It is the responsibility of customer's technical departments to evaluate the suitability of the product for the intended application and the completeness of the product information given in this document with respect to such application.

For further information on the product, technology, delivery terms and conditions and prices please contact your nearest Infineon Technologies office ([www.infineon.com](http://www.infineon.com)).

## **WARNINGS**

Due to technical requirements products may contain dangerous substances. For information on the types in question please contact your nearest Infineon Technologies office.

Except as otherwise explicitly approved by Infineon Technologies in a written document signed by authorized representatives of Infineon Technologies, Infineon Technologies' products may not be used in any applications where a failure of the product or any consequences of the use thereof can reasonably be expected to result in personal injury.

# Mouser Electronics

Authorized Distributor

Click to View Pricing, Inventory, Delivery & Lifecycle Information:

[Infineon:](#)

[IRFZ34NPBF](#)