

Final datasheet

EconoDUAL™3 module with TRENCHSTOP™IGBT7 and emitter controlled 7 diode and NTC

Features

- Electrical features
 - $V_{CES} = 1200\text{ V}$
 - $I_{C\text{ nom}} = 900\text{ A} / I_{CRM} = 1800\text{ A}$
 - Integrated temperature sensor
 - TRENCHSTOP™ IGBT7
 - $V_{CE,sat}$ with positive temperature coefficient
 - Suitable Infineon gate drivers can be found under <https://www.infineon.com/gdfinder>
- Mechanical features
 - High power density
 - Isolated base plate
 - PressFIT contact technology
 - Standard housing
 - Direct-cooled base plate

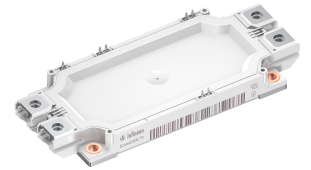

Potential applications

- High-power converters
- Motor drives
- Servo drives
- UPS systems
- Commercial agriculture vehicles

Product validation

- Qualified for industrial applications according to the relevant tests of IEC 60747, 60749 and 60068

Description

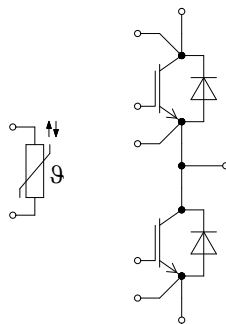

Table of contents

	Description	1
	Features	1
	Potential applications	1
	Product validation	1
	Table of contents	2
1	Package	3
2	IGBT, Inverter	4
3	Diode, Inverter	5
4	NTC-Thermistor	6
5	Characteristics diagrams	8
6	Circuit diagram	13
7	Package outlines	14
8	Module label code	15
	Revision history	16
	Disclaimer	17

1 Package

Table 1 Insulation coordination

Parameter	Symbol	Note or test condition	Values			Unit
			Min.	Typ.	Max.	
Isolation test voltage	V_{ISOL}	RMS, $f = 50$ Hz, $t = 60$ s	3.4			kV
Material of module baseplate			Cu			
Internal isolation		basic insulation (class 1, IEC 61140)	Al_2O_3			
Creepage distance	$d_{Creep\ nom}$	terminal to baseplate, nom., (PD2, IEC 60664-1, Ed. 3.0)	> 15			mm
Creepage distance	$d_{Creep\ min}$	terminal to baseplate, min., (PD2, IEC 60664-1, Ed. 3.0)	14.7			mm
Creepage distance	$d_{Creep\ nom}$	terminal to terminal, nom., (PD2, IEC 60664-1, Ed. 3.0)	12.1			mm
Creepage distance	$d_{Creep\ min}$	terminal to terminal, min., (PD2, IEC 60664-1, Ed. 3.0)	11.5			mm
Clearance	$d_{Clear\ nom}$	terminal to baseplate, nom.	> 12.5			mm
Clearance	$d_{Clear\ min}$	terminal to baseplate, min.	12.5			mm
Clearance	$d_{Clear\ nom}$	terminal to terminal, nom.	10.0			mm
Clearance	$d_{Clear\ min}$	terminal to terminal, min.	9.6			mm
Comparative tracking index	CTI		> 200			
Relative thermal index (electrical)	RTI	housing	140			°C

Table 2 Characteristic values

Parameter	Symbol	Note or test condition	Values			Unit
			Min.	Typ.	Max.	
Pressure drop in cooling circuit	Δp	$\Delta V/\Delta t = 10.0$ dm ³ /min, 50% water / 50% ethylen glycol, $T_F = 60$ °C		65		mbar
Maximum pressure in cooling circuit	p				3	bar
Stray inductance module	L_{SCE}			20		nH
Module lead resistance, terminals - chip	$R_{CC'+EE'}$	$T_F = 25$ °C, per switch		0.8		mΩ
Storage temperature	T_{stg}		-40		125	°C
Mounting torque for module mounting	M	- Mounting according to valid application note	M5, Screw	3	6	Nm
Terminal connection torque	M	- Mounting according to valid application note	M6, Screw	3	6	Nm
Weight	G			345		g

2 IGBT, Inverter

Table 3 Maximum rated values

Parameter	Symbol	Note or test condition	Values			Unit
			Min.	Typ.	Max.	
Collector-emitter voltage	V_{CES}	$T_{vj} = 25\text{ °C}$		1200		V
Continuous DC collector current	I_{CDC}	$T_{vj\ max} = 175\text{ °C}$ $T_F = 25\text{ °C}$		890		A
Maximum RMS module DC-terminal current	I_{tRMS}	$T_{Terminal} = 90\text{ °C}$, $T_C = 90\text{ °C}$		580		A
			$T_{Terminal} = 105\text{ °C}$, $T_C = 90\text{ °C}$		565	
Repetitive peak collector current	I_{CRM}	t_p limited by $T_{vj\ op}$		1800		A
Gate-emitter peak voltage	V_{GES}			±20		V

Table 4 Characteristic values

Parameter	Symbol	Note or test condition	Values			Unit	
			Min.	Typ.	Max.		
Collector-emitter saturation voltage	$V_{CE\ sat}$	$I_C = 900\text{ A}$, $V_{GE} = 15\text{ V}$	$T_{vj} = 25\text{ °C}$		1.50	1.80	V
			$T_{vj} = 125\text{ °C}$		1.65		
			$T_{vj} = 175\text{ °C}$		1.75		
Gate threshold voltage	V_{GEth}	$I_C = 18\text{ mA}$, $V_{CE} = V_{GE}$, $T_{vj} = 25\text{ °C}$	5.15	5.80	6.45	V	
Gate charge	Q_G	$V_{GE} = \pm 15\text{ V}$, $V_{CC} = 600\text{ V}$		14.3		μC	
Internal gate resistor	R_{Gint}	$T_{vj} = 25\text{ °C}$		0.5		Ω	
Input capacitance	C_{ies}	$f = 100\text{ kHz}$, $T_{vj} = 25\text{ °C}$, $V_{CE} = 25\text{ V}$, $V_{GE} = 0\text{ V}$		122		nF	
Reverse transfer capacitance	C_{res}	$f = 100\text{ kHz}$, $T_{vj} = 25\text{ °C}$, $V_{CE} = 25\text{ V}$, $V_{GE} = 0\text{ V}$		0.72		nF	
Collector-emitter cut-off current	I_{CES}	$V_{CE} = 1200\text{ V}$, $V_{GE} = 0\text{ V}$ $T_{vj} = 25\text{ °C}$			0.1	mA	
Gate-emitter leakage current	I_{GES}	$V_{CE} = 0\text{ V}$, $V_{GE} = 20\text{ V}$, $T_{vj} = 25\text{ °C}$			100	nA	
Turn-on delay time (inductive load)	t_{don}	$I_C = 900\text{ A}$, $V_{CC} = 600\text{ V}$, $V_{GE} = \pm 15\text{ V}$, $R_{Gon} = 0.51\text{ Ω}$	$T_{vj} = 25\text{ °C}$		0.410		μs
			$T_{vj} = 125\text{ °C}$		0.460		
			$T_{vj} = 175\text{ °C}$		0.490		
Rise time (inductive load)	t_r	$I_C = 900\text{ A}$, $V_{CC} = 600\text{ V}$, $V_{GE} = \pm 15\text{ V}$, $R_{Gon} = 0.51\text{ Ω}$	$T_{vj} = 25\text{ °C}$		0.100		μs
			$T_{vj} = 125\text{ °C}$		0.110		
			$T_{vj} = 175\text{ °C}$		0.120		

(table continues...)

Table 4 (continued) Characteristic values

Parameter	Symbol	Note or test condition	Values			Unit
			Min.	Typ.	Max.	
Turn-off delay time (inductive load)	t_{doff}	$I_C = 900\text{ A}, V_{CC} = 600\text{ V}, V_{GE} = \pm 15\text{ V}, R_{Goff} = 0.51\ \Omega$	$T_{vj} = 25\text{ }^\circ\text{C}$	0.550		μs
			$T_{vj} = 125\text{ }^\circ\text{C}$	0.630		
			$T_{vj} = 175\text{ }^\circ\text{C}$	0.690		
Fall time (inductive load)	t_f	$I_C = 900\text{ A}, V_{CC} = 600\text{ V}, V_{GE} = \pm 15\text{ V}, R_{Goff} = 0.51\ \Omega$	$T_{vj} = 25\text{ }^\circ\text{C}$	0.110		μs
			$T_{vj} = 125\text{ }^\circ\text{C}$	0.230		
			$T_{vj} = 175\text{ }^\circ\text{C}$	0.330		
Turn-on energy loss per pulse	E_{on}	$I_C = 900\text{ A}, V_{CC} = 600\text{ V}, L_\sigma = 25\text{ nH}, V_{GE} = \pm 15\text{ V}, R_{Gon} = 0.51\ \Omega, di/dt = 6200\text{ A}/\mu\text{s} (T_{vj} = 175\text{ }^\circ\text{C})$	$T_{vj} = 25\text{ }^\circ\text{C}$	89		mJ
			$T_{vj} = 125\text{ }^\circ\text{C}$	138		
			$T_{vj} = 175\text{ }^\circ\text{C}$	170		
Turn-off energy loss per pulse	E_{off}	$I_C = 900\text{ A}, V_{CC} = 600\text{ V}, L_\sigma = 25\text{ nH}, V_{GE} = \pm 15\text{ V}, R_{Goff} = 0.51\ \Omega, dv/dt = 3000\text{ V}/\mu\text{s} (T_{vj} = 175\text{ }^\circ\text{C})$	$T_{vj} = 25\text{ }^\circ\text{C}$	89		mJ
			$T_{vj} = 125\text{ }^\circ\text{C}$	130		
			$T_{vj} = 175\text{ }^\circ\text{C}$	158		
SC data	I_{SC}	$V_{GE} \leq 15\text{ V}, V_{CC} = 800\text{ V}, V_{CEmax} = V_{CES} - L_{SCE} * di/dt$	$t_p \leq 8\ \mu\text{s}, T_{vj} = 150\text{ }^\circ\text{C}$	3200		A
			$t_p \leq 6\ \mu\text{s}, T_{vj} = 175\text{ }^\circ\text{C}$	3000		
Thermal resistance, junction to cooling fluid ¹⁾	R_{thJF}	per IGBT, $\Delta V/\Delta t = 10.0\text{ dm}^3/\text{min}$, 50% water / 50% ethylenglycol, $T_F = 60\text{ }^\circ\text{C}$		0.0837		K/W
Temperature under switching conditions	$T_{vj\ op}$		-40		175	$^\circ\text{C}$

1) Typical R_{thJF} value using the heat sink described in AN-2022-05

Note: $T_{vj\ op} > 150\text{ }^\circ\text{C}$ is only allowed for operation at overload conditions. For detailed specifications please refer to AN 2018-14.

3 Diode, Inverter

Table 5 Maximum rated values

Parameter	Symbol	Note or test condition	Values	Unit
Repetitive peak reverse voltage	V_{RRM}	$T_{vj} = 25\text{ }^\circ\text{C}$	1200	V
Continuous DC forward current	I_F		900	A
Repetitive peak forward current	I_{FRM}	$t_p = 1\text{ ms}$	1800	A

(table continues...)

Table 5 (continued) Maximum rated values

Parameter	Symbol	Note or test condition	Values			Unit
			Min.	Typ.	Max.	
I ² t - value	I ² t	t _p = 10 ms, V _R = 0 V	T _{vj} = 125 °C	35000		A ² s
			T _{vj} = 175 °C	30000		

Table 6 Characteristic values

Parameter	Symbol	Note or test condition	Values			Unit	
			Min.	Typ.	Max.		
Forward voltage	V _F	I _F = 900 A, V _{GE} = 0 V	T _{vj} = 25 °C		1.80	2.05	V
			T _{vj} = 125 °C		1.70		
			T _{vj} = 175 °C		1.65		
Peak reverse recovery current	I _{RM}	V _{CC} = 600 V, I _F = 900 A, V _{GE} = -15 V, -di _F /dt = 6200 A/μs (T _{vj} = 175 °C)	T _{vj} = 25 °C		389		A
			T _{vj} = 125 °C		511		
			T _{vj} = 175 °C		578		
Recovered charge	Q _r	V _{CC} = 600 V, I _F = 900 A, V _{GE} = -15 V, -di _F /dt = 6200 A/μs (T _{vj} = 175 °C)	T _{vj} = 25 °C		65		μC
			T _{vj} = 125 °C		127		
			T _{vj} = 175 °C		171		
Reverse recovery energy	E _{rec}	V _{CC} = 600 V, I _F = 900 A, V _{GE} = -15 V, -di _F /dt = 6200 A/μs (T _{vj} = 175 °C)	T _{vj} = 25 °C		29		mJ
			T _{vj} = 125 °C		52		
			T _{vj} = 175 °C		68		
Thermal resistance, junction to cooling fluid ¹⁾	R _{thJF}	per diode, ΔV/Δt = 10.0 dm ³ /min, cooling fluid = 50% water / 50% ethylenglycol, T _F = 60 °C		0.132		K/W	
Temperature under switching conditions	T _{vj op}		-40		175	°C	

1) Typical R_{thJF} value using the heat sink described in AN-2022-05

Note: T_{vj op} > 150 °C is only allowed for operation at overload conditions. For detailed specifications please refer to AN 2018-14.

4 NTC-Thermistor

Table 7 Characteristic values

Parameter	Symbol	Note or test condition	Values			Unit
			Min.	Typ.	Max.	
Rated resistance	R ₂₅	T _{NTC} = 25 °C		5		kΩ
Deviation of R ₁₀₀	ΔR/R	T _{NTC} = 100 °C, R ₁₀₀ = 493 Ω	-5		5	%
Power dissipation	P ₂₅	T _{NTC} = 25 °C			20	mW

(table continues...)

Table 7 (continued) **Characteristic values**

Parameter	Symbol	Note or test condition	Values			Unit
			Min.	Typ.	Max.	
B-value	$B_{25/50}$	$R_2 = R_{25} \exp[B_{25/50}(1/T_2 - 1/(298,15 \text{ K}))]$		3375		K
B-value	$B_{25/80}$	$R_2 = R_{25} \exp[B_{25/80}(1/T_2 - 1/(298,15 \text{ K}))]$		3411		K
B-value	$B_{25/100}$	$R_2 = R_{25} \exp[B_{25/100}(1/T_2 - 1/(298,15 \text{ K}))]$		3433		K

Note: For an analytical description of the NTC characteristics please refer to AN2009-10, chapter 4

5 Characteristics diagrams

Output characteristic (typical), IGBT, Inverter

$I_C = f(V_{CE})$
 $V_{GE} = 15 \text{ V}$

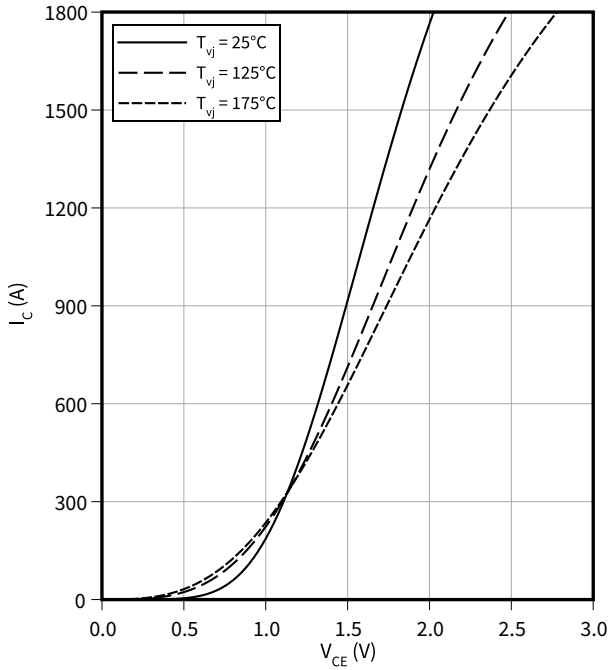

Output characteristic field (typical), IGBT, Inverter

$I_C = f(V_{CE})$
 $T_{vj} = 175 \text{ °C}$

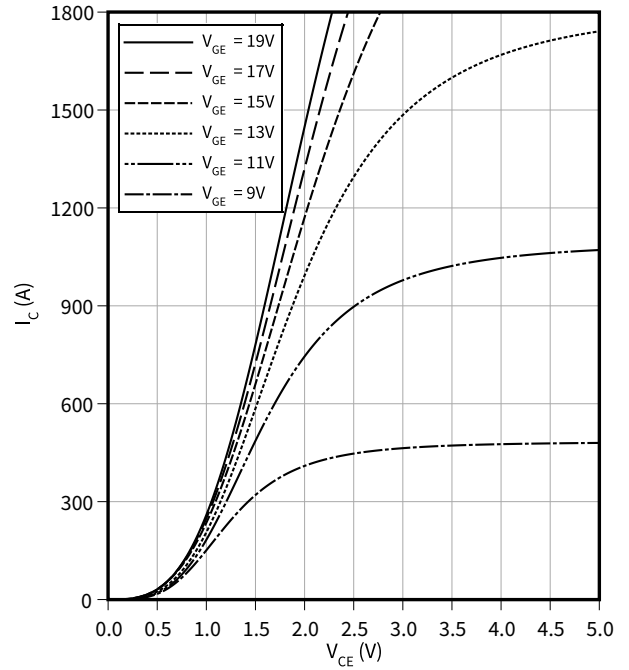

Transfer characteristic (typical), IGBT, Inverter

$I_C = f(V_{GE})$
 $V_{CE} = 20 \text{ V}$

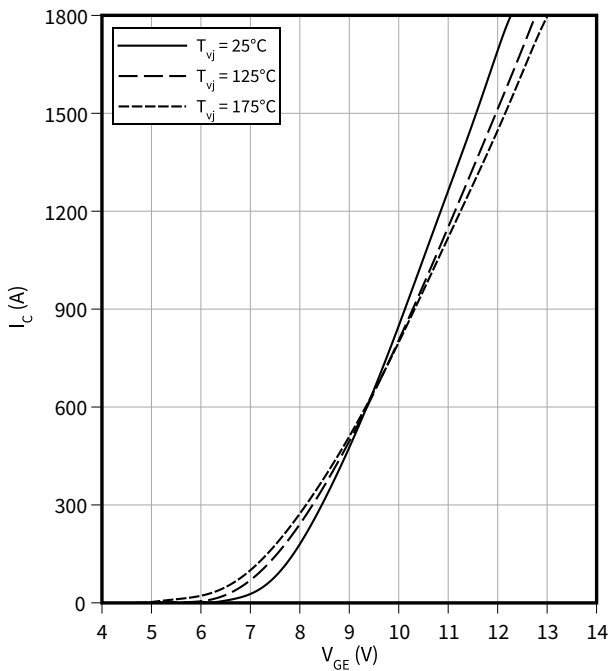

Gate charge characteristic (typical), IGBT, Inverter

$V_{GE} = f(Q_G)$
 $I_C = 900 \text{ A}, T_{vj} = 25 \text{ °C}$

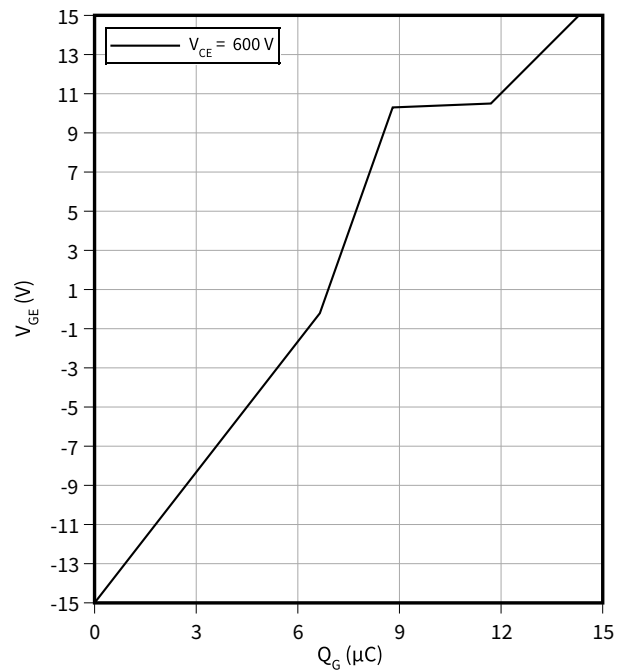

5 Characteristics diagrams

Capacity characteristic (typical), IGBT, Inverter

$C = f(V_{CE})$

$f = 100 \text{ kHz}, V_{GE} = 0 \text{ V}, T_{vj} = 25 \text{ }^\circ\text{C}$

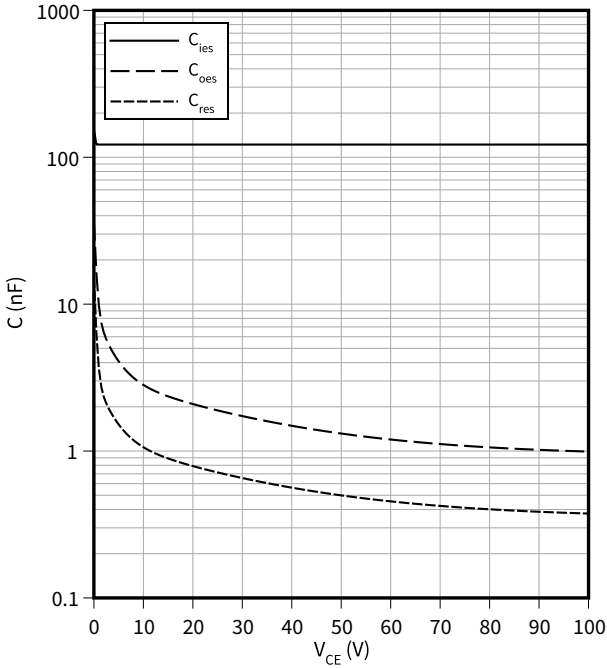

Switching times (typical), IGBT, Inverter

$t = f(I_C)$

$R_{Goff} = 0.51 \text{ } \Omega, R_{Gon} = 0.51 \text{ } \Omega, V_{CC} = 600 \text{ V}, V_{GE} = \pm 15 \text{ V}, T_{vj} = 175 \text{ }^\circ\text{C}$

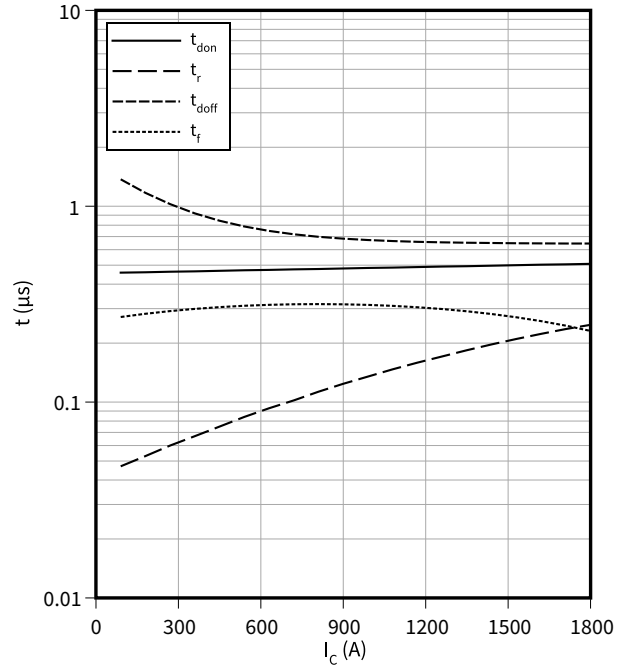

Switching times (typical), IGBT, Inverter

$t = f(R_G)$

$I_C = 900 \text{ A}, V_{CC} = 600 \text{ V}, V_{GE} = \pm 15 \text{ V}$

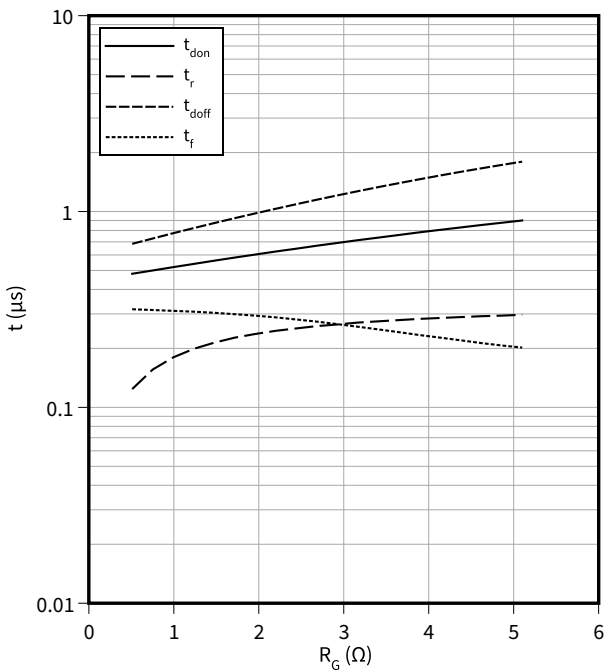

Voltage slope (typical), IGBT, Inverter

$dv/dt = f(R_G)$

$I_C = 900 \text{ A}, V_{CE} = 600 \text{ V}, V_{GE} = \pm 15 \text{ V}, T_{vj} = 25 \text{ }^\circ\text{C}$

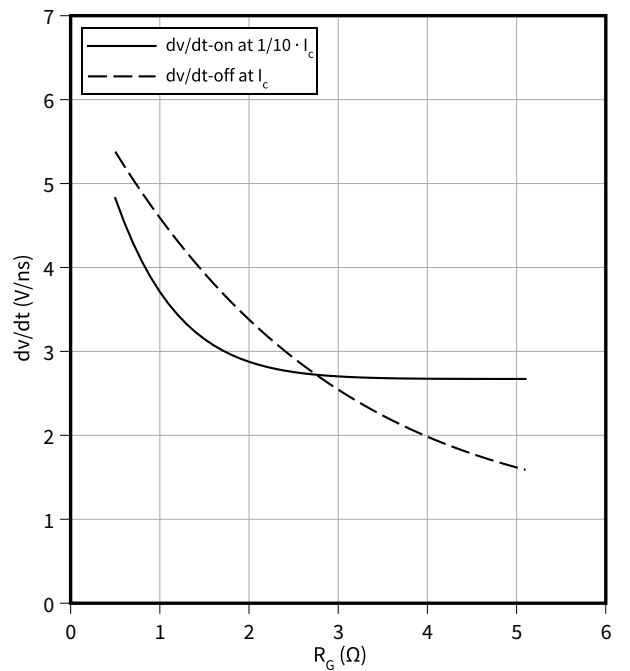

5 Characteristics diagrams

Switching losses (typical), IGBT, Inverter

$E = f(I_C)$

$R_{Goff} = 0.51 \Omega$, $R_{Gon} = 0.51 \Omega$, $V_{CC} = 600 \text{ V}$, $V_{GE} = \pm 15 \text{ V}$

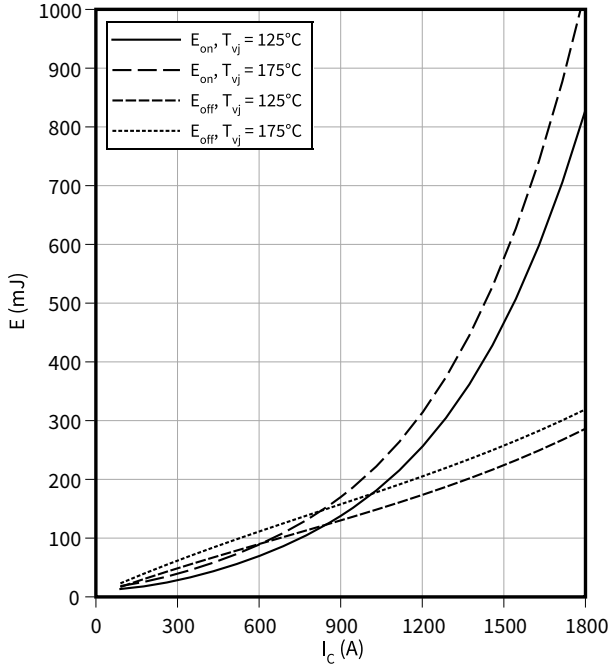

Switching losses (typical), IGBT, Inverter

$E = f(R_G)$

$I_C = 900 \text{ A}$, $V_{CC} = 600 \text{ V}$, $V_{GE} = \pm 15 \text{ V}$

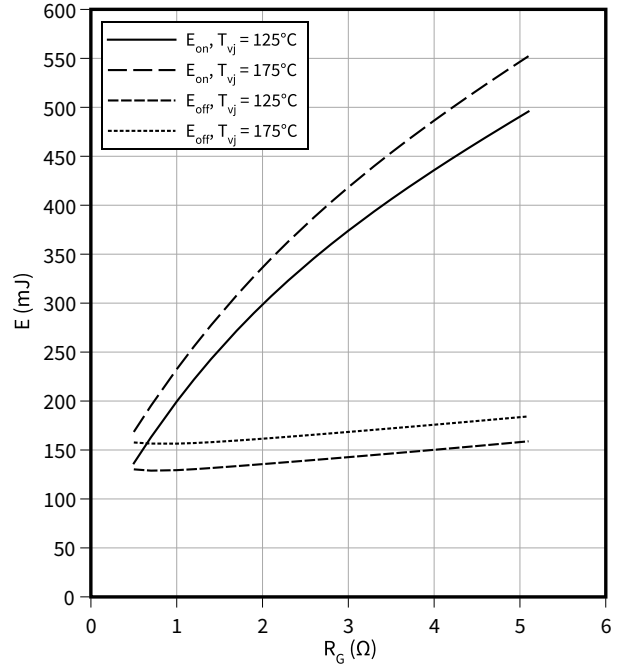

Reverse bias safe operating area (RBSOA), IGBT, Inverter

$I_C = f(V_{CE})$

$R_{Goff} = 0.51 \Omega$, $V_{GE} = \pm 15 \text{ V}$, $T_{vj} = 175 \text{ °C}$

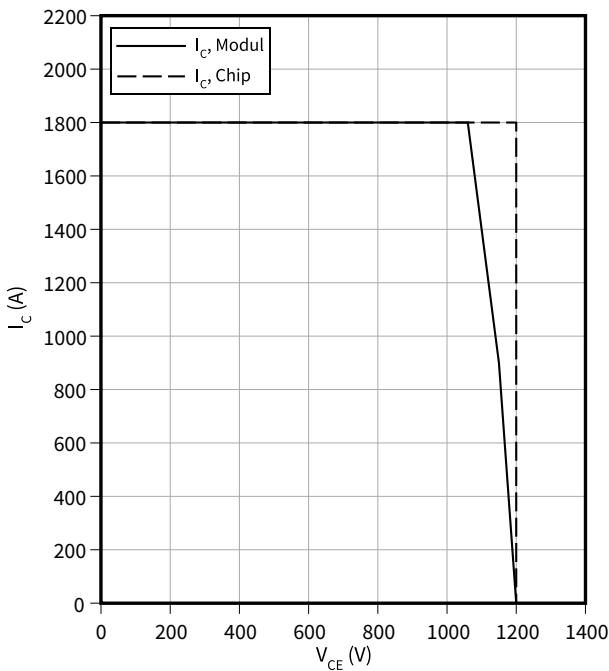

Transient thermal impedance, IGBT, Inverter

$Z_{th} = f(t)$

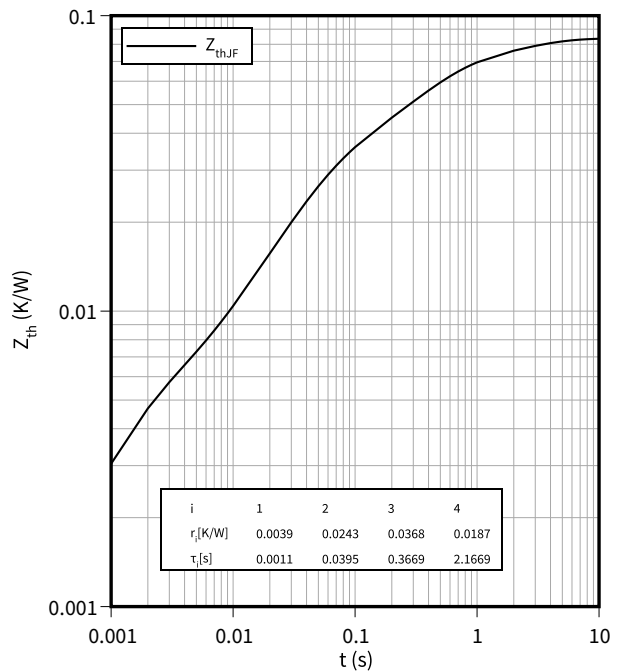

5 Characteristics diagrams

Thermal impedance, IGBT, Inverter

$R_{thJF} = f(\Delta V/\Delta t)$

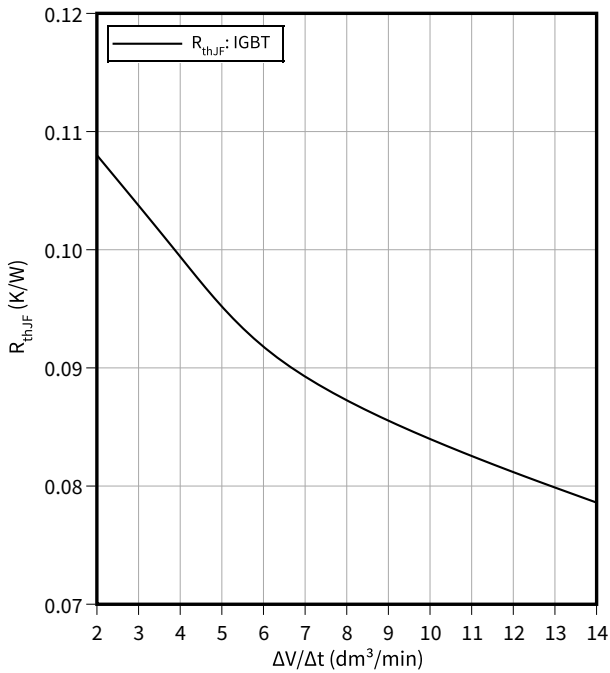

Forward characteristic (typical), Diode, Inverter

$I_F = f(V_F)$

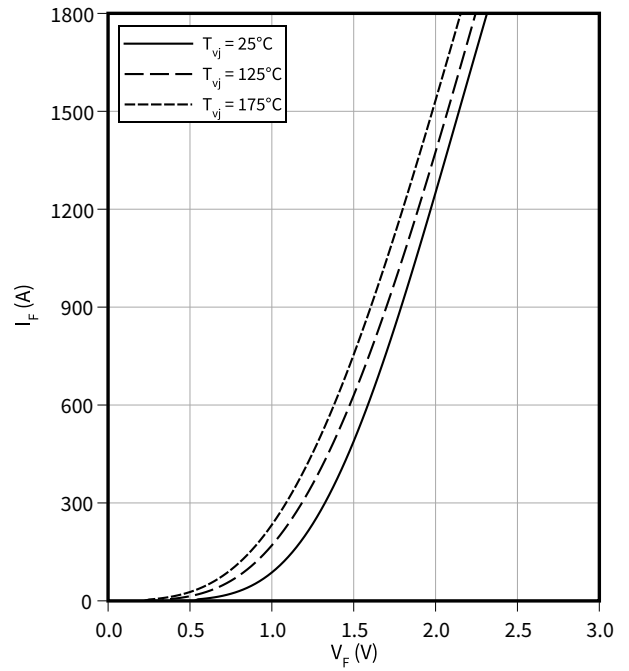

Switching losses (typical), Diode, Inverter

$E_{rec} = f(I_F)$

$R_{Gon} = 0.51 \Omega, V_{CE} = 600 V$

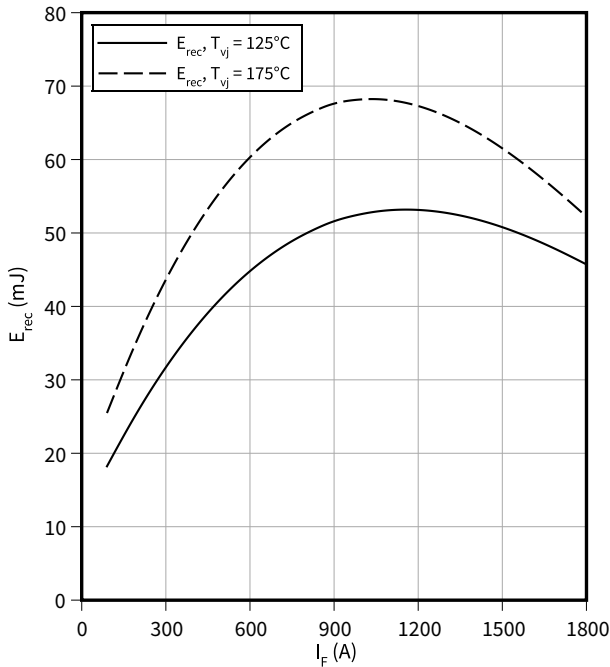

Switching losses (typical), Diode, Inverter

$E_{rec} = f(R_G)$

$V_{CE} = 600 V, I_F = 900 A$

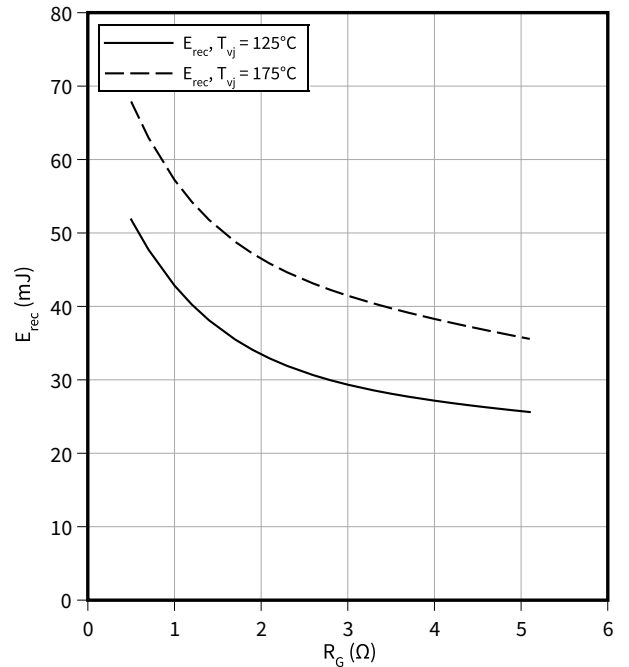

5 Characteristics diagrams

Transient thermal impedance, Diode, Inverter

$Z_{th} = f(t)$

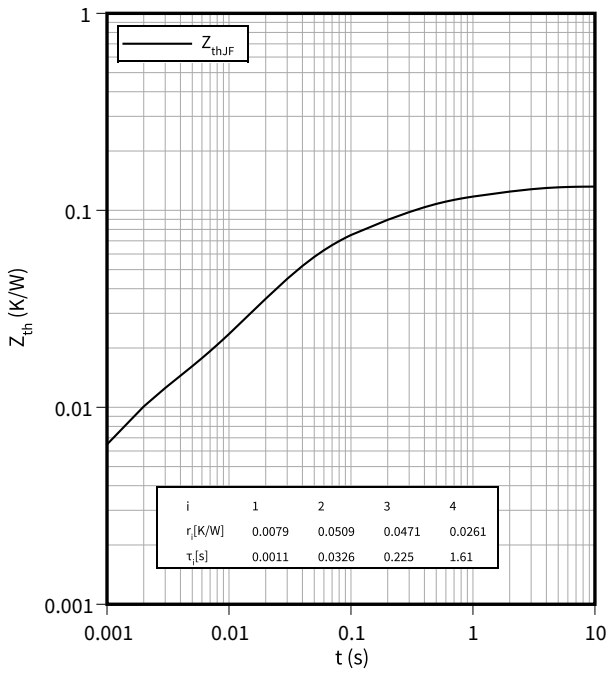

Thermal impedance, Diode, Inverter

$R_{thJF} = f(\Delta V/\Delta t)$

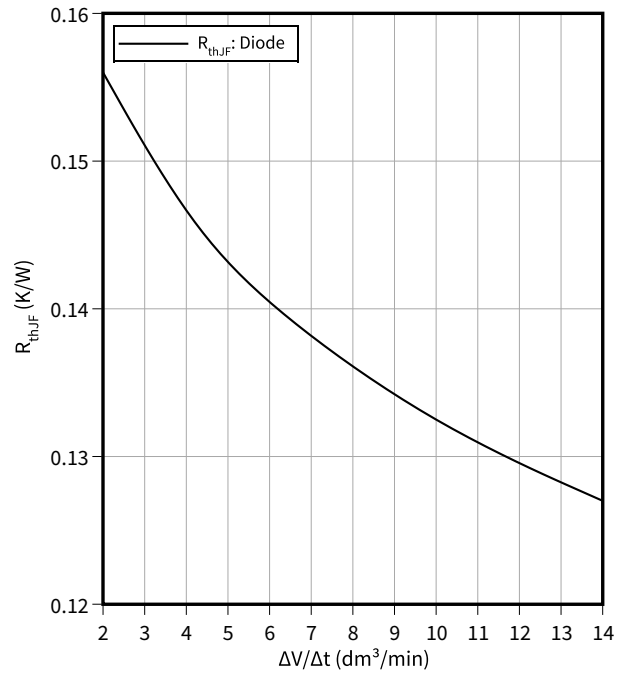

Temperature characteristic (typical), NTC-Thermistor

$R = f(T_{NTC})$

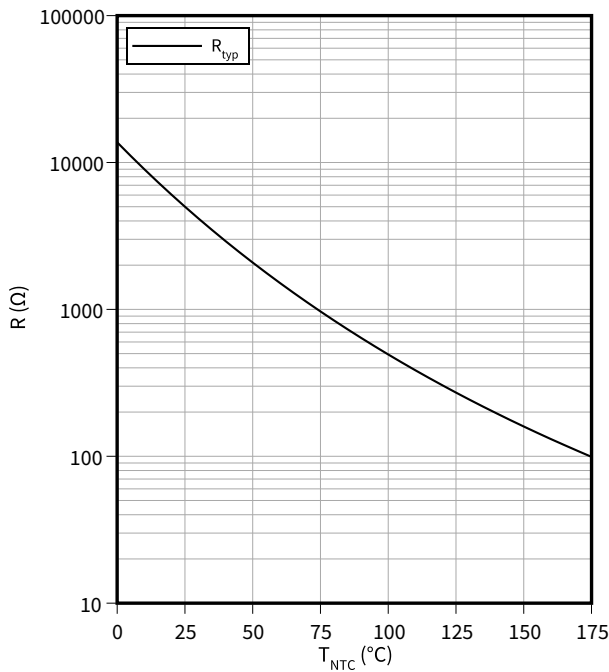

6 Circuit diagram

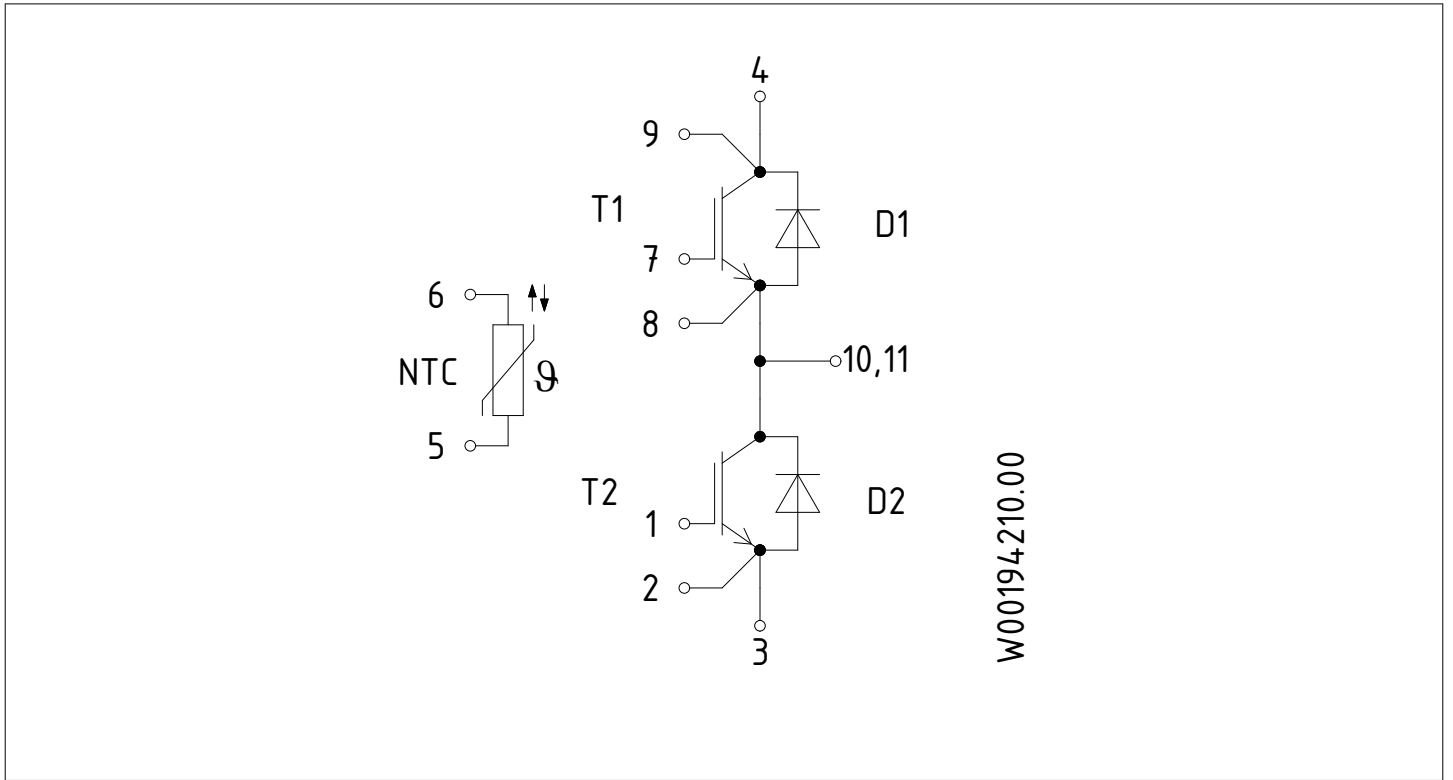

Figure 1

7 Package outlines

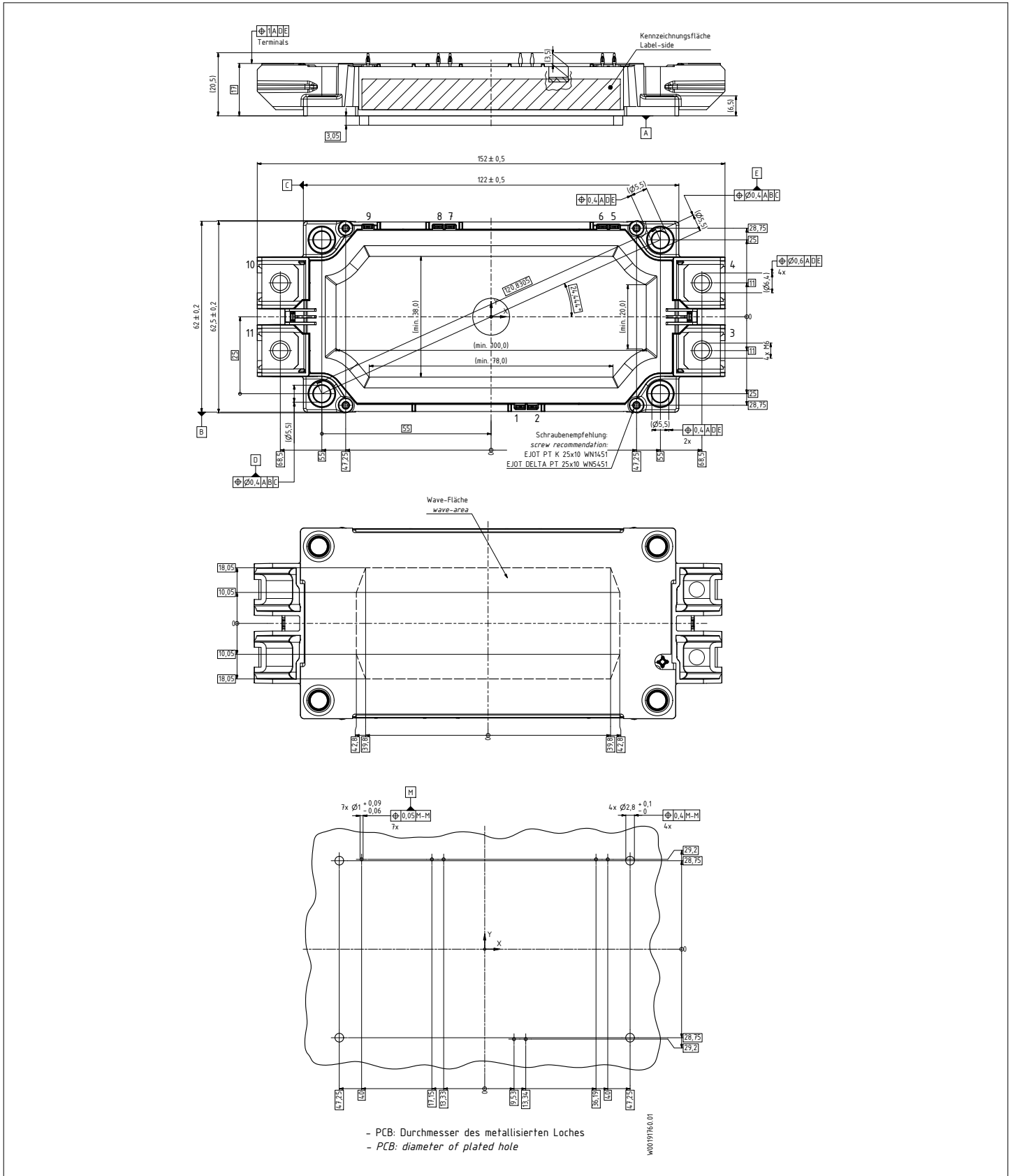

Figure 2

8 Module label code

Module label code			
Code format	Data Matrix	Barcode Code128	
Encoding	ASCII text	Code Set A	
Symbol size	16x16	23 digits	
Standard	IEC24720 and IEC16022	IEC8859-1	
Code content	Content	Digit	Example
	Module serial number	1 - 5	71549
	Module material number	6 - 11	142846
	Production order number	12 - 19	55054991
	Date code (production year)	20 - 21	15
	Date code (production week)	22 - 23	30
Example	 		
	71549142846550549911530		71549142846550549911530

Figure 3

Revision history

Document revision	Date of release	Description of changes
V1.0	2020-06-09	Target datasheet
n/a	2020-09-01	Datasheet migrated to a new system with a new layout and new revision number schema: target or preliminary datasheet = 0.xy; final datasheet = 1.xy
0.10	2021-07-08	Target datasheet
1.00	2022-04-01	Final datasheet
1.10	2024-03-13	Corrected axis label of diagram: Thermal impedance, Diode, Inverter

Trademarks

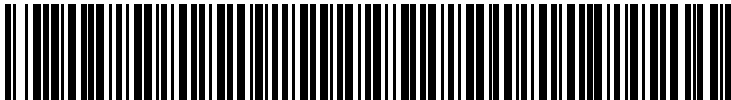
All referenced product or service names and trademarks are the property of their respective owners.

Edition 2024-03-13

Published by

Infineon Technologies AG

81726 Munich, Germany

© 2024 Infineon Technologies AG

All Rights Reserved.

Do you have a question about any aspect of this document?

Email: erratum@infineon.com

Document reference

IFX-AAJ663-004

Important notice

The information given in this document shall in no event be regarded as a guarantee of conditions or characteristics ("Beschaffheitsgarantie").

With respect to any examples, hints or any typical values stated herein and/or any information regarding the application of the product, Infineon Technologies hereby disclaims any and all warranties and liabilities of any kind, including without limitation warranties of non-infringement of intellectual property rights of any third party.

In addition, any information given in this document is subject to customer's compliance with its obligations stated in this document and any applicable legal requirements, norms and standards concerning customer's products and any use of the product of Infineon Technologies in customer's applications.

The data contained in this document is exclusively intended for technically trained staff. It is the responsibility of customer's technical departments to evaluate the suitability of the product for the intended application and the completeness of the product information given in this document with respect to such application.

Warnings

Due to technical requirements products may contain dangerous substances. For information on the types in question please contact your nearest Infineon Technologies office.

Except as otherwise explicitly approved by Infineon Technologies in a written document signed by authorized representatives of Infineon Technologies, Infineon Technologies' products may not be used in any applications where a failure of the product or any consequences of the use thereof can reasonably be expected to result in personal injury.

Mouser Electronics

Authorized Distributor

Click to View Pricing, Inventory, Delivery & Lifecycle Information:

[Infineon:](#)

[FF900R12ME7WBPSA1](#)