

Silicon PIN Diode

- Series diode for mobile communication in low loss transmit-receiver switches
- Band switch for TV-tuners
- Very low forward resistance (typ. 0.65 Ω @ 5 mA)
- Low capacitance (typ. 0.5 pF @ 0V)
- Fast switching applications
- Pb-free (RoHS compliant) package

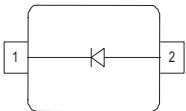

BAR65-02L
BAR65-02V
BAR65-03W



| Type | Package | Configuration | L_S (nH) | Marking |
|------------|----------|------------------|------------|---------|
| BAR65-02L* | TSLP-2-1 | single, leadless | 0.4 | NN |
| BAR65-02V | SC79 | single | 0.6 | N |
| BAR65-03W | SOD323 | single | 1.8 | blue M |

* Preliminary Data

Maximum Ratings at $T_A = 25^\circ\text{C}$, unless otherwise specified

| Parameter | Symbol | Value | Unit |
|---|-----------|-------------|------------------|
| Diode reverse voltage | V_R | 30 | V |
| Forward current | I_F | 100 | mA |
| Total power dissipation | P_{tot} | | mW |
| BAR65-02L, $T_S \leq 128^\circ\text{C}$ | | 250 | |
| BAR65-02V, $T_S \leq 118^\circ\text{C}$ | | 250 | |
| BAR65-03W, $T_S \leq 113^\circ\text{C}$ | | 250 | |
| Junction temperature | T_j | 150 | $^\circ\text{C}$ |
| Operating temperature range | T_{op} | -55 ... 125 | |
| Storage temperature | T_{stg} | -55 ... 150 | |

Thermal Resistance

| Parameter | Symbol | Value | Unit |
|--|------------|-------|------|
| Junction - soldering point ¹⁾ | R_{thJS} | | K/W |
| BAR65-02L | | ≤ 90 | |
| BAR65-02V | | ≤ 130 | |
| BAR65-03W | | ≤ 145 | |

Electrical Characteristics at $T_A = 25^\circ\text{C}$, unless otherwise specified

| Parameter | Symbol | Values | | | Unit |
|-----------|--------|--------|------|------|------|
| | | min. | typ. | max. | |

DC Characteristics

| | | | | | |
|--|-------|---|------|----|----|
| Reverse current $V_R = 20\text{ V}$ | I_R | - | - | 20 | nA |
| Forward voltage $I_F = 100\text{ mA}$ | V_F | - | 0.93 | 1 | V |

¹⁾For calculation of R_{thJA} please refer to Application Note Thermal Resistance

Electrical Characteristics at $T_A = 25^\circ\text{C}$, unless otherwise specified

| Parameter | Symbol | Values | | | Unit |
|--|-------------|-------------|----------------------|------------------|---------------|
| | | min. | typ. | max. | |
| AC Characteristics | | | | | |
| Diode capacitance $V_R = 1\text{ V}, f = 1\text{ MHz}$ $V_R = 3\text{ V}, f = 1\text{ MHz}$ $V_R = 0\text{ V}, f = 100\text{ MHz} \dots 1.8\text{ GHz}$ | C_T | - - - | 0.45 0.4 0.5 | 0.9 0.8 - | pF |
| Reverse parallel resistance $V_R = 0\text{ V}, f = 100\text{ MHz}$ $V_R = 0\text{ V}, f = 1\text{ GHz}$ $V_R = 0\text{ V}, f = 1.8\text{ GHz}$ | R_P | - - - | 700 10 5 | - - - | k Ω |
| Forward resistance $I_F = 1\text{ mA}, f = 100\text{ MHz}$ $I_F = 5\text{ mA}, f = 100\text{ MHz}$ $I_F = 10\text{ mA}, f = 100\text{ MHz}$ | r_f | - - - | 1 0.65 0.56 | - 0.95 0.9 | Ω |
| Charge carrier life time $I_F = 10\text{ mA}, I_R = 6\text{ mA}$, measured at $I_R = 3\text{ mA}$, $R_L = 100\ \Omega$ | τ_{rr} | - | 80 | - | ns |
| I-region width | W_I | - | 3.5 | - | μm |
| Insertion loss ¹⁾ $I_F = 1\text{ mA}, f = 1.8\text{ GHz}$ $I_F = 5\text{ mA}, f = 1.8\text{ GHz}$ $I_F = 10\text{ mA}, f = 1.8\text{ GHz}$ | I_L | - - - | 0.08 0.06 0.05 | - - - | dB |
| Isolation ¹⁾ $V_R = 0\text{ V}, f = 0.9\text{ GHz}$ $V_R = 0\text{ V}, f = 1.8\text{ GHz}$ $V_R = 0\text{ V}, f = 2.45\text{ GHz}$ | I_{SO} | - - - | 12 7 5 | - - - | |

¹BAR65-02L in series configuration, $Z = 50\ \Omega$

Diode capacitance $C_T = f(V_R)$

$f = \text{Parameter}$

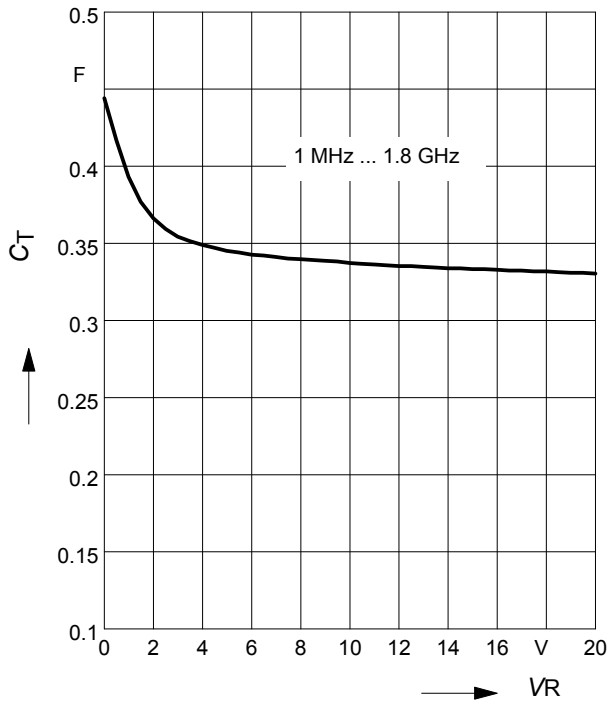

Reverse parallel resistance $R_P = f(V_R)$

$f = \text{Parameter}$

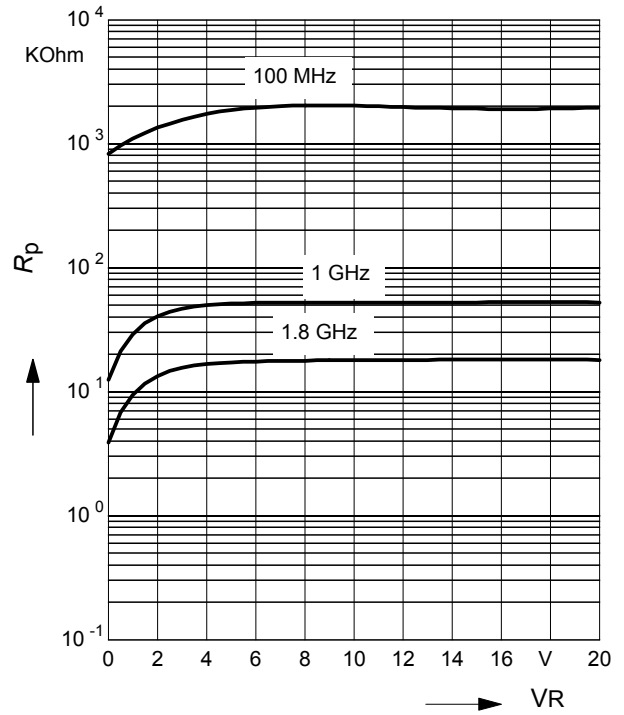

Forward resistance $r_f = f(I_F)$

$f = 100\text{MHz}$

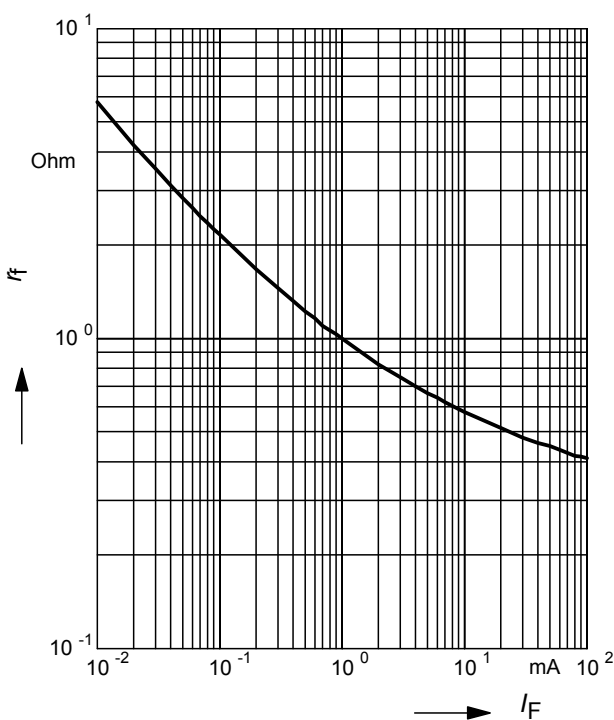

Forward current $I_F = f(V_F)$

$T_A = \text{Parameter}$

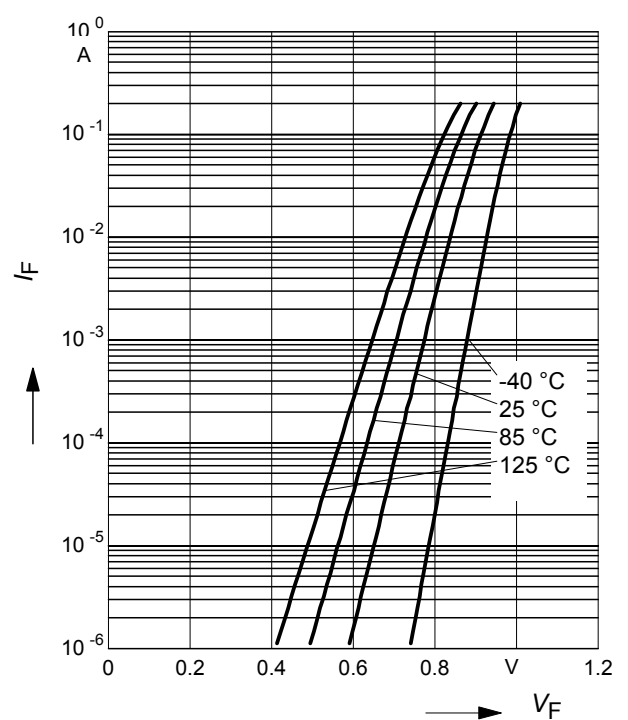

Forward current $I_F = f(T_S)$

BAR65-02L

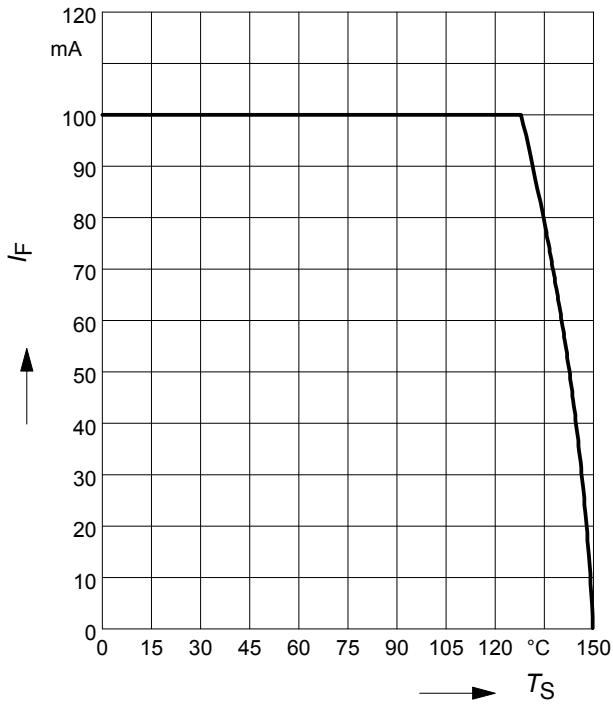

Forward current $I_F = f(T_S)$

BAR65-02V

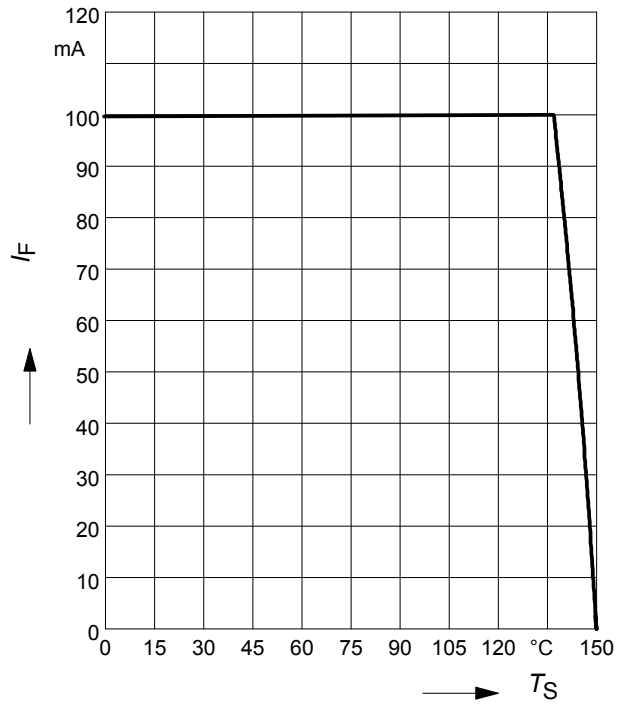

Forward current $I_F = f(T_S)$

BAR65-03W

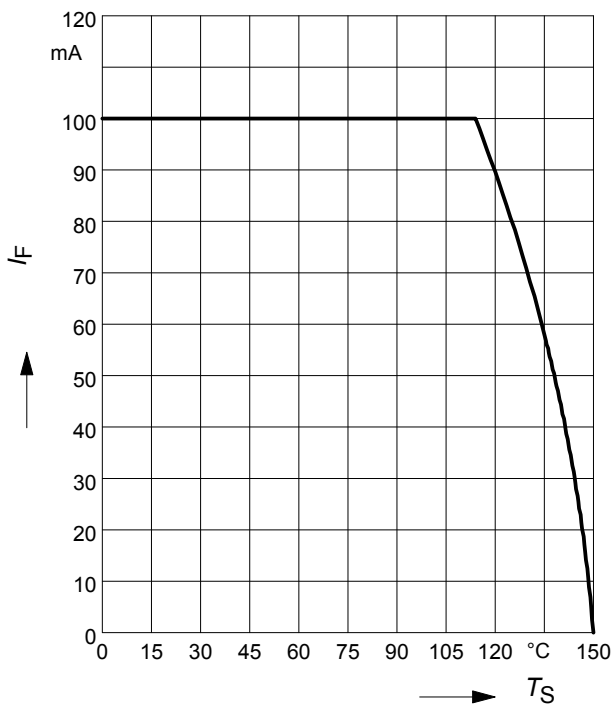

Permissible Puls Load $R_{thJS} = f(t_p)$

BAR65-02L

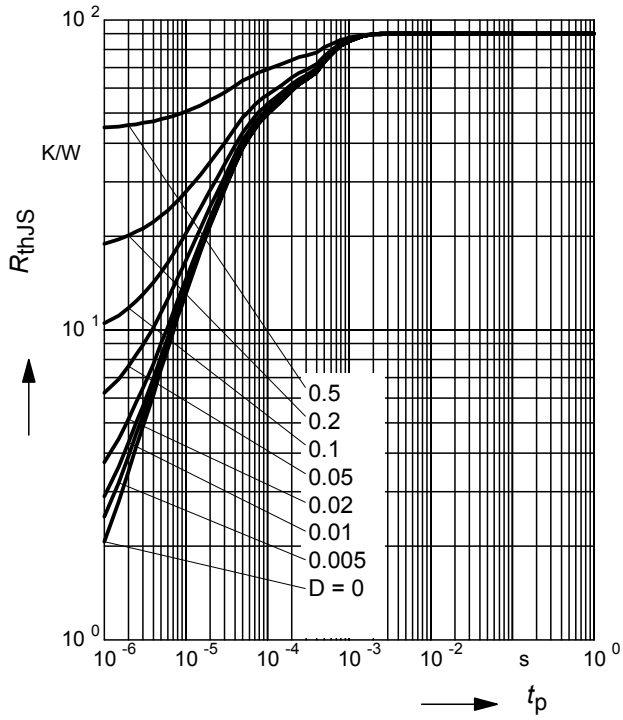

Permissible Pulse Load $I_{Fmax}/I_{FDC} = f(t_p)$

$I_{Fmax}/I_{FDC} = f(t_p)$

BAR65-02L

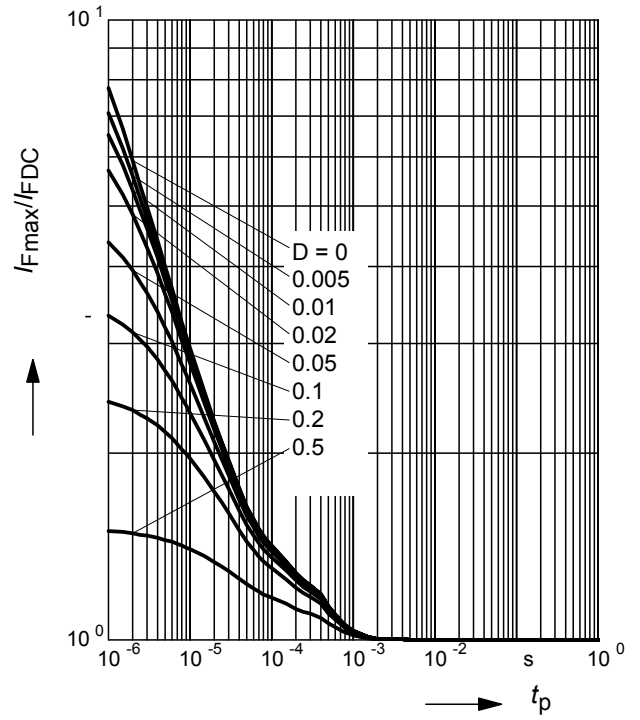

Permissible Puls Load $R_{thJS} = f(t_p)$

BAR65-02V

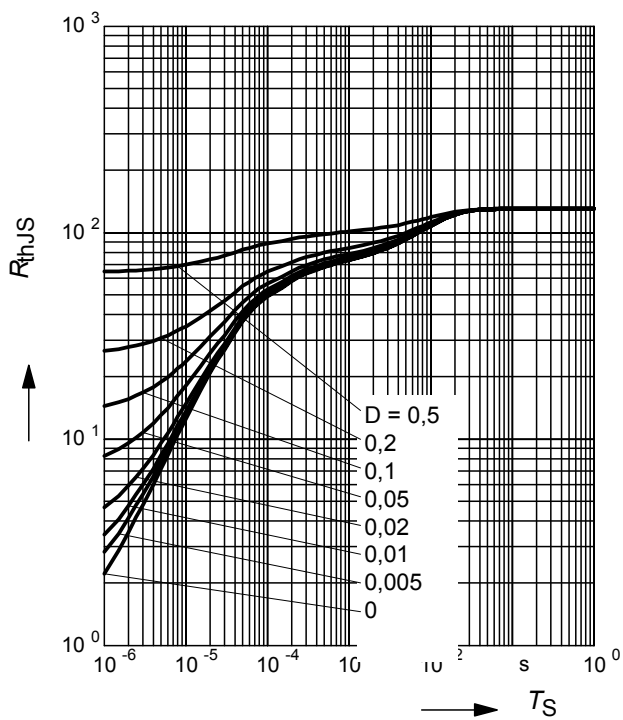

Permissible Pulse Load $I_{Fmax}/I_{FDC} = f(t_p)$

$I_{Fmax}/I_{FDC} = f(t_p)$

BAR65-02V

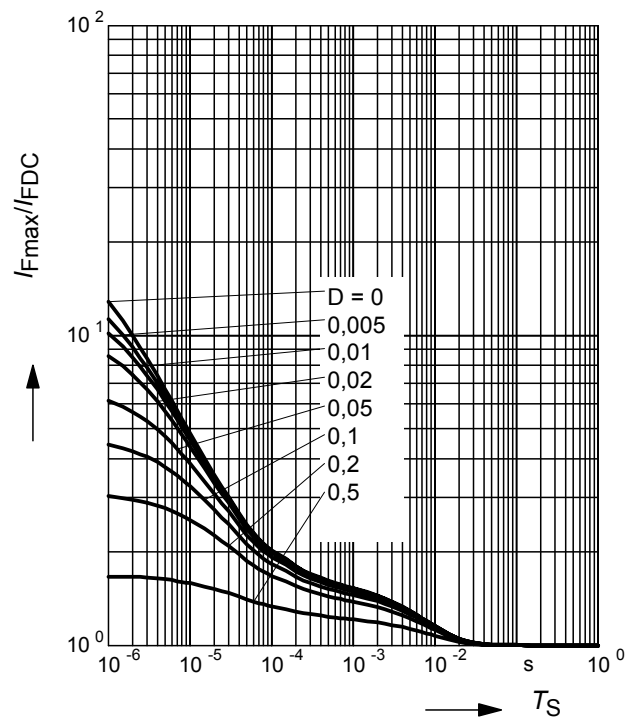

Permissible Puls Load $R_{thJS} = f(t_p)$

BAR65-03W

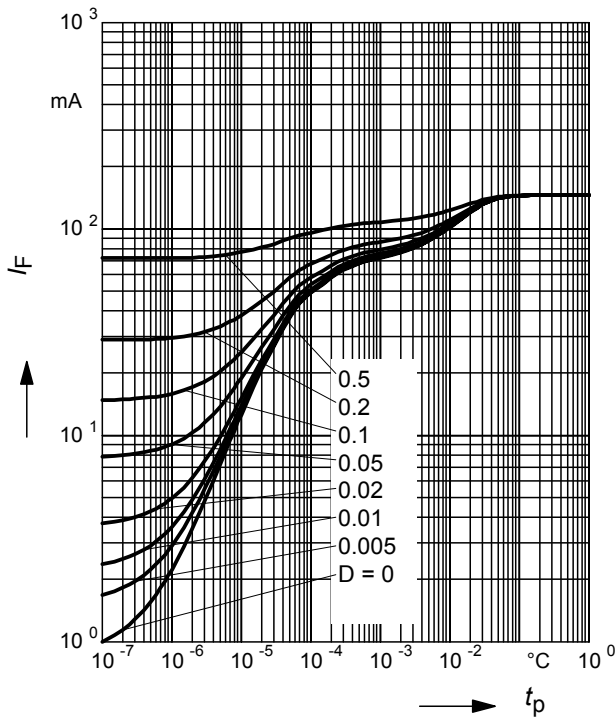

Permissible Pulse Load

$I_{Fmax} / I_{FDC} = f(t_p)$

BAR65-03W

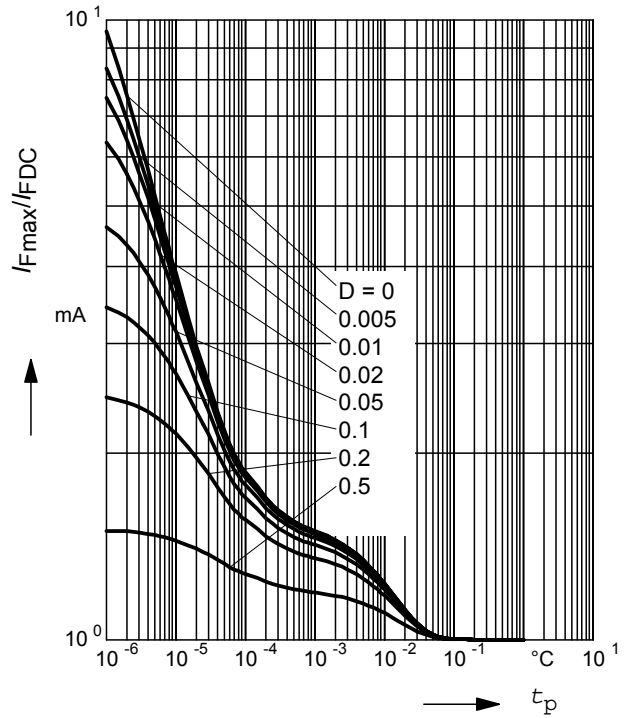

Insertion loss $I_L = -|S_{21}|^2 = f(f)$

I_F = Parameter

BAR65-02L in series configuration, $Z = 50\Omega$

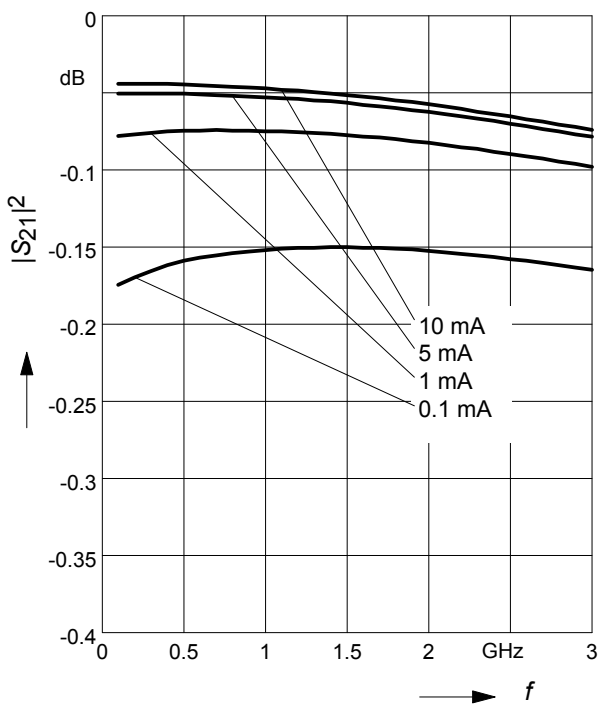

Isolation $I_{SO} = -|S_{21}|^2 = f(f)$

V_R = Parameter

BAR65-02L in series configuration $Z = 50\Omega$

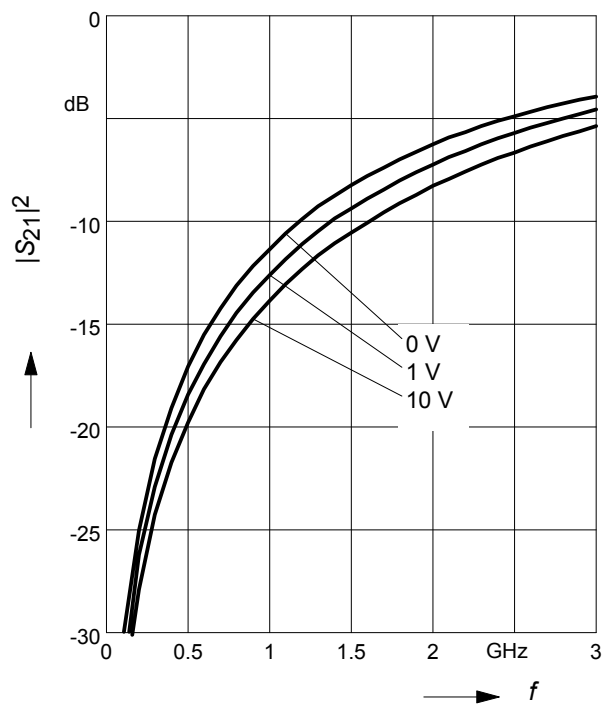

Package Outline

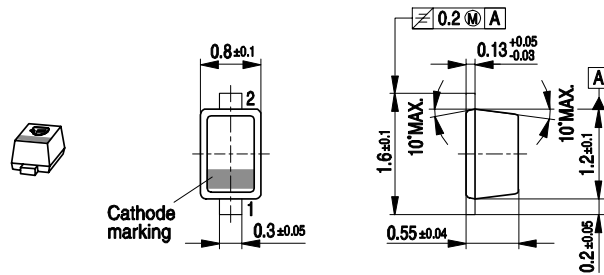

Foot Print

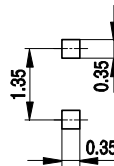

Marking Layout (Example)



Standard Packing

- Reel \varnothing 180 mm = 3.000 Pieces/Reel
- Reel \varnothing 180 mm = 8.000 Pieces/Reel (2 mm Pitch)
- Reel \varnothing 330 mm = 10.000 Pieces/Reel

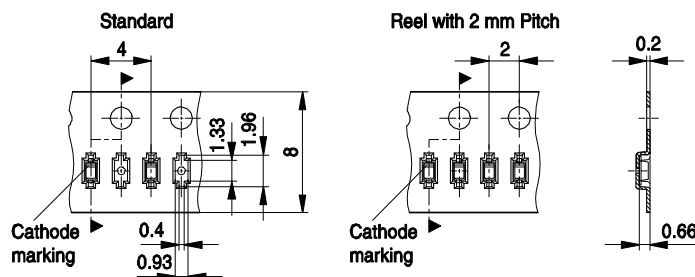

Date Code marking for discrete packages with one digit (SCD80, SC79, SC75¹⁾) CES-Code

| Month | 2003 | 2004 | 2005 | 2006 | 2007 | 2008 | 2009 | 2010 | 2011 | 2012 | 2013 | 2014 |
|-------|------|------|------|------|------|------|------|------|------|------|------|------|
| 01 | a | p | A | P | a | p | A | P | a | p | A | P |
| 02 | b | q | B | Q | b | q | B | Q | b | q | B | Q |
| 03 | c | r | C | R | c | r | C | R | c | r | C | R |
| 04 | d | s | D | S | d | s | D | S | d | s | D | S |
| 05 | e | t | E | T | e | t | E | T | e | t | E | T |
| 06 | f | u | F | U | f | u | F | U | f | u | F | U |
| 07 | g | v | G | V | g | v | G | V | g | v | G | V |
| 08 | h | x | H | X | h | x | H | X | h | x | H | X |
| 09 | j | y | J | Y | j | y | J | Y | j | y | J | Y |
| 10 | k | z | K | Z | k | z | K | Z | k | z | K | Z |
| 11 | l | 2 | L | 4 | l | 2 | L | 4 | l | 2 | L | 4 |
| 12 | n | 3 | N | 5 | n | 3 | N | 5 | n | 3 | N | 5 |

1) New Marking Layout for SC75, implemented at October 2005.

Package Outline

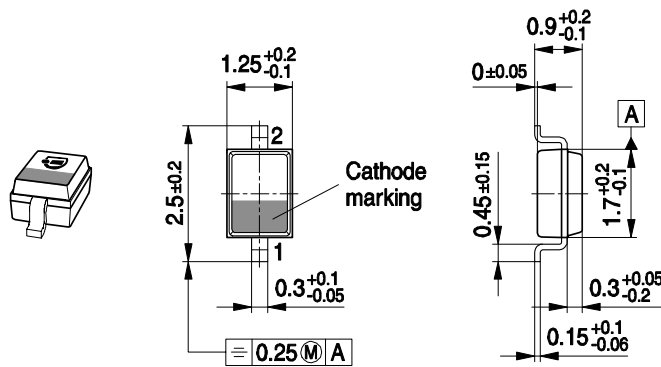

Foot Print

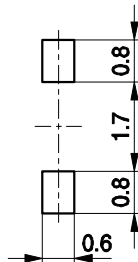

Marking Layout (Example)

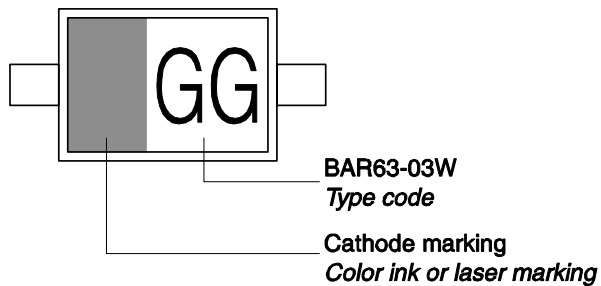

Standard Packing

Reel ø180 mm = 3.000 Pieces/Reel
 Reel ø330 mm = 10.000 Pieces/Reel

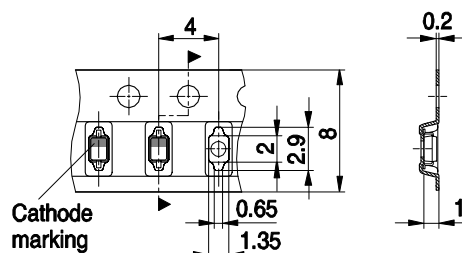

Package Outline

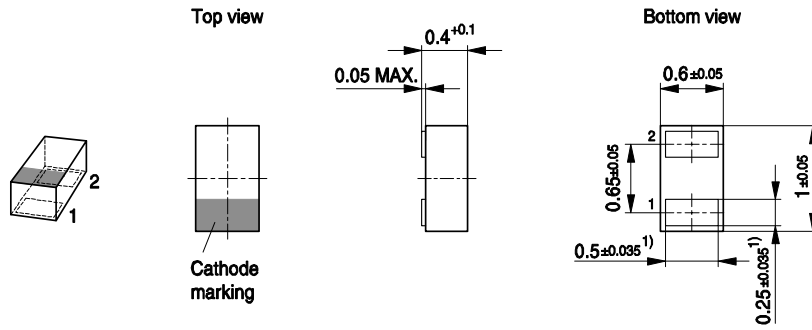

1) Dimension applies to plated terminal

Foot Print

For board assembly information please refer to Infineon website "Packages"

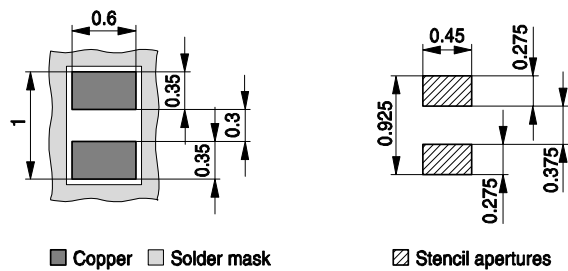

Marking Layout (Example)

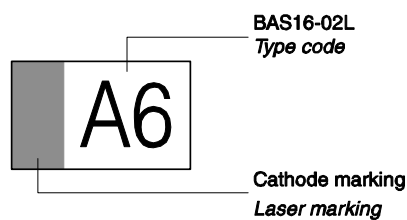

Standard Packing

Reel \varnothing 180 mm = 15.000 Pieces/Reel
 Reel \varnothing 330 mm = 50.000 Pieces/Reel (optional)

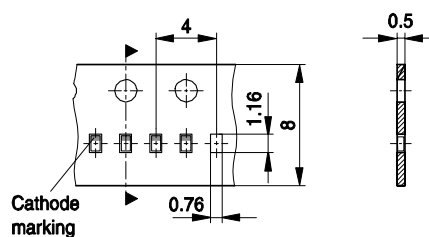

Edition 2009-11-16

**Published by
Infineon Technologies AG
81726 Munich, Germany**

**© 2009 Infineon Technologies AG
All Rights Reserved.**

Legal Disclaimer

The information given in this document shall in no event be regarded as a guarantee of conditions or characteristics. With respect to any examples or hints given herein, any typical values stated herein and/or any information regarding the application of the device, Infineon Technologies hereby disclaims any and all warranties and liabilities of any kind, including without limitation, warranties of non-infringement of intellectual property rights of any third party.

Information

For further information on technology, delivery terms and conditions and prices, please contact the nearest Infineon Technologies Office (www.infineon.com).

Warnings

Due to technical requirements, components may contain dangerous substances. For information on the types in question, please contact the nearest Infineon Technologies Office.

Infineon Technologies components may be used in life-support devices or systems only with the express written approval of Infineon Technologies, if a failure of such components can reasonably be expected to cause the failure of that life-support device or system or to affect the safety or effectiveness of that device or system. Life support devices or systems are intended to be implanted in the human body or to support and/or maintain and sustain and/or protect human life. If they fail, it is reasonable to assume that the health of the user or other persons may be endangered.

Mouser Electronics

Authorized Distributor

Click to View Pricing, Inventory, Delivery & Lifecycle Information:

[Infineon:](#)

[BAR6502VH6327XTSA1](#)