

HOA1873

Transmissive Sensor

FEATURES

- Choice of phototransistor or photodarlington output
- Three sensitivity ranges
- Choice of metal can package or plastic molded components
- 0.100 in.(2.54 mm) slot width

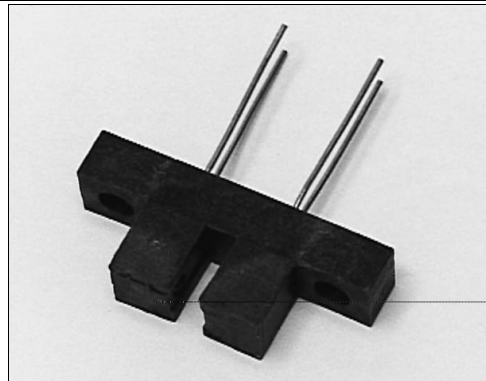

INFRA-13.TIF

DESCRIPTION

The HOA1873 series consists of an infrared emitting diode facing an NPN silicon phototransistor (HOA1873-001, -002, -011, -012) or photodarlington (HOA1873-003, -013) encased in a black thermoplastic housing. Detector switching takes place whenever an opaque object passes through the slot between emitter and detector. The HOA1873-001, -002, and -003 have a 0.050 in.(1.27 mm) dia. detector aperture and employ metal can packaged components, while the HOA1873-011, -012, and -013 have a 0.060 in.(1.52 mm) dia. detector aperture and contain plastic molded components. For additional component information see SE1450, SD1440, SD1410, SEP8506, SDP8406, and SDP8106.

HOA1873-001, 002, 003 housing material is acetal copolymer. HOA1873-011, 012, 013 housing material is polyester. Housings are soluble in chlorinated hydrocarbons and ketones. Recommended cleaning agents are methanol and isopropanol.

OUTLINE DIMENSIONS in inches (mm)

Tolerance 3 plc decimals $\pm 0.010(0.25)$
2 plc decimals $\pm 0.020(0.51)$

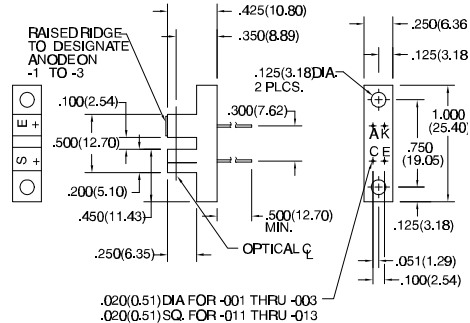

DIM_045.cdr

HOA1873

Transmissive Sensor

ELECTRICAL CHARACTERISTICS (25°C unless otherwise noted)

PARAMETER	SYMBOL	MIN	TYP	MAX	UNITS	TEST CONDITIONS
IR EMITTER						
Forward Voltage	V_F			1.6	V	$I_F=20\text{ mA}$
Reverse Leakage Current	I_R			10	μA	$V_R=3\text{ V}$
DETECTOR						
Collector-Emitter Breakdown Voltage HOA1873-001, -002, -011, -012 HOA1873-003, -013	$V_{(BR)CEO}$	30 15			V	$I_C=100\ \mu\text{A}$
Emitter-Collector Breakdown Voltage	$V_{(BR)ECO}$	5.0			V	$I_E=100\ \mu\text{A}$
Collector Dark Current HOA1873-001, -002, -011, -012 HOA1873-003, -013	I_{CEO}			100 250	nA	$V_{CE}=10\text{ V}$ $I_F=0$
COUPLED CHARACTERISTICS						
On-State Collector Current HOA1873-001, -011 HOA1873-002, -012 HOA1873-003, -013	$I_{C(ON)}$	0.3 1.8 4.0			mA	$V_{CE}=5\text{ V}$ $I_F=20\text{ mA}$
Collector-Emitter Saturation Voltage HOA1873-001, -011 HOA1873-002, -012 HOA1873-003, -013	$V_{CE(SAT)}$			0.4 0.4 1.1	V	$I_F=20\text{ mA}$ $I_C=40\ \mu\text{A}$ $I_C=230\ \mu\text{A}$ $I_C=500\ \mu\text{A}$
Rise And Fall Time HOA1873-001, -002, -011, -012 HOA1873-003, -013	t_r, t_f			15 75	μs	$V_{CC}=5\text{ V}, I_C=1\text{ mA}$ $R_L=1000\ \Omega$ $R_L=100\ \Omega$

ABSOLUTE MAXIMUM RATINGS

(25°C Free-Air Temperature unless otherwise noted)

Operating Temperature Range	
HOA1873-001, -002, -003	-55°C to 100°C
HOA1873-011, -012, -013	-40°C to 85°C
Storage Temperature Range	
HOA1873-001, -002, -003	-55°C to 125°C
HOA1873-011, -012, -013	-40°C to 85°C
Soldering Temperature	
HOA1873-001, -002, -003	260°C (10 sec)
HOA1873-011, -012, -013	240°C (5 sec)

IR EMITTER

Power Dissipation:	
HOA1873-001, -002, -003	75 mW
HOA1873-011, -012, -013	100 mW
Reverse Voltage	3 V

ABSOLUTE MAXIMUM RATINGS (continued)

Continuous Forward Current	50 mA	
DETECTOR	TRANS.	DARLINGTON
Collector-Emitter Voltage	30 V	15 V
Emitter-Collector Voltage	5 V	5 V
Power Dissipation		
HOA1873-001, -002, -003	75 mW ⁽¹⁾	75 mW ⁽¹⁾
HOA1873-011, -012, -013	100 mW ⁽²⁾	100 mW ⁽²⁾
Collector DC Current	30 mA	30 mA

Notes

- Derate linearly at 0.71 mW/°C above 25°C.
- Derate linearly at 0.78 mW/°C above 25°C.

Honeywell reserves the right to make changes in order to improve design and supply the best products possible.

Honeywell

HOA1873

Transmissive Sensor

SCHEMATIC

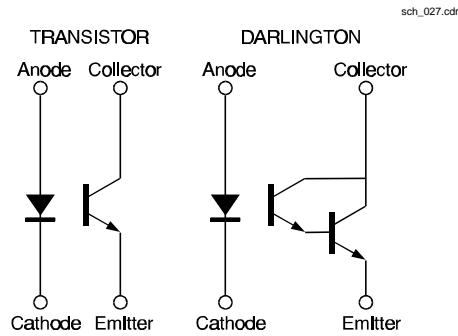

Fig. 2 Non-Saturated Switching Time vs Load Resistance

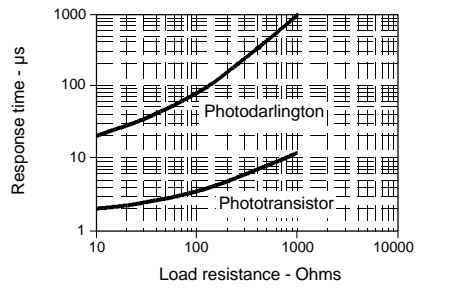

Fig. 4 Collector Current vs Ambient Temperature

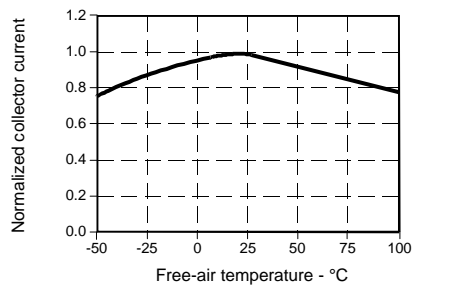

Fig. 1 IRED Forward Bias Characteristics

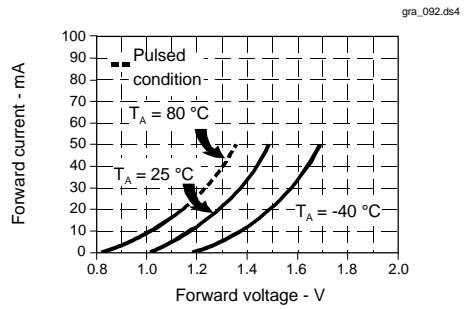
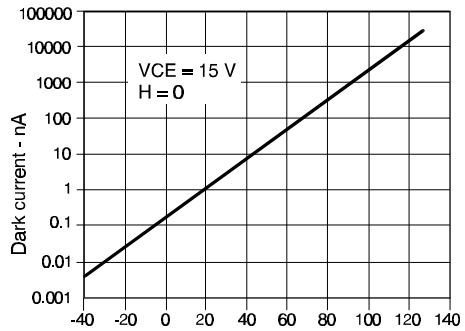

Fig. 3 Dark Current vs Temperature



All Performance Curves Show Typical Values

HOA1873
Transmissive Sensor

Honeywell reserves the right to make changes in order to improve design and supply the best products possible.

Honeywell

293

Mouser Electronics

Authorized Distributor

Click to View Pricing, Inventory, Delivery & Lifecycle Information:

[Honeywell:](#)

[HOA1873-011](#) [HOA1873-012](#) [HOA1873-013](#)