

# 0.5mm and 1mm Pitch FPC/FFC Connectors

## FH12 Series

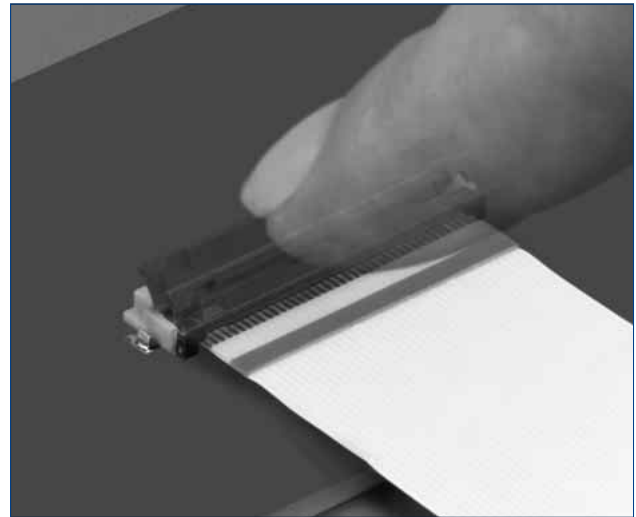
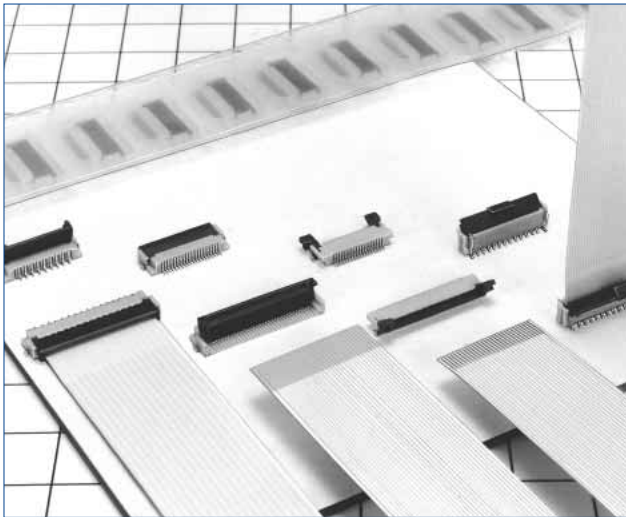

### ■ Features

#### 1. Rotating one-touch ZIF mechanism

The one-touch rotating ZIF mechanism is easier to operate and works with a light force.

#### 2. Clear tactile click

A clear tactile click is delivered upon the successful completion of the mating process.

#### 3. Supports high density mounting

The FH12's one-touch ZIF system requires less space than a slide locking connector and can be mounted in the center of the PCB.

#### 4. Top & Bottom Contact and Vertical Mount type

There are three connection types available : top contact, bottom contact and a Vertical mount.

#### 5. 1mm pitch product

In addition to the 0.5mm pitch connector, we also offer a 1mm pitch connector.

#### 6. Reinforced actuator

The FH12S version in 30, 40, 45, 50, and 53 pin counts are offered with a reinforced actuator that provides an extra measure of security against actuator breakage.

#### Rotating one-touch ZIF mechanism

①

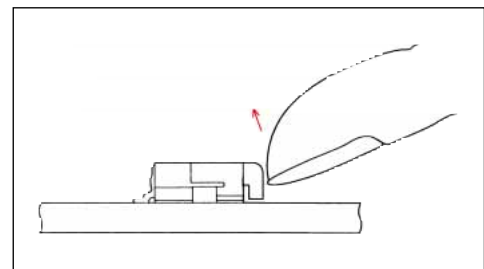

②

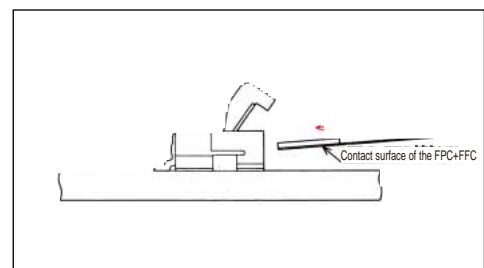

③

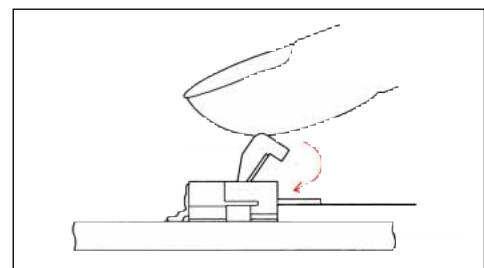

## Product Specifications

|        |                                  |                                                                       |                                                                     |
|--------|----------------------------------|-----------------------------------------------------------------------|---------------------------------------------------------------------|
| Rating | Current rating : 0.5A DC(Note 1) | Operating Temperature Range : -40 to +85°C (Note 2)                   | Storage Temperature Range : -10 to +50°C (Note 3)                   |
|        | Voltage rating : 50V AC          | Operating Humidity Range : Relative humidity, 90% max.<br>(Not dewed) | Storage Humidity Range : Relative humidity, 90% max.<br>(Not dewed) |

|                                         |                        |
|-----------------------------------------|------------------------|
| Adaptive FPC/FFC contact specifications | t=0.3±0.05 Gold plated |
|-----------------------------------------|------------------------|

| Item                                 | Specification                                                                                                                | Conditions                                                                                                    |
|--------------------------------------|------------------------------------------------------------------------------------------------------------------------------|---------------------------------------------------------------------------------------------------------------|
| 1. Insulation resistance             | 500MΩ minimum                                                                                                                | 100V DC                                                                                                       |
| 2. Withstanding voltage              | No flashover or insulation breakdown.                                                                                        | 150V AC/1 minute                                                                                              |
| 3. Contact resistance                | 50mΩ maximum                                                                                                                 | 1mA                                                                                                           |
| 4. Durability (Insertion/withdrawal) | Contact resistance : 50mΩ maximum<br>No damage, cracks, or parts dislocation.                                                | 20 cycles                                                                                                     |
| 5. Vibration                         | No electrical discontinuity of 1μs or more<br>Contact resistance : 50mΩ maximum.<br>No damage, cracks, or parts dislocation. | Frequency : 10 to 55Hz, single amplitude of 0.75mm, for 10 cycles in 3 axial directions                       |
| 6. Shock                             | No electrical discontinuity of 1μs or more<br>Contact resistance : 50mΩ maximum.<br>No damage, cracks, or parts dislocation. | Acceleration of 981m/s <sup>2</sup> , 6ms duration, sine half-wave waveform, 3 cycles in each of the 3 axis   |
| 7. Humidity(Steady state)            | Contact resistance : 50mΩ maximum.<br>Insulation resistance : 50MΩ minimum.<br>No damage, cracks, or parts dislocation.      | 96 hours at 40°C and humidity of 90% to 95%                                                                   |
| 8. Temperature Cycle                 | Contact resistance : 50mΩ maximum.<br>Insulation resistance : 50MΩ minimum.<br>No damage, cracks, or parts dislocation.      | Temperature : -40°C → 15 to 35°C → 85°C → 15 to 35°C,<br>Time: 30 → 2 to 3 → 30 → 2 to 3(minutes)<br>5 cycles |
| 9. Resistance to Soldering heat      | No deformation of components affecting performance.                                                                          | Reflow : At the recommended temperature profile<br>Manual soldering : 350±10°C for 5 seconds                  |

Note 1 : When passing the current through all of the contacts, use 70% of the current rating.

Note 2 : Includes temperature rise caused by current flow.

Note 3 : The term "storage" refers to products stored for long period of time prior to mounting and use. Operating Temperature Range and Humidity range covers nonconducting condition of installed connectors in storage, shipment or during transportation.

## Materials / Finish

| Part           | Material                | Finish             | Remarks |
|----------------|-------------------------|--------------------|---------|
| Insulator      | Polyamide, LCP(60 pos.) | Color : Beige      | UL94V-0 |
|                | PPS                     | Color : Dark brown |         |
| Contact        | Phosphor bronze         | Gold plated        | _____   |
| Metal Fittings | Brass                   | Tin plated         | _____   |

## Product Number Structure

Refer to the chart below when determining the product specifications from the product number.  
Please select from the product numbers listed in this catalog when placing orders.

**FH 12 A - 10 (4) S A - 0.5 SH (\*\*)**  

①
②
③
④
⑤
⑥
⑦
⑧
⑨
⑩

|                                                                                                  |                                                                                                                        |
|--------------------------------------------------------------------------------------------------|------------------------------------------------------------------------------------------------------------------------|
| ① Series Name : FH                                                                               | ⑥ Contact alignment : Single                                                                                           |
| ② Series No. : 12                                                                                | ⑦ Eccentric direction :<br>Blank : standard type<br>A : Eccentric type                                                 |
| ③ Blank : standard type<br>A : Top contact type<br>S : Type with strengthened flip-lock actuator |                                                                                                                        |
| ④ Standard type : Number of contacts<br>Eccentric type : Number of contacts in 0.5mm housing     | ⑧ Contacts Pitch : 0.5mm, 1mm                                                                                          |
| ⑤ Standard type : Blank<br>Eccentric type : Number of contacts                                   | ⑨ Contact type<br>SH : SMT horizontal mounting type<br>SVA : SMT vertical mounting type                                |
|                                                                                                  | ⑩ Plating specification<br>(54) : Selective gold plated<br>(55) : Gold plated<br>(1)(98) : Gold plated 500 pieces/reel |

## Series Configuration

| Pitch | Bottom Contact Type                                                                                                                                                                                                                                                                                                                                                                                                                | Top Contact Type                                                                                                                               | Vertical mounting Type                                                                                                                                                                                                                                                                                                   |                                                                                                                                                                                                                                              |                                                                                                                                                                                                                                                     |
|-------|------------------------------------------------------------------------------------------------------------------------------------------------------------------------------------------------------------------------------------------------------------------------------------------------------------------------------------------------------------------------------------------------------------------------------------|------------------------------------------------------------------------------------------------------------------------------------------------|--------------------------------------------------------------------------------------------------------------------------------------------------------------------------------------------------------------------------------------------------------------------------------------------------------------------------|----------------------------------------------------------------------------------------------------------------------------------------------------------------------------------------------------------------------------------------------|-----------------------------------------------------------------------------------------------------------------------------------------------------------------------------------------------------------------------------------------------------|
| 0.5mm |  <p><b>FH12- ** S-0.5SH</b> <span style="background-color: #0056b3; color: white; border-radius: 50%; padding: 2px;">P.4</span></p> <p>Number of contacts 6, 8, 10, 11, 12, 13, 14, 15, 16, 17, 18, 19, 20, 22, 24, 25, 26, 28, 30, 32, 33, 34, 35, 36, 40, 45, 50, 53</p>                                                                        |  <p>FPC insertion port</p> <p>FPC/FFC conductive surface</p> |  <p>FPC/FFC conductive surface(bottom side)</p>                                                                                                                                                                                       |                                                                                                                                                                                                                                              |                                                                                                                                                                                                                                                     |
|       | <p>Type with Strengthened Lock Lever</p>                                                                                                                                                                                                                                                                                                                                                                                           |                                                                                                                                                |                                                                                                                                                                                                                                                                                                                          | <p><b>FH12A- ** S-0.5SH</b> <span style="background-color: #0056b3; color: white; border-radius: 50%; padding: 2px;">P.6</span></p> <p>Number of contacts 10, 12, 15, 16, 18, 20, 22, 24, 26, 28, 29, 30, 32, 33, 34, 36, 40, 42, 45, 50</p> | <p><b>FH12- ** S-0.5SVA</b> <span style="background-color: #0056b3; color: white; border-radius: 50%; padding: 2px;">P.7</span></p> <p>Number of contacts 6, 10, 12, 13, 15, 16, 17, 18, 20, 22, 24, 26, 30, 32, 33, 34, 36, 40, 45, 49, 50, 60</p> |
|       | <p><b>FH12S- ** S-0.5SH</b> <span style="background-color: #0056b3; color: white; border-radius: 50%; padding: 2px;">P.5</span></p> <p>Number of contacts 30, 40, 45, 50, 53</p>                                                                                                                                                                                                                                                   |                                                                                                                                                |                                                                                                                                                                                                                                                                                                                          |                                                                                                                                                                                                                                              |                                                                                                                                                                                                                                                     |
| 1mm   |  <p>Standard <b>FH12- ** S-1SH</b> <span style="background-color: #0056b3; color: white; border-radius: 50%; padding: 2px;">P.8</span></p> <p>Eccentric <b>FH12- ** (***) SA-1SH</b></p> <p>Standard</p> <p>Number of contacts 5, 6, 7, 8, 9, 11, 12, 16, 17, 22, 26</p> <p>Eccentric</p> <p>Number of contacts 4, 6, 8, 10, 11, 14, 19, 24</p> |                                                                                                                                                |  <p>FPC/FFC conductive surface(bottom side)</p> <p><b>FH12- ** S-1SVA</b> <span style="background-color: #0056b3; color: white; border-radius: 50%; padding: 2px;">P.9</span></p> <p>Number of contacts 6, 7, 8, 16, 20, 22, 24</p> |                                                                                                                                                                                                                                              |                                                                                                                                                                                                                                                     |

## 0.5mm Pitch Bottom Contact Type



- Note 1 : The coplanarity of each terminal lead within specified dimension is 0.1mm Max.
- Note 2 : Packaged on tape and reel only. Check packaging specification.
- Note 3 : Slight variations in color of the plastic compounds do not affect form, fit or function of the connector.
- Note 4 : After reflow, the terminal plating may change color, however this does not represent a quality issue.
- Note ⑤ : If there is no problem with the connector height, we recommend the type with the strengthened Flip-lock actuator (FH12S-\*S-0.5SH). Standard type connector height : 2mm Connector height of type with strengthened Flip-lock actuator : 2.4mm

Unit : mm

| Part No.                  | HRS No.       | No. of Contacts | A    | B    | C    | D     |
|---------------------------|---------------|-----------------|------|------|------|-------|
| FH12-6S-0.5SH(**)         | 586-0582-5 ** | 6               | 2.5  | 6.1  | 7.1  | 3.57  |
| FH12-8S-0.5SH(**)         | 586-0744-5 ** | 8               | 3.5  | 7.1  | 8.1  | 4.57  |
| FH12-10S-0.5SH(**)        | 586-0522-3 ** | 10              | 4.5  | 8.1  | 9.1  | 5.57  |
| FH12-11S-0.5SH(**)        | 586-0600-5 ** | 11              | 5.0  | 8.6  | 9.6  | 6.07  |
| FH12-12S-0.5SH(**)        | 586-0704-0 ** | 12              | 5.5  | 9.1  | 10.1 | 6.57  |
| FH12-13S-0.5SH(**)        | 586-0549-0 ** | 13              | 6.0  | 9.6  | 10.6 | 7.07  |
| FH12-14S-0.5SH(**)        | 586-0533-0 ** | 14              | 6.5  | 10.1 | 11.1 | 7.57  |
| FH12-15S-0.5SH(**)        | 586-0523-6 ** | 15              | 7.0  | 10.6 | 11.6 | 8.07  |
| FH12-16S-0.5SH(**)        | 586-0531-4 ** | 16              | 7.5  | 11.1 | 12.1 | 8.57  |
| FH12-17S-0.5SH(**)        | 586-0606-1 ** | 17              | 8.0  | 11.6 | 12.6 | 9.07  |
| FH12-18S-0.5SH(**)        | 586-0530-1 ** | 18              | 8.5  | 12.1 | 13.1 | 9.57  |
| FH12-19S-0.5SH(**)        | 586-0534-2 ** | 19              | 9.0  | 12.6 | 13.6 | 10.07 |
| FH12-20S-0.5SH(**)        | 586-0524-9 ** | 20              | 9.5  | 13.1 | 14.1 | 10.57 |
| FH12-22S-0.5SH(**)        | 586-0532-7 ** | 22              | 10.5 | 14.1 | 15.1 | 11.57 |
| FH12-24S-0.5SH(**)        | 586-0521-0 ** | 24              | 11.5 | 15.1 | 16.1 | 12.57 |
| FH12-25S-0.5SH(**)        | 586-0692-3 ** | 25              | 12.0 | 15.6 | 16.6 | 13.07 |
| FH12-26S-0.5SH(**)        | 586-0576-2 ** | 26              | 12.5 | 16.1 | 17.1 | 13.57 |
| FH12-28S-0.5SH(**)        | 586-0612-4 ** | 28              | 13.5 | 17.1 | 18.1 | 14.57 |
| Note ⑤ FH12-30S-0.5SH(**) | 586-0525-1 ** | 30              | 14.5 | 18.1 | 19.1 | 15.57 |
| FH12-32S-0.5SH(**)        | 586-0681-7 ** | 32              | 15.5 | 19.1 | 20.1 | 16.57 |
| FH12-33S-0.5SH(**)        | 586-0520-8 ** | 33              | 16.0 | 19.6 | 20.6 | 17.07 |
| FH12-34S-0.5SH(**)        | 586-0617-8 ** | 34              | 16.5 | 20.1 | 21.1 | 17.57 |
| FH12-35S-0.5SH(**)        | 586-0740-4 ** | 35              | 17.0 | 20.6 | 21.6 | 18.07 |
| FH12-36S-0.5SH(**)        | 586-0526-4 ** | 36              | 17.5 | 21.1 | 22.1 | 18.57 |
| Note ⑤ FH12-40S-0.5SH(**) | 586-0527-7 ** | 40              | 19.5 | 23.1 | 24.1 | 20.57 |
| Note ⑤ FH12-45S-0.5SH(**) | 586-0528-0 ** | 45              | 22.0 | 25.6 | 26.6 | 23.07 |
| Note ⑤ FH12-50S-0.5SH(**) | 586-0529-2 ** | 50              | 24.5 | 28.1 | 29.1 | 25.57 |
| Note ⑤ FH12-53S-0.5SH(**) | 586-0595-7 ** | 53              | 26.0 | 29.6 | 30.6 | 27.07 |

Note 1 : Embossed tape reel packaging (2,000 pcs/reel, 500 pcs/reel). Order by number of reels.

## 0.5mm Pitch Bottom Contact Type with Strengthened Flip-lock Actuator

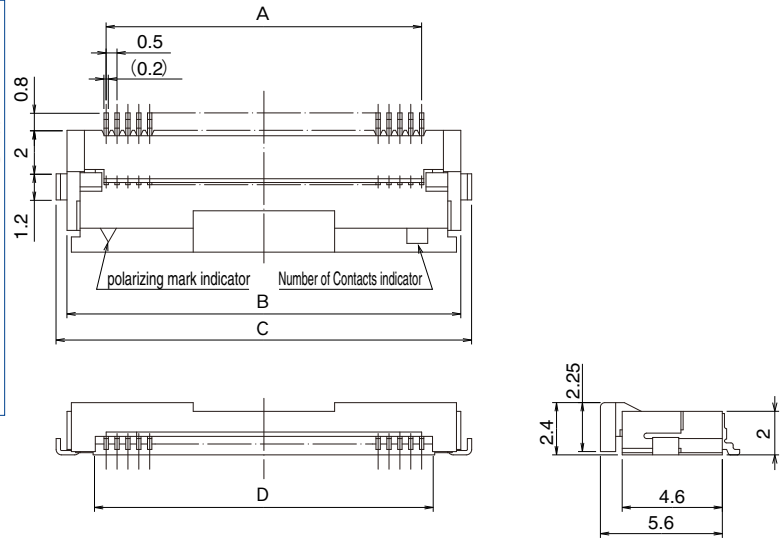

- Note 1 : The coplanarity of each terminal lead within specified dimension is 0.1mm Max.
- Note 2 : Packaged on tape and reel only. Check packaging specification.
- Note 3 : Slight variations in color of the plastic compounds do not affect form, fit or function of the connector.
- Note 4 : After reflow, the terminal plating may change color, however this does not represent a quality issue.

Unit : mm

| Part No.            | HRS No.       | No. of Contacts | A    | B    | C    | D     |
|---------------------|---------------|-----------------|------|------|------|-------|
| FH12S-30S-0.5SH(**) | 586-0667-6 ** | 30              | 14.5 | 18.1 | 19.1 | 15.57 |
| FH12S-40S-0.5SH(**) | 586-0640-0 ** | 40              | 19.5 | 23.1 | 24.1 | 20.57 |
| FH12S-45S-0.5SH(**) | 586-0665-0 ** | 45              | 22.0 | 25.6 | 26.6 | 23.07 |
| FH12S-50S-0.5SH(**) | 586-0642-5 ** | 50              | 24.5 | 28.1 | 29.1 | 25.57 |
| FH12S-53S-0.5SH(**) | 586-0691-0 ** | 53              | 26.0 | 29.6 | 30.6 | 27.07 |

- Note 1 : Embossed tape reel packaging (2,000 pcs/reel, 500 pcs/reel).  
Order by number of reels.

## 0.5mm Pitch Top Contact Type

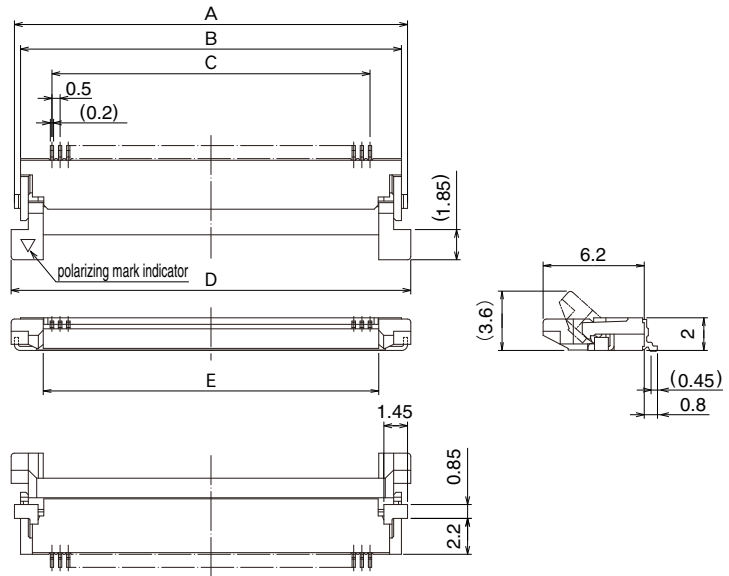

Note 1 : The coplanarity of each terminal lead within specified dimension is 0.1mm Max.

Note 2 : Packaged on tape and reel only. Check packaging specification.

Note 3 : Slight variations in color of the plastic compounds do not affect form, fit or function of the connector.

Note 4 : After reflow, the terminal plating may change color, however this does not represent a quality issue.

Unit : mm

| Part No.            | HRS No.       | No. of Contacts | A    | B     | C    | D    | E     |
|---------------------|---------------|-----------------|------|-------|------|------|-------|
| FH12A-10S-0.5SH(**) | 586-0550-9 ** | 10              | 9.1  | 8.35  | 4.5  | 9.5  | 5.57  |
| FH12A-12S-0.5SH(**) | 586-0696-4 ** | 12              | 10.1 | 9.35  | 5.5  | 10.5 | 6.57  |
| FH12A-15S-0.5SH(**) | 586-0551-1 ** | 15              | 11.6 | 10.85 | 7.0  | 12.0 | 8.07  |
| FH12A-16S-0.5SH(**) | 586-0552-4 ** | 16              | 12.1 | 11.35 | 7.5  | 12.5 | 8.57  |
| FH12A-18S-0.5SH(**) | 586-0553-7 ** | 18              | 13.1 | 12.35 | 8.5  | 13.5 | 9.57  |
| FH12A-20S-0.5SH(**) | 586-0554-0 ** | 20              | 14.1 | 13.35 | 9.5  | 14.5 | 10.57 |
| FH12A-22S-0.5SH(**) | 586-0686-0 ** | 22              | 15.1 | 14.35 | 10.5 | 15.5 | 11.57 |
| FH12A-24S-0.5SH(**) | 586-0555-2 ** | 24              | 16.1 | 15.35 | 11.5 | 16.5 | 12.57 |
| FH12A-26S-0.5SH(**) | 586-0663-5 ** | 26              | 17.1 | 16.35 | 12.5 | 17.5 | 13.57 |
| FH12A-28S-0.5SH(**) | 586-0725-0 ** | 28              | 18.1 | 17.35 | 13.5 | 18.5 | 14.57 |
| FH12A-29S-0.5SH(**) | 586-0585-3 ** | 29              | 18.6 | 17.85 | 14.0 | 19.0 | 15.07 |
| FH12A-30S-0.5SH(**) | 586-0556-5 ** | 30              | 19.1 | 18.35 | 14.5 | 19.5 | 15.57 |
| FH12A-32S-0.5SH(**) | 586-0687-3 ** | 32              | 20.1 | 19.35 | 15.5 | 20.5 | 16.57 |
| FH12A-33S-0.5SH(**) | 586-0570-6 ** | 33              | 20.6 | 19.85 | 16.0 | 21.0 | 17.07 |
| FH12A-34S-0.5SH(**) | 586-0670-0 ** | 34              | 21.1 | 20.35 | 16.5 | 21.5 | 17.57 |
| FH12A-36S-0.5SH(**) | 586-0662-2 ** | 36              | 22.1 | 21.35 | 17.5 | 22.5 | 18.57 |
| FH12A-40S-0.5SH(**) | 586-0557-8 ** | 40              | 24.1 | 23.35 | 19.5 | 24.5 | 20.57 |
| FH12A-42S-0.5SH(**) | 586-0698-0 ** | 42              | 25.1 | 24.35 | 20.5 | 25.5 | 21.57 |
| FH12A-45S-0.5SH(**) | 586-0558-0 ** | 45              | 26.6 | 25.85 | 22.0 | 27.0 | 23.07 |
| FH12A-50S-0.5SH(**) | 586-0559-3 ** | 50              | 29.1 | 28.35 | 24.5 | 29.5 | 25.57 |

Note 1 : Embossed tape reel packaging (2,000 pcs/reel).

Order by number of reels.

## 0.5mm Pitch Vertical mounting Type

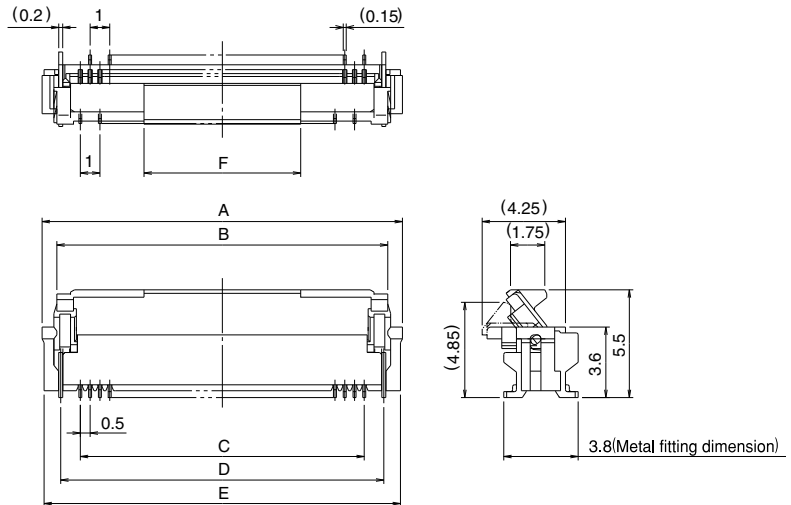
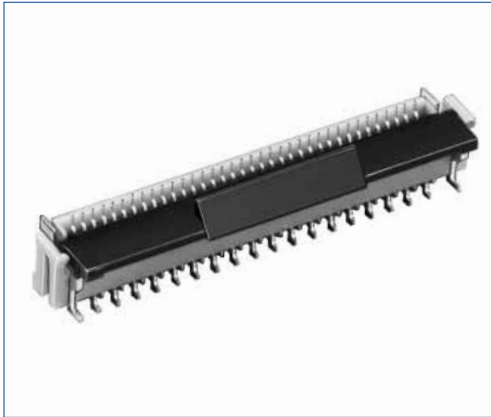

Note 1 : The coplanarity of each terminal lead within specified dimension is 0.1mm Max.

Note 2 : Packaged on tape and reel only. Check packaging specification.

Note 3 : Slight variations in color of the plastic compounds do not affect form, fit or function of the connector.

Note 4 : After reflow, the terminal plating may change color, however this does not represent a quality issue.

Unit : mm

| Part No.             | HRS No.       | No. of Contacts | A    | B    | C    | D    | E    | F |
|----------------------|---------------|-----------------|------|------|------|------|------|---|
| FH12-6S-0.5SVA (54)  | 586-0756-4 54 | 6               | 6.4  | 4.9  | 2.5  | 4.5  | 6.2  | 4 |
| FH12-10S-0.5SVA (54) | 586-0806-0 54 | 10              | 8.4  | 6.9  | 4.5  | 6.5  | 8.2  | 4 |
| FH12-12S-0.5SVA (54) | 586-0757-7 54 | 12              | 9.4  | 7.9  | 5.5  | 7.5  | 9.2  | 4 |
| FH12-13S-0.5SVA (54) | 586-0807-3 54 | 13              | 9.9  | 8.4  | 6.0  | 8.0  | 9.7  | 4 |
| FH12-15S-0.5SVA (54) | 586-0808-6 54 | 15              | 10.9 | 9.4  | 7.0  | 9.0  | 10.7 | 4 |
| FH12-16S-0.5SVA (54) | 586-0809-9 54 | 16              | 11.4 | 9.9  | 7.5  | 9.5  | 11.2 | 4 |
| FH12-17S-0.5SVA (54) | 586-0810-8 54 | 17              | 11.9 | 10.4 | 8.0  | 10.0 | 11.7 | 4 |
| FH12-18S-0.5SVA (54) | 586-0811-0 54 | 18              | 12.4 | 10.9 | 8.5  | 10.5 | 12.2 | 4 |
| FH12-20S-0.5SVA (54) | 586-0812-3 54 | 20              | 13.4 | 11.9 | 9.5  | 11.5 | 13.2 | 4 |
| FH12-22S-0.5SVA (54) | 586-0813-6 54 | 22              | 14.4 | 12.9 | 10.5 | 12.5 | 14.2 | 8 |
| FH12-24S-0.5SVA (54) | 586-0814-9 54 | 24              | 15.4 | 13.9 | 11.5 | 13.5 | 15.2 | 8 |
| FH12-26S-0.5SVA (54) | 586-0815-1 54 | 26              | 16.4 | 14.9 | 12.5 | 14.5 | 16.2 | 8 |
| FH12-30S-0.5SVA (54) | 586-0750-8 54 | 30              | 18.4 | 16.9 | 14.5 | 16.5 | 18.2 | 8 |
| FH12-32S-0.5SVA (54) | 586-0816-4 54 | 32              | 19.4 | 17.9 | 15.5 | 17.5 | 19.2 | 8 |
| FH12-33S-0.5SVA (54) | 586-0818-0 54 | 33              | 19.9 | 18.4 | 16.0 | 18.0 | 19.7 | 8 |
| FH12-34S-0.5SVA (54) | 586-0817-7 54 | 34              | 20.4 | 18.9 | 16.5 | 18.5 | 20.2 | 8 |
| FH12-36S-0.5SVA (54) | 586-0819-2 54 | 36              | 21.4 | 19.9 | 17.5 | 19.5 | 21.2 | 8 |
| FH12-40S-0.5SVA (54) | 586-0804-5 54 | 40              | 23.4 | 21.9 | 19.5 | 21.5 | 23.2 | 8 |
| FH12-45S-0.5SVA (54) | 586-0820-1 54 | 45              | 25.9 | 24.4 | 22.0 | 24.0 | 25.7 | 8 |
| FH12-49S-0.5SVA (54) | 586-0821-4 54 | 49              | 27.9 | 26.4 | 24.0 | 26.0 | 27.7 | 8 |
| FH12-50S-0.5SVA (54) | 586-0805-8 54 | 50              | 28.4 | 26.9 | 24.5 | 26.5 | 28.2 | 8 |
| FH12-60S-0.5SVA (54) | 586-0749-9 54 | 60              | 33.4 | 31.9 | 29.5 | 31.5 | 33.2 | 8 |

Note 1 : Embossed tape reel packaging (1,000 pcs/reel, 500 pcs/reel).

Order by number of reels.

## 1mm Pitch Type Bottom Contact Type

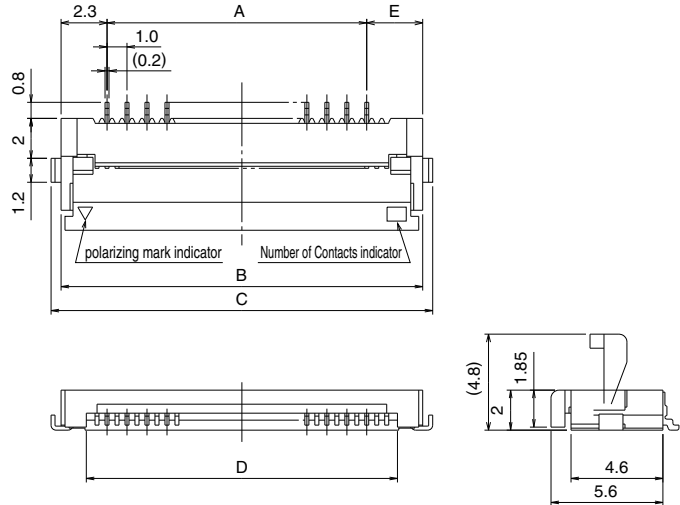

Note 1 : The coplanarity of each terminal lead within specified dimension is 0.1mm Max.

Note 2 : Packaged on tape and reel only. Check packaging specification.

Note 3 : Slight variations in color of the plastic compounds do not affect form, fit or function of the connector.

Note 4 : After reflow, the terminal plating may change color, however this does not represent a quality issue.

Unit : mm

|                | Part No.              | HRS No.       | No. of Contacts | A  | B    | C    | D     | E   |
|----------------|-----------------------|---------------|-----------------|----|------|------|-------|-----|
| Standard type  | FH12-5S-1SH(**)       | 586-0591-6 ** | 5               | 4  | 8.6  | 9.6  | 6.07  | 2.3 |
|                | FH12-6S-1SH(**)       | 586-0607-4 ** | 6               | 5  | 9.6  | 10.6 | 7.07  | 2.3 |
|                | FH12-7S-1SH(**)       | 586-0535-5 ** | 7               | 6  | 10.6 | 11.6 | 8.07  | 2.3 |
|                | FH12-8S-1SH(**)       | 586-0579-0 ** | 8               | 7  | 11.6 | 12.6 | 9.07  | 2.3 |
|                | FH12-9S-1SH(**)       | 586-0540-5 ** | 9               | 8  | 12.6 | 13.6 | 10.07 | 2.3 |
|                | FH12-11S-1SH(**)      | 586-0668-9 ** | 11              | 10 | 14.6 | 15.6 | 12.07 | 2.3 |
|                | FH12-12S-1SH(**)      | 586-0741-7 ** | 12              | 11 | 15.6 | 16.6 | 13.07 | 2.3 |
|                | FH12-16S-1SH(**)      | 586-0536-8 ** | 16              | 15 | 19.6 | 20.6 | 17.07 | 2.3 |
|                | FH12-17S-1SH(**)      | 586-0739-5 ** | 17              | 16 | 20.6 | 21.6 | 18.07 | 2.3 |
|                | FH12-22S-1SH(**)      | 586-0547-4 ** | 22              | 21 | 25.6 | 26.6 | 23.07 | 2.3 |
|                | FH12-26S-1SH(**)      | 586-0592-9 ** | 26              | 25 | 29.6 | 30.6 | 27.07 | 2.3 |
| Eccentric type | FH12-10(4)SA-1SH(**)  | 586-0537-0 ** | 4               | 3  | 8.1  | 9.1  | 5.57  | 2.8 |
|                | FH12-14(6)SA-1SH(**)  | 586-0538-3 ** | 6               | 5  | 10.1 | 11.1 | 7.57  | 2.8 |
|                | FH12-18(8)SA-1SH(**)  | 586-0539-6 ** | 8               | 7  | 12.1 | 13.1 | 9.57  | 2.8 |
|                | FH12-22(10)SA-1SH(**) | 586-0541-8 ** | 10              | 9  | 14.1 | 15.1 | 11.57 | 2.8 |
|                | FH12-24(11)SA-1SH(**) | 586-0542-0 ** | 11              | 10 | 15.1 | 16.1 | 12.57 | 2.8 |
|                | FH12-30(14)SA-1SH(**) | 586-0543-3 ** | 14              | 13 | 18.1 | 19.1 | 15.57 | 2.8 |
|                | FH12-40(19)SA-1SH(**) | 586-0546-1 ** | 19              | 18 | 23.1 | 24.1 | 20.57 | 2.8 |
|                | FH12-50(24)SA-1SH(**) | 586-0548-7 ** | 24              | 23 | 28.1 | 29.1 | 25.57 | 2.8 |

Note 1 : Embossed tape reel packaging (2,000 pcs/reel, 500 pcs/reel).  
Order by number of reels.



## 1mm Pitch Vertical Mounting Type



Note 1 : The coplanarity of each terminal lead within specified dimension is 0.1mm Max.

Note 2 : Packaged on tape and reel only. Check packaging specification.

Note 3 : Slight variations in color of the plastic compounds do not affect form, fit or function of the connector.

Note 4 : After reflow, the terminal plating may change color, however this does not represent a quality issue.

Unit : mm

| Part No.           | HRS No.       | No. of Contacts | A    | B    | C  | D  | E    | F |
|--------------------|---------------|-----------------|------|------|----|----|------|---|
| FH12- 6S-1SVA (54) | 586-0822-0 54 | 6               | 9.9  | 8.4  | 5  | 8  | 9.7  | 4 |
| FH12- 7S-1SVA (54) | 586-0823-0 54 | 7               | 10.9 | 9.4  | 6  | 9  | 10.7 | 4 |
| FH12- 8S-1SVA (54) | 586-0824-0 54 | 8               | 11.9 | 10.4 | 7  | 10 | 11.7 | 4 |
| FH12-16S-1SVA (54) | 586-0825-0 54 | 16              | 19.9 | 18.4 | 15 | 18 | 19.7 | 8 |
| FH12-20S-1SVA (54) | 586-0826-0 54 | 20              | 23.9 | 22.4 | 19 | 22 | 23.7 | 8 |
| FH12-22S-1SVA (54) | 586-0827-0 54 | 22              | 25.9 | 24.4 | 21 | 24 | 25.7 | 8 |
| FH12-24S-1SVA (54) | 586-0828-0 54 | 24              | 27.9 | 26.4 | 23 | 26 | 27.7 | 8 |

Note 1 : Embossed tape reel packaging (1,000 pcs/reel, 500 pcs/reel).  
Order by number of reels.

## Recommended FPC/FFC dimensions and Land/Metal Mask dimensions

### 0.5mm Pitch Product

|                                                                                   | FPC/FFC dimensions                                                                                                                                                                                                                                                                                                                                                                                                                                                                                                                                                                                                                                                                                                                                                                                                                                                                                                                                                                                                                                                                                                                                                                                                                                                                                                                                                                                                                                                                                                             | Land / Metal Mask dimensions    |                    |                    |           |      |      |   |                    |           |   |     |     |    |           |    |     |     |    |           |    |     |     |    |           |    |     |     |    |           |    |     |     |    |           |    |     |     |    |           |    |     |     |    |           |    |     |     |    |           |    |     |      |    |           |    |      |      |    |           |    |      |      |    |           |                                                                                                                                                                                                                                                                                                                                                                                                                                                                                                                                                                                                                                                                                                                                                                                                                                                                                                                                                                                                                                                                                                                                                                                                  |                                 |      |    |           |    |     |      |                    |           |    |      |      |    |           |    |      |      |    |           |                                                                                                                                                                                                                                                                                                                                                                                                                                                                                                                                                                                                                                                                                                                                                                                                                                                                                                                                                                                                                                                                                                                                                                                                                                                                                                                                                                                                                                                                                                                                                                                                                                                                                                                                                                                                                                                                                                                                                                                                                                                                                         |                                 |     |    |           |    |     |     |    |           |    |                    |           |    |           |    |      |     |     |           |    |      |      |      |           |     |      |     |    |           |      |      |      |     |           |     |      |      |      |           |    |     |      |     |           |      |      |      |    |     |      |     |    |      |      |      |    |     |      |     |    |      |      |      |    |     |      |     |    |      |      |      |    |     |      |     |    |      |      |      |    |     |      |     |    |      |      |      |    |     |      |      |    |      |      |      |    |     |      |      |    |      |      |      |    |     |      |      |    |      |      |      |    |     |      |      |    |      |      |      |    |      |      |      |    |      |      |      |    |      |      |      |    |      |      |      |
|-----------------------------------------------------------------------------------|--------------------------------------------------------------------------------------------------------------------------------------------------------------------------------------------------------------------------------------------------------------------------------------------------------------------------------------------------------------------------------------------------------------------------------------------------------------------------------------------------------------------------------------------------------------------------------------------------------------------------------------------------------------------------------------------------------------------------------------------------------------------------------------------------------------------------------------------------------------------------------------------------------------------------------------------------------------------------------------------------------------------------------------------------------------------------------------------------------------------------------------------------------------------------------------------------------------------------------------------------------------------------------------------------------------------------------------------------------------------------------------------------------------------------------------------------------------------------------------------------------------------------------|---------------------------------|--------------------|--------------------|-----------|------|------|---|--------------------|-----------|---|-----|-----|----|-----------|----|-----|-----|----|-----------|----|-----|-----|----|-----------|----|-----|-----|----|-----------|----|-----|-----|----|-----------|----|-----|-----|----|-----------|----|-----|-----|----|-----------|----|-----|-----|----|-----------|----|-----|------|----|-----------|----|------|------|----|-----------|----|------|------|----|-----------|--------------------------------------------------------------------------------------------------------------------------------------------------------------------------------------------------------------------------------------------------------------------------------------------------------------------------------------------------------------------------------------------------------------------------------------------------------------------------------------------------------------------------------------------------------------------------------------------------------------------------------------------------------------------------------------------------------------------------------------------------------------------------------------------------------------------------------------------------------------------------------------------------------------------------------------------------------------------------------------------------------------------------------------------------------------------------------------------------------------------------------------------------------------------------------------------------|---------------------------------|------|----|-----------|----|-----|------|--------------------|-----------|----|------|------|----|-----------|----|------|------|----|-----------|-----------------------------------------------------------------------------------------------------------------------------------------------------------------------------------------------------------------------------------------------------------------------------------------------------------------------------------------------------------------------------------------------------------------------------------------------------------------------------------------------------------------------------------------------------------------------------------------------------------------------------------------------------------------------------------------------------------------------------------------------------------------------------------------------------------------------------------------------------------------------------------------------------------------------------------------------------------------------------------------------------------------------------------------------------------------------------------------------------------------------------------------------------------------------------------------------------------------------------------------------------------------------------------------------------------------------------------------------------------------------------------------------------------------------------------------------------------------------------------------------------------------------------------------------------------------------------------------------------------------------------------------------------------------------------------------------------------------------------------------------------------------------------------------------------------------------------------------------------------------------------------------------------------------------------------------------------------------------------------------------------------------------------------------------------------------------------------------|---------------------------------|-----|----|-----------|----|-----|-----|----|-----------|----|--------------------|-----------|----|-----------|----|------|-----|-----|-----------|----|------|------|------|-----------|-----|------|-----|----|-----------|------|------|------|-----|-----------|-----|------|------|------|-----------|----|-----|------|-----|-----------|------|------|------|----|-----|------|-----|----|------|------|------|----|-----|------|-----|----|------|------|------|----|-----|------|-----|----|------|------|------|----|-----|------|-----|----|------|------|------|----|-----|------|-----|----|------|------|------|----|-----|------|------|----|------|------|------|----|-----|------|------|----|------|------|------|----|-----|------|------|----|------|------|------|----|-----|------|------|----|------|------|------|----|------|------|------|----|------|------|------|----|------|------|------|----|------|------|------|
| <b>0.5mm Pitch Bottom Contact Type</b><br><br><b>0.5mm Pitch Top Contact Type</b> | <p>*Set the stiffener thickness to 0.188 (7.5mil) min.</p> <p style="text-align: center;">Unit : mm</p> <table border="1"> <thead> <tr> <th rowspan="2">Dimension<br/>Number of Contacts</th> <th colspan="2">A</th> <th colspan="2">B</th> </tr> <tr> <th>A</th> <th>B</th> <th>Number of Contacts</th> <th>Dimension</th> </tr> </thead> <tbody> <tr><td>6</td><td>2.5</td><td>3.5</td><td>25</td><td>12.0 13.0</td></tr> <tr><td>8</td><td>3.5</td><td>4.5</td><td>26</td><td>12.5 13.5</td></tr> <tr><td>10</td><td>4.5</td><td>5.5</td><td>28</td><td>13.5 14.5</td></tr> <tr><td>11</td><td>5.0</td><td>6.0</td><td>29</td><td>14.0 15.0</td></tr> <tr><td>12</td><td>5.5</td><td>6.5</td><td>30</td><td>14.5 15.5</td></tr> <tr><td>13</td><td>6.0</td><td>7.0</td><td>32</td><td>15.5 16.5</td></tr> <tr><td>14</td><td>6.5</td><td>7.5</td><td>33</td><td>16.0 17.0</td></tr> <tr><td>15</td><td>7.0</td><td>8.0</td><td>34</td><td>16.5 17.5</td></tr> <tr><td>16</td><td>7.5</td><td>8.5</td><td>35</td><td>17.0 18.0</td></tr> <tr><td>17</td><td>8.0</td><td>9.0</td><td>36</td><td>17.5 18.5</td></tr> <tr><td>18</td><td>8.5</td><td>9.5</td><td>40</td><td>19.5 20.5</td></tr> <tr><td>19</td><td>9.0</td><td>10.0</td><td>42</td><td>20.5 21.5</td></tr> <tr><td>20</td><td>9.5</td><td>10.5</td><td>45</td><td>22.0 23.0</td></tr> <tr><td>22</td><td>10.5</td><td>11.5</td><td>50</td><td>24.5 25.5</td></tr> <tr><td>24</td><td>11.5</td><td>12.5</td><td>53</td><td>26.0 27.0</td></tr> </tbody> </table> | Dimension<br>Number of Contacts | A                  |                    | B         |      | A    | B | Number of Contacts | Dimension | 6 | 2.5 | 3.5 | 25 | 12.0 13.0 | 8  | 3.5 | 4.5 | 26 | 12.5 13.5 | 10 | 4.5 | 5.5 | 28 | 13.5 14.5 | 11 | 5.0 | 6.0 | 29 | 14.0 15.0 | 12 | 5.5 | 6.5 | 30 | 14.5 15.5 | 13 | 6.0 | 7.0 | 32 | 15.5 16.5 | 14 | 6.5 | 7.5 | 33 | 16.0 17.0 | 15 | 7.0 | 8.0 | 34 | 16.5 17.5 | 16 | 7.5 | 8.5  | 35 | 17.0 18.0 | 17 | 8.0  | 9.0  | 36 | 17.5 18.5 | 18 | 8.5  | 9.5  | 40 | 19.5 20.5 | 19                                                                                                                                                                                                                                                                                                                                                                                                                                                                                                                                                                                                                                                                                                                                                                                                                                                                                                                                                                                                                                                                                                                                                                                               | 9.0                             | 10.0 | 42 | 20.5 21.5 | 20 | 9.5 | 10.5 | 45                 | 22.0 23.0 | 22 | 10.5 | 11.5 | 50 | 24.5 25.5 | 24 | 11.5 | 12.5 | 53 | 26.0 27.0 | <p style="text-align: center;">Recommended metal mask thickness : 0.15mm Unit : mm</p> <table border="1"> <thead> <tr> <th rowspan="2">Dimension<br/>Number of Contacts</th> <th colspan="3">A</th> <th colspan="3">B</th> </tr> <tr> <th>A</th> <th>B</th> <th>C</th> <th>Number of Contacts</th> <th>Dimension</th> <th>A</th> <th>B</th> <th>C</th> </tr> </thead> <tbody> <tr><td>6</td><td>2.5</td><td>8.1</td><td>4.5</td><td>25</td><td>12.0</td><td>17.6</td><td>14.0</td></tr> <tr><td>8</td><td>3.5</td><td>9.1</td><td>5.5</td><td>26</td><td>12.5</td><td>18.1</td><td>14.5</td></tr> <tr><td>10</td><td>4.5</td><td>10.1</td><td>6.5</td><td>28</td><td>13.5</td><td>19.1</td><td>15.5</td></tr> <tr><td>11</td><td>5.0</td><td>10.6</td><td>7.0</td><td>29</td><td>14.0</td><td>19.6</td><td>16.0</td></tr> <tr><td>12</td><td>5.5</td><td>11.1</td><td>7.5</td><td>30</td><td>14.5</td><td>20.1</td><td>16.5</td></tr> <tr><td>13</td><td>6.0</td><td>11.6</td><td>8.0</td><td>32</td><td>15.5</td><td>21.1</td><td>17.5</td></tr> <tr><td>14</td><td>6.5</td><td>12.1</td><td>8.5</td><td>33</td><td>16.0</td><td>21.6</td><td>18.0</td></tr> <tr><td>15</td><td>7.0</td><td>12.6</td><td>9.0</td><td>34</td><td>16.5</td><td>22.1</td><td>18.5</td></tr> <tr><td>16</td><td>7.5</td><td>13.1</td><td>9.5</td><td>35</td><td>17.0</td><td>22.6</td><td>19.0</td></tr> <tr><td>17</td><td>8.0</td><td>13.6</td><td>10.0</td><td>36</td><td>17.5</td><td>23.1</td><td>19.5</td></tr> <tr><td>18</td><td>8.5</td><td>14.1</td><td>10.5</td><td>40</td><td>19.5</td><td>25.1</td><td>21.5</td></tr> <tr><td>19</td><td>9.0</td><td>14.6</td><td>11.0</td><td>42</td><td>20.5</td><td>26.1</td><td>22.5</td></tr> <tr><td>20</td><td>9.5</td><td>15.1</td><td>11.5</td><td>45</td><td>22.0</td><td>27.6</td><td>24.0</td></tr> <tr><td>22</td><td>10.5</td><td>16.1</td><td>12.5</td><td>50</td><td>24.5</td><td>30.1</td><td>26.5</td></tr> <tr><td>24</td><td>11.5</td><td>17.1</td><td>13.5</td><td>53</td><td>26.0</td><td>31.6</td><td>28.0</td></tr> </tbody> </table> | Dimension<br>Number of Contacts | A   |    |           | B  |     |     | A  | B         | C  | Number of Contacts | Dimension | A  | B         | C  | 6    | 2.5 | 8.1 | 4.5       | 25 | 12.0 | 17.6 | 14.0 | 8         | 3.5 | 9.1  | 5.5 | 26 | 12.5      | 18.1 | 14.5 | 10   | 4.5 | 10.1      | 6.5 | 28   | 13.5 | 19.1 | 15.5      | 11 | 5.0 | 10.6 | 7.0 | 29        | 14.0 | 19.6 | 16.0 | 12 | 5.5 | 11.1 | 7.5 | 30 | 14.5 | 20.1 | 16.5 | 13 | 6.0 | 11.6 | 8.0 | 32 | 15.5 | 21.1 | 17.5 | 14 | 6.5 | 12.1 | 8.5 | 33 | 16.0 | 21.6 | 18.0 | 15 | 7.0 | 12.6 | 9.0 | 34 | 16.5 | 22.1 | 18.5 | 16 | 7.5 | 13.1 | 9.5 | 35 | 17.0 | 22.6 | 19.0 | 17 | 8.0 | 13.6 | 10.0 | 36 | 17.5 | 23.1 | 19.5 | 18 | 8.5 | 14.1 | 10.5 | 40 | 19.5 | 25.1 | 21.5 | 19 | 9.0 | 14.6 | 11.0 | 42 | 20.5 | 26.1 | 22.5 | 20 | 9.5 | 15.1 | 11.5 | 45 | 22.0 | 27.6 | 24.0 | 22 | 10.5 | 16.1 | 12.5 | 50 | 24.5 | 30.1 | 26.5 | 24 | 11.5 | 17.1 | 13.5 | 53 | 26.0 | 31.6 | 28.0 |
|                                                                                   | Dimension<br>Number of Contacts                                                                                                                                                                                                                                                                                                                                                                                                                                                                                                                                                                                                                                                                                                                                                                                                                                                                                                                                                                                                                                                                                                                                                                                                                                                                                                                                                                                                                                                                                                |                                 | A                  |                    | B         |      |      |   |                    |           |   |     |     |    |           |    |     |     |    |           |    |     |     |    |           |    |     |     |    |           |    |     |     |    |           |    |     |     |    |           |    |     |     |    |           |    |     |     |    |           |    |     |      |    |           |    |      |      |    |           |    |      |      |    |           |                                                                                                                                                                                                                                                                                                                                                                                                                                                                                                                                                                                                                                                                                                                                                                                                                                                                                                                                                                                                                                                                                                                                                                                                  |                                 |      |    |           |    |     |      |                    |           |    |      |      |    |           |    |      |      |    |           |                                                                                                                                                                                                                                                                                                                                                                                                                                                                                                                                                                                                                                                                                                                                                                                                                                                                                                                                                                                                                                                                                                                                                                                                                                                                                                                                                                                                                                                                                                                                                                                                                                                                                                                                                                                                                                                                                                                                                                                                                                                                                         |                                 |     |    |           |    |     |     |    |           |    |                    |           |    |           |    |      |     |     |           |    |      |      |      |           |     |      |     |    |           |      |      |      |     |           |     |      |      |      |           |    |     |      |     |           |      |      |      |    |     |      |     |    |      |      |      |    |     |      |     |    |      |      |      |    |     |      |     |    |      |      |      |    |     |      |     |    |      |      |      |    |     |      |     |    |      |      |      |    |     |      |      |    |      |      |      |    |     |      |      |    |      |      |      |    |     |      |      |    |      |      |      |    |     |      |      |    |      |      |      |    |      |      |      |    |      |      |      |    |      |      |      |    |      |      |      |
| A                                                                                 |                                                                                                                                                                                                                                                                                                                                                                                                                                                                                                                                                                                                                                                                                                                                                                                                                                                                                                                                                                                                                                                                                                                                                                                                                                                                                                                                                                                                                                                                                                                                | B                               | Number of Contacts | Dimension          |           |      |      |   |                    |           |   |     |     |    |           |    |     |     |    |           |    |     |     |    |           |    |     |     |    |           |    |     |     |    |           |    |     |     |    |           |    |     |     |    |           |    |     |     |    |           |    |     |      |    |           |    |      |      |    |           |    |      |      |    |           |                                                                                                                                                                                                                                                                                                                                                                                                                                                                                                                                                                                                                                                                                                                                                                                                                                                                                                                                                                                                                                                                                                                                                                                                  |                                 |      |    |           |    |     |      |                    |           |    |      |      |    |           |    |      |      |    |           |                                                                                                                                                                                                                                                                                                                                                                                                                                                                                                                                                                                                                                                                                                                                                                                                                                                                                                                                                                                                                                                                                                                                                                                                                                                                                                                                                                                                                                                                                                                                                                                                                                                                                                                                                                                                                                                                                                                                                                                                                                                                                         |                                 |     |    |           |    |     |     |    |           |    |                    |           |    |           |    |      |     |     |           |    |      |      |      |           |     |      |     |    |           |      |      |      |     |           |     |      |      |      |           |    |     |      |     |           |      |      |      |    |     |      |     |    |      |      |      |    |     |      |     |    |      |      |      |    |     |      |     |    |      |      |      |    |     |      |     |    |      |      |      |    |     |      |     |    |      |      |      |    |     |      |      |    |      |      |      |    |     |      |      |    |      |      |      |    |     |      |      |    |      |      |      |    |     |      |      |    |      |      |      |    |      |      |      |    |      |      |      |    |      |      |      |    |      |      |      |
| 6                                                                                 | 2.5                                                                                                                                                                                                                                                                                                                                                                                                                                                                                                                                                                                                                                                                                                                                                                                                                                                                                                                                                                                                                                                                                                                                                                                                                                                                                                                                                                                                                                                                                                                            | 3.5                             | 25                 | 12.0 13.0          |           |      |      |   |                    |           |   |     |     |    |           |    |     |     |    |           |    |     |     |    |           |    |     |     |    |           |    |     |     |    |           |    |     |     |    |           |    |     |     |    |           |    |     |     |    |           |    |     |      |    |           |    |      |      |    |           |    |      |      |    |           |                                                                                                                                                                                                                                                                                                                                                                                                                                                                                                                                                                                                                                                                                                                                                                                                                                                                                                                                                                                                                                                                                                                                                                                                  |                                 |      |    |           |    |     |      |                    |           |    |      |      |    |           |    |      |      |    |           |                                                                                                                                                                                                                                                                                                                                                                                                                                                                                                                                                                                                                                                                                                                                                                                                                                                                                                                                                                                                                                                                                                                                                                                                                                                                                                                                                                                                                                                                                                                                                                                                                                                                                                                                                                                                                                                                                                                                                                                                                                                                                         |                                 |     |    |           |    |     |     |    |           |    |                    |           |    |           |    |      |     |     |           |    |      |      |      |           |     |      |     |    |           |      |      |      |     |           |     |      |      |      |           |    |     |      |     |           |      |      |      |    |     |      |     |    |      |      |      |    |     |      |     |    |      |      |      |    |     |      |     |    |      |      |      |    |     |      |     |    |      |      |      |    |     |      |     |    |      |      |      |    |     |      |      |    |      |      |      |    |     |      |      |    |      |      |      |    |     |      |      |    |      |      |      |    |     |      |      |    |      |      |      |    |      |      |      |    |      |      |      |    |      |      |      |    |      |      |      |
| 8                                                                                 | 3.5                                                                                                                                                                                                                                                                                                                                                                                                                                                                                                                                                                                                                                                                                                                                                                                                                                                                                                                                                                                                                                                                                                                                                                                                                                                                                                                                                                                                                                                                                                                            | 4.5                             | 26                 | 12.5 13.5          |           |      |      |   |                    |           |   |     |     |    |           |    |     |     |    |           |    |     |     |    |           |    |     |     |    |           |    |     |     |    |           |    |     |     |    |           |    |     |     |    |           |    |     |     |    |           |    |     |      |    |           |    |      |      |    |           |    |      |      |    |           |                                                                                                                                                                                                                                                                                                                                                                                                                                                                                                                                                                                                                                                                                                                                                                                                                                                                                                                                                                                                                                                                                                                                                                                                  |                                 |      |    |           |    |     |      |                    |           |    |      |      |    |           |    |      |      |    |           |                                                                                                                                                                                                                                                                                                                                                                                                                                                                                                                                                                                                                                                                                                                                                                                                                                                                                                                                                                                                                                                                                                                                                                                                                                                                                                                                                                                                                                                                                                                                                                                                                                                                                                                                                                                                                                                                                                                                                                                                                                                                                         |                                 |     |    |           |    |     |     |    |           |    |                    |           |    |           |    |      |     |     |           |    |      |      |      |           |     |      |     |    |           |      |      |      |     |           |     |      |      |      |           |    |     |      |     |           |      |      |      |    |     |      |     |    |      |      |      |    |     |      |     |    |      |      |      |    |     |      |     |    |      |      |      |    |     |      |     |    |      |      |      |    |     |      |     |    |      |      |      |    |     |      |      |    |      |      |      |    |     |      |      |    |      |      |      |    |     |      |      |    |      |      |      |    |     |      |      |    |      |      |      |    |      |      |      |    |      |      |      |    |      |      |      |    |      |      |      |
| 10                                                                                | 4.5                                                                                                                                                                                                                                                                                                                                                                                                                                                                                                                                                                                                                                                                                                                                                                                                                                                                                                                                                                                                                                                                                                                                                                                                                                                                                                                                                                                                                                                                                                                            | 5.5                             | 28                 | 13.5 14.5          |           |      |      |   |                    |           |   |     |     |    |           |    |     |     |    |           |    |     |     |    |           |    |     |     |    |           |    |     |     |    |           |    |     |     |    |           |    |     |     |    |           |    |     |     |    |           |    |     |      |    |           |    |      |      |    |           |    |      |      |    |           |                                                                                                                                                                                                                                                                                                                                                                                                                                                                                                                                                                                                                                                                                                                                                                                                                                                                                                                                                                                                                                                                                                                                                                                                  |                                 |      |    |           |    |     |      |                    |           |    |      |      |    |           |    |      |      |    |           |                                                                                                                                                                                                                                                                                                                                                                                                                                                                                                                                                                                                                                                                                                                                                                                                                                                                                                                                                                                                                                                                                                                                                                                                                                                                                                                                                                                                                                                                                                                                                                                                                                                                                                                                                                                                                                                                                                                                                                                                                                                                                         |                                 |     |    |           |    |     |     |    |           |    |                    |           |    |           |    |      |     |     |           |    |      |      |      |           |     |      |     |    |           |      |      |      |     |           |     |      |      |      |           |    |     |      |     |           |      |      |      |    |     |      |     |    |      |      |      |    |     |      |     |    |      |      |      |    |     |      |     |    |      |      |      |    |     |      |     |    |      |      |      |    |     |      |     |    |      |      |      |    |     |      |      |    |      |      |      |    |     |      |      |    |      |      |      |    |     |      |      |    |      |      |      |    |     |      |      |    |      |      |      |    |      |      |      |    |      |      |      |    |      |      |      |    |      |      |      |
| 11                                                                                | 5.0                                                                                                                                                                                                                                                                                                                                                                                                                                                                                                                                                                                                                                                                                                                                                                                                                                                                                                                                                                                                                                                                                                                                                                                                                                                                                                                                                                                                                                                                                                                            | 6.0                             | 29                 | 14.0 15.0          |           |      |      |   |                    |           |   |     |     |    |           |    |     |     |    |           |    |     |     |    |           |    |     |     |    |           |    |     |     |    |           |    |     |     |    |           |    |     |     |    |           |    |     |     |    |           |    |     |      |    |           |    |      |      |    |           |    |      |      |    |           |                                                                                                                                                                                                                                                                                                                                                                                                                                                                                                                                                                                                                                                                                                                                                                                                                                                                                                                                                                                                                                                                                                                                                                                                  |                                 |      |    |           |    |     |      |                    |           |    |      |      |    |           |    |      |      |    |           |                                                                                                                                                                                                                                                                                                                                                                                                                                                                                                                                                                                                                                                                                                                                                                                                                                                                                                                                                                                                                                                                                                                                                                                                                                                                                                                                                                                                                                                                                                                                                                                                                                                                                                                                                                                                                                                                                                                                                                                                                                                                                         |                                 |     |    |           |    |     |     |    |           |    |                    |           |    |           |    |      |     |     |           |    |      |      |      |           |     |      |     |    |           |      |      |      |     |           |     |      |      |      |           |    |     |      |     |           |      |      |      |    |     |      |     |    |      |      |      |    |     |      |     |    |      |      |      |    |     |      |     |    |      |      |      |    |     |      |     |    |      |      |      |    |     |      |     |    |      |      |      |    |     |      |      |    |      |      |      |    |     |      |      |    |      |      |      |    |     |      |      |    |      |      |      |    |     |      |      |    |      |      |      |    |      |      |      |    |      |      |      |    |      |      |      |    |      |      |      |
| 12                                                                                | 5.5                                                                                                                                                                                                                                                                                                                                                                                                                                                                                                                                                                                                                                                                                                                                                                                                                                                                                                                                                                                                                                                                                                                                                                                                                                                                                                                                                                                                                                                                                                                            | 6.5                             | 30                 | 14.5 15.5          |           |      |      |   |                    |           |   |     |     |    |           |    |     |     |    |           |    |     |     |    |           |    |     |     |    |           |    |     |     |    |           |    |     |     |    |           |    |     |     |    |           |    |     |     |    |           |    |     |      |    |           |    |      |      |    |           |    |      |      |    |           |                                                                                                                                                                                                                                                                                                                                                                                                                                                                                                                                                                                                                                                                                                                                                                                                                                                                                                                                                                                                                                                                                                                                                                                                  |                                 |      |    |           |    |     |      |                    |           |    |      |      |    |           |    |      |      |    |           |                                                                                                                                                                                                                                                                                                                                                                                                                                                                                                                                                                                                                                                                                                                                                                                                                                                                                                                                                                                                                                                                                                                                                                                                                                                                                                                                                                                                                                                                                                                                                                                                                                                                                                                                                                                                                                                                                                                                                                                                                                                                                         |                                 |     |    |           |    |     |     |    |           |    |                    |           |    |           |    |      |     |     |           |    |      |      |      |           |     |      |     |    |           |      |      |      |     |           |     |      |      |      |           |    |     |      |     |           |      |      |      |    |     |      |     |    |      |      |      |    |     |      |     |    |      |      |      |    |     |      |     |    |      |      |      |    |     |      |     |    |      |      |      |    |     |      |     |    |      |      |      |    |     |      |      |    |      |      |      |    |     |      |      |    |      |      |      |    |     |      |      |    |      |      |      |    |     |      |      |    |      |      |      |    |      |      |      |    |      |      |      |    |      |      |      |    |      |      |      |
| 13                                                                                | 6.0                                                                                                                                                                                                                                                                                                                                                                                                                                                                                                                                                                                                                                                                                                                                                                                                                                                                                                                                                                                                                                                                                                                                                                                                                                                                                                                                                                                                                                                                                                                            | 7.0                             | 32                 | 15.5 16.5          |           |      |      |   |                    |           |   |     |     |    |           |    |     |     |    |           |    |     |     |    |           |    |     |     |    |           |    |     |     |    |           |    |     |     |    |           |    |     |     |    |           |    |     |     |    |           |    |     |      |    |           |    |      |      |    |           |    |      |      |    |           |                                                                                                                                                                                                                                                                                                                                                                                                                                                                                                                                                                                                                                                                                                                                                                                                                                                                                                                                                                                                                                                                                                                                                                                                  |                                 |      |    |           |    |     |      |                    |           |    |      |      |    |           |    |      |      |    |           |                                                                                                                                                                                                                                                                                                                                                                                                                                                                                                                                                                                                                                                                                                                                                                                                                                                                                                                                                                                                                                                                                                                                                                                                                                                                                                                                                                                                                                                                                                                                                                                                                                                                                                                                                                                                                                                                                                                                                                                                                                                                                         |                                 |     |    |           |    |     |     |    |           |    |                    |           |    |           |    |      |     |     |           |    |      |      |      |           |     |      |     |    |           |      |      |      |     |           |     |      |      |      |           |    |     |      |     |           |      |      |      |    |     |      |     |    |      |      |      |    |     |      |     |    |      |      |      |    |     |      |     |    |      |      |      |    |     |      |     |    |      |      |      |    |     |      |     |    |      |      |      |    |     |      |      |    |      |      |      |    |     |      |      |    |      |      |      |    |     |      |      |    |      |      |      |    |     |      |      |    |      |      |      |    |      |      |      |    |      |      |      |    |      |      |      |    |      |      |      |
| 14                                                                                | 6.5                                                                                                                                                                                                                                                                                                                                                                                                                                                                                                                                                                                                                                                                                                                                                                                                                                                                                                                                                                                                                                                                                                                                                                                                                                                                                                                                                                                                                                                                                                                            | 7.5                             | 33                 | 16.0 17.0          |           |      |      |   |                    |           |   |     |     |    |           |    |     |     |    |           |    |     |     |    |           |    |     |     |    |           |    |     |     |    |           |    |     |     |    |           |    |     |     |    |           |    |     |     |    |           |    |     |      |    |           |    |      |      |    |           |    |      |      |    |           |                                                                                                                                                                                                                                                                                                                                                                                                                                                                                                                                                                                                                                                                                                                                                                                                                                                                                                                                                                                                                                                                                                                                                                                                  |                                 |      |    |           |    |     |      |                    |           |    |      |      |    |           |    |      |      |    |           |                                                                                                                                                                                                                                                                                                                                                                                                                                                                                                                                                                                                                                                                                                                                                                                                                                                                                                                                                                                                                                                                                                                                                                                                                                                                                                                                                                                                                                                                                                                                                                                                                                                                                                                                                                                                                                                                                                                                                                                                                                                                                         |                                 |     |    |           |    |     |     |    |           |    |                    |           |    |           |    |      |     |     |           |    |      |      |      |           |     |      |     |    |           |      |      |      |     |           |     |      |      |      |           |    |     |      |     |           |      |      |      |    |     |      |     |    |      |      |      |    |     |      |     |    |      |      |      |    |     |      |     |    |      |      |      |    |     |      |     |    |      |      |      |    |     |      |     |    |      |      |      |    |     |      |      |    |      |      |      |    |     |      |      |    |      |      |      |    |     |      |      |    |      |      |      |    |     |      |      |    |      |      |      |    |      |      |      |    |      |      |      |    |      |      |      |    |      |      |      |
| 15                                                                                | 7.0                                                                                                                                                                                                                                                                                                                                                                                                                                                                                                                                                                                                                                                                                                                                                                                                                                                                                                                                                                                                                                                                                                                                                                                                                                                                                                                                                                                                                                                                                                                            | 8.0                             | 34                 | 16.5 17.5          |           |      |      |   |                    |           |   |     |     |    |           |    |     |     |    |           |    |     |     |    |           |    |     |     |    |           |    |     |     |    |           |    |     |     |    |           |    |     |     |    |           |    |     |     |    |           |    |     |      |    |           |    |      |      |    |           |    |      |      |    |           |                                                                                                                                                                                                                                                                                                                                                                                                                                                                                                                                                                                                                                                                                                                                                                                                                                                                                                                                                                                                                                                                                                                                                                                                  |                                 |      |    |           |    |     |      |                    |           |    |      |      |    |           |    |      |      |    |           |                                                                                                                                                                                                                                                                                                                                                                                                                                                                                                                                                                                                                                                                                                                                                                                                                                                                                                                                                                                                                                                                                                                                                                                                                                                                                                                                                                                                                                                                                                                                                                                                                                                                                                                                                                                                                                                                                                                                                                                                                                                                                         |                                 |     |    |           |    |     |     |    |           |    |                    |           |    |           |    |      |     |     |           |    |      |      |      |           |     |      |     |    |           |      |      |      |     |           |     |      |      |      |           |    |     |      |     |           |      |      |      |    |     |      |     |    |      |      |      |    |     |      |     |    |      |      |      |    |     |      |     |    |      |      |      |    |     |      |     |    |      |      |      |    |     |      |     |    |      |      |      |    |     |      |      |    |      |      |      |    |     |      |      |    |      |      |      |    |     |      |      |    |      |      |      |    |     |      |      |    |      |      |      |    |      |      |      |    |      |      |      |    |      |      |      |    |      |      |      |
| 16                                                                                | 7.5                                                                                                                                                                                                                                                                                                                                                                                                                                                                                                                                                                                                                                                                                                                                                                                                                                                                                                                                                                                                                                                                                                                                                                                                                                                                                                                                                                                                                                                                                                                            | 8.5                             | 35                 | 17.0 18.0          |           |      |      |   |                    |           |   |     |     |    |           |    |     |     |    |           |    |     |     |    |           |    |     |     |    |           |    |     |     |    |           |    |     |     |    |           |    |     |     |    |           |    |     |     |    |           |    |     |      |    |           |    |      |      |    |           |    |      |      |    |           |                                                                                                                                                                                                                                                                                                                                                                                                                                                                                                                                                                                                                                                                                                                                                                                                                                                                                                                                                                                                                                                                                                                                                                                                  |                                 |      |    |           |    |     |      |                    |           |    |      |      |    |           |    |      |      |    |           |                                                                                                                                                                                                                                                                                                                                                                                                                                                                                                                                                                                                                                                                                                                                                                                                                                                                                                                                                                                                                                                                                                                                                                                                                                                                                                                                                                                                                                                                                                                                                                                                                                                                                                                                                                                                                                                                                                                                                                                                                                                                                         |                                 |     |    |           |    |     |     |    |           |    |                    |           |    |           |    |      |     |     |           |    |      |      |      |           |     |      |     |    |           |      |      |      |     |           |     |      |      |      |           |    |     |      |     |           |      |      |      |    |     |      |     |    |      |      |      |    |     |      |     |    |      |      |      |    |     |      |     |    |      |      |      |    |     |      |     |    |      |      |      |    |     |      |     |    |      |      |      |    |     |      |      |    |      |      |      |    |     |      |      |    |      |      |      |    |     |      |      |    |      |      |      |    |     |      |      |    |      |      |      |    |      |      |      |    |      |      |      |    |      |      |      |    |      |      |      |
| 17                                                                                | 8.0                                                                                                                                                                                                                                                                                                                                                                                                                                                                                                                                                                                                                                                                                                                                                                                                                                                                                                                                                                                                                                                                                                                                                                                                                                                                                                                                                                                                                                                                                                                            | 9.0                             | 36                 | 17.5 18.5          |           |      |      |   |                    |           |   |     |     |    |           |    |     |     |    |           |    |     |     |    |           |    |     |     |    |           |    |     |     |    |           |    |     |     |    |           |    |     |     |    |           |    |     |     |    |           |    |     |      |    |           |    |      |      |    |           |    |      |      |    |           |                                                                                                                                                                                                                                                                                                                                                                                                                                                                                                                                                                                                                                                                                                                                                                                                                                                                                                                                                                                                                                                                                                                                                                                                  |                                 |      |    |           |    |     |      |                    |           |    |      |      |    |           |    |      |      |    |           |                                                                                                                                                                                                                                                                                                                                                                                                                                                                                                                                                                                                                                                                                                                                                                                                                                                                                                                                                                                                                                                                                                                                                                                                                                                                                                                                                                                                                                                                                                                                                                                                                                                                                                                                                                                                                                                                                                                                                                                                                                                                                         |                                 |     |    |           |    |     |     |    |           |    |                    |           |    |           |    |      |     |     |           |    |      |      |      |           |     |      |     |    |           |      |      |      |     |           |     |      |      |      |           |    |     |      |     |           |      |      |      |    |     |      |     |    |      |      |      |    |     |      |     |    |      |      |      |    |     |      |     |    |      |      |      |    |     |      |     |    |      |      |      |    |     |      |     |    |      |      |      |    |     |      |      |    |      |      |      |    |     |      |      |    |      |      |      |    |     |      |      |    |      |      |      |    |     |      |      |    |      |      |      |    |      |      |      |    |      |      |      |    |      |      |      |    |      |      |      |
| 18                                                                                | 8.5                                                                                                                                                                                                                                                                                                                                                                                                                                                                                                                                                                                                                                                                                                                                                                                                                                                                                                                                                                                                                                                                                                                                                                                                                                                                                                                                                                                                                                                                                                                            | 9.5                             | 40                 | 19.5 20.5          |           |      |      |   |                    |           |   |     |     |    |           |    |     |     |    |           |    |     |     |    |           |    |     |     |    |           |    |     |     |    |           |    |     |     |    |           |    |     |     |    |           |    |     |     |    |           |    |     |      |    |           |    |      |      |    |           |    |      |      |    |           |                                                                                                                                                                                                                                                                                                                                                                                                                                                                                                                                                                                                                                                                                                                                                                                                                                                                                                                                                                                                                                                                                                                                                                                                  |                                 |      |    |           |    |     |      |                    |           |    |      |      |    |           |    |      |      |    |           |                                                                                                                                                                                                                                                                                                                                                                                                                                                                                                                                                                                                                                                                                                                                                                                                                                                                                                                                                                                                                                                                                                                                                                                                                                                                                                                                                                                                                                                                                                                                                                                                                                                                                                                                                                                                                                                                                                                                                                                                                                                                                         |                                 |     |    |           |    |     |     |    |           |    |                    |           |    |           |    |      |     |     |           |    |      |      |      |           |     |      |     |    |           |      |      |      |     |           |     |      |      |      |           |    |     |      |     |           |      |      |      |    |     |      |     |    |      |      |      |    |     |      |     |    |      |      |      |    |     |      |     |    |      |      |      |    |     |      |     |    |      |      |      |    |     |      |     |    |      |      |      |    |     |      |      |    |      |      |      |    |     |      |      |    |      |      |      |    |     |      |      |    |      |      |      |    |     |      |      |    |      |      |      |    |      |      |      |    |      |      |      |    |      |      |      |    |      |      |      |
| 19                                                                                | 9.0                                                                                                                                                                                                                                                                                                                                                                                                                                                                                                                                                                                                                                                                                                                                                                                                                                                                                                                                                                                                                                                                                                                                                                                                                                                                                                                                                                                                                                                                                                                            | 10.0                            | 42                 | 20.5 21.5          |           |      |      |   |                    |           |   |     |     |    |           |    |     |     |    |           |    |     |     |    |           |    |     |     |    |           |    |     |     |    |           |    |     |     |    |           |    |     |     |    |           |    |     |     |    |           |    |     |      |    |           |    |      |      |    |           |    |      |      |    |           |                                                                                                                                                                                                                                                                                                                                                                                                                                                                                                                                                                                                                                                                                                                                                                                                                                                                                                                                                                                                                                                                                                                                                                                                  |                                 |      |    |           |    |     |      |                    |           |    |      |      |    |           |    |      |      |    |           |                                                                                                                                                                                                                                                                                                                                                                                                                                                                                                                                                                                                                                                                                                                                                                                                                                                                                                                                                                                                                                                                                                                                                                                                                                                                                                                                                                                                                                                                                                                                                                                                                                                                                                                                                                                                                                                                                                                                                                                                                                                                                         |                                 |     |    |           |    |     |     |    |           |    |                    |           |    |           |    |      |     |     |           |    |      |      |      |           |     |      |     |    |           |      |      |      |     |           |     |      |      |      |           |    |     |      |     |           |      |      |      |    |     |      |     |    |      |      |      |    |     |      |     |    |      |      |      |    |     |      |     |    |      |      |      |    |     |      |     |    |      |      |      |    |     |      |     |    |      |      |      |    |     |      |      |    |      |      |      |    |     |      |      |    |      |      |      |    |     |      |      |    |      |      |      |    |     |      |      |    |      |      |      |    |      |      |      |    |      |      |      |    |      |      |      |    |      |      |      |
| 20                                                                                | 9.5                                                                                                                                                                                                                                                                                                                                                                                                                                                                                                                                                                                                                                                                                                                                                                                                                                                                                                                                                                                                                                                                                                                                                                                                                                                                                                                                                                                                                                                                                                                            | 10.5                            | 45                 | 22.0 23.0          |           |      |      |   |                    |           |   |     |     |    |           |    |     |     |    |           |    |     |     |    |           |    |     |     |    |           |    |     |     |    |           |    |     |     |    |           |    |     |     |    |           |    |     |     |    |           |    |     |      |    |           |    |      |      |    |           |    |      |      |    |           |                                                                                                                                                                                                                                                                                                                                                                                                                                                                                                                                                                                                                                                                                                                                                                                                                                                                                                                                                                                                                                                                                                                                                                                                  |                                 |      |    |           |    |     |      |                    |           |    |      |      |    |           |    |      |      |    |           |                                                                                                                                                                                                                                                                                                                                                                                                                                                                                                                                                                                                                                                                                                                                                                                                                                                                                                                                                                                                                                                                                                                                                                                                                                                                                                                                                                                                                                                                                                                                                                                                                                                                                                                                                                                                                                                                                                                                                                                                                                                                                         |                                 |     |    |           |    |     |     |    |           |    |                    |           |    |           |    |      |     |     |           |    |      |      |      |           |     |      |     |    |           |      |      |      |     |           |     |      |      |      |           |    |     |      |     |           |      |      |      |    |     |      |     |    |      |      |      |    |     |      |     |    |      |      |      |    |     |      |     |    |      |      |      |    |     |      |     |    |      |      |      |    |     |      |     |    |      |      |      |    |     |      |      |    |      |      |      |    |     |      |      |    |      |      |      |    |     |      |      |    |      |      |      |    |     |      |      |    |      |      |      |    |      |      |      |    |      |      |      |    |      |      |      |    |      |      |      |
| 22                                                                                | 10.5                                                                                                                                                                                                                                                                                                                                                                                                                                                                                                                                                                                                                                                                                                                                                                                                                                                                                                                                                                                                                                                                                                                                                                                                                                                                                                                                                                                                                                                                                                                           | 11.5                            | 50                 | 24.5 25.5          |           |      |      |   |                    |           |   |     |     |    |           |    |     |     |    |           |    |     |     |    |           |    |     |     |    |           |    |     |     |    |           |    |     |     |    |           |    |     |     |    |           |    |     |     |    |           |    |     |      |    |           |    |      |      |    |           |    |      |      |    |           |                                                                                                                                                                                                                                                                                                                                                                                                                                                                                                                                                                                                                                                                                                                                                                                                                                                                                                                                                                                                                                                                                                                                                                                                  |                                 |      |    |           |    |     |      |                    |           |    |      |      |    |           |    |      |      |    |           |                                                                                                                                                                                                                                                                                                                                                                                                                                                                                                                                                                                                                                                                                                                                                                                                                                                                                                                                                                                                                                                                                                                                                                                                                                                                                                                                                                                                                                                                                                                                                                                                                                                                                                                                                                                                                                                                                                                                                                                                                                                                                         |                                 |     |    |           |    |     |     |    |           |    |                    |           |    |           |    |      |     |     |           |    |      |      |      |           |     |      |     |    |           |      |      |      |     |           |     |      |      |      |           |    |     |      |     |           |      |      |      |    |     |      |     |    |      |      |      |    |     |      |     |    |      |      |      |    |     |      |     |    |      |      |      |    |     |      |     |    |      |      |      |    |     |      |     |    |      |      |      |    |     |      |      |    |      |      |      |    |     |      |      |    |      |      |      |    |     |      |      |    |      |      |      |    |     |      |      |    |      |      |      |    |      |      |      |    |      |      |      |    |      |      |      |    |      |      |      |
| 24                                                                                | 11.5                                                                                                                                                                                                                                                                                                                                                                                                                                                                                                                                                                                                                                                                                                                                                                                                                                                                                                                                                                                                                                                                                                                                                                                                                                                                                                                                                                                                                                                                                                                           | 12.5                            | 53                 | 26.0 27.0          |           |      |      |   |                    |           |   |     |     |    |           |    |     |     |    |           |    |     |     |    |           |    |     |     |    |           |    |     |     |    |           |    |     |     |    |           |    |     |     |    |           |    |     |     |    |           |    |     |      |    |           |    |      |      |    |           |    |      |      |    |           |                                                                                                                                                                                                                                                                                                                                                                                                                                                                                                                                                                                                                                                                                                                                                                                                                                                                                                                                                                                                                                                                                                                                                                                                  |                                 |      |    |           |    |     |      |                    |           |    |      |      |    |           |    |      |      |    |           |                                                                                                                                                                                                                                                                                                                                                                                                                                                                                                                                                                                                                                                                                                                                                                                                                                                                                                                                                                                                                                                                                                                                                                                                                                                                                                                                                                                                                                                                                                                                                                                                                                                                                                                                                                                                                                                                                                                                                                                                                                                                                         |                                 |     |    |           |    |     |     |    |           |    |                    |           |    |           |    |      |     |     |           |    |      |      |      |           |     |      |     |    |           |      |      |      |     |           |     |      |      |      |           |    |     |      |     |           |      |      |      |    |     |      |     |    |      |      |      |    |     |      |     |    |      |      |      |    |     |      |     |    |      |      |      |    |     |      |     |    |      |      |      |    |     |      |     |    |      |      |      |    |     |      |      |    |      |      |      |    |     |      |      |    |      |      |      |    |     |      |      |    |      |      |      |    |     |      |      |    |      |      |      |    |      |      |      |    |      |      |      |    |      |      |      |    |      |      |      |
| Dimension<br>Number of Contacts                                                   | A                                                                                                                                                                                                                                                                                                                                                                                                                                                                                                                                                                                                                                                                                                                                                                                                                                                                                                                                                                                                                                                                                                                                                                                                                                                                                                                                                                                                                                                                                                                              |                                 |                    | B                  |           |      |      |   |                    |           |   |     |     |    |           |    |     |     |    |           |    |     |     |    |           |    |     |     |    |           |    |     |     |    |           |    |     |     |    |           |    |     |     |    |           |    |     |     |    |           |    |     |      |    |           |    |      |      |    |           |    |      |      |    |           |                                                                                                                                                                                                                                                                                                                                                                                                                                                                                                                                                                                                                                                                                                                                                                                                                                                                                                                                                                                                                                                                                                                                                                                                  |                                 |      |    |           |    |     |      |                    |           |    |      |      |    |           |    |      |      |    |           |                                                                                                                                                                                                                                                                                                                                                                                                                                                                                                                                                                                                                                                                                                                                                                                                                                                                                                                                                                                                                                                                                                                                                                                                                                                                                                                                                                                                                                                                                                                                                                                                                                                                                                                                                                                                                                                                                                                                                                                                                                                                                         |                                 |     |    |           |    |     |     |    |           |    |                    |           |    |           |    |      |     |     |           |    |      |      |      |           |     |      |     |    |           |      |      |      |     |           |     |      |      |      |           |    |     |      |     |           |      |      |      |    |     |      |     |    |      |      |      |    |     |      |     |    |      |      |      |    |     |      |     |    |      |      |      |    |     |      |     |    |      |      |      |    |     |      |     |    |      |      |      |    |     |      |      |    |      |      |      |    |     |      |      |    |      |      |      |    |     |      |      |    |      |      |      |    |     |      |      |    |      |      |      |    |      |      |      |    |      |      |      |    |      |      |      |    |      |      |      |
|                                                                                   | A                                                                                                                                                                                                                                                                                                                                                                                                                                                                                                                                                                                                                                                                                                                                                                                                                                                                                                                                                                                                                                                                                                                                                                                                                                                                                                                                                                                                                                                                                                                              | B                               | C                  | Number of Contacts | Dimension | A    | B    | C |                    |           |   |     |     |    |           |    |     |     |    |           |    |     |     |    |           |    |     |     |    |           |    |     |     |    |           |    |     |     |    |           |    |     |     |    |           |    |     |     |    |           |    |     |      |    |           |    |      |      |    |           |    |      |      |    |           |                                                                                                                                                                                                                                                                                                                                                                                                                                                                                                                                                                                                                                                                                                                                                                                                                                                                                                                                                                                                                                                                                                                                                                                                  |                                 |      |    |           |    |     |      |                    |           |    |      |      |    |           |    |      |      |    |           |                                                                                                                                                                                                                                                                                                                                                                                                                                                                                                                                                                                                                                                                                                                                                                                                                                                                                                                                                                                                                                                                                                                                                                                                                                                                                                                                                                                                                                                                                                                                                                                                                                                                                                                                                                                                                                                                                                                                                                                                                                                                                         |                                 |     |    |           |    |     |     |    |           |    |                    |           |    |           |    |      |     |     |           |    |      |      |      |           |     |      |     |    |           |      |      |      |     |           |     |      |      |      |           |    |     |      |     |           |      |      |      |    |     |      |     |    |      |      |      |    |     |      |     |    |      |      |      |    |     |      |     |    |      |      |      |    |     |      |     |    |      |      |      |    |     |      |     |    |      |      |      |    |     |      |      |    |      |      |      |    |     |      |      |    |      |      |      |    |     |      |      |    |      |      |      |    |     |      |      |    |      |      |      |    |      |      |      |    |      |      |      |    |      |      |      |    |      |      |      |
| 6                                                                                 | 2.5                                                                                                                                                                                                                                                                                                                                                                                                                                                                                                                                                                                                                                                                                                                                                                                                                                                                                                                                                                                                                                                                                                                                                                                                                                                                                                                                                                                                                                                                                                                            | 8.1                             | 4.5                | 25                 | 12.0      | 17.6 | 14.0 |   |                    |           |   |     |     |    |           |    |     |     |    |           |    |     |     |    |           |    |     |     |    |           |    |     |     |    |           |    |     |     |    |           |    |     |     |    |           |    |     |     |    |           |    |     |      |    |           |    |      |      |    |           |    |      |      |    |           |                                                                                                                                                                                                                                                                                                                                                                                                                                                                                                                                                                                                                                                                                                                                                                                                                                                                                                                                                                                                                                                                                                                                                                                                  |                                 |      |    |           |    |     |      |                    |           |    |      |      |    |           |    |      |      |    |           |                                                                                                                                                                                                                                                                                                                                                                                                                                                                                                                                                                                                                                                                                                                                                                                                                                                                                                                                                                                                                                                                                                                                                                                                                                                                                                                                                                                                                                                                                                                                                                                                                                                                                                                                                                                                                                                                                                                                                                                                                                                                                         |                                 |     |    |           |    |     |     |    |           |    |                    |           |    |           |    |      |     |     |           |    |      |      |      |           |     |      |     |    |           |      |      |      |     |           |     |      |      |      |           |    |     |      |     |           |      |      |      |    |     |      |     |    |      |      |      |    |     |      |     |    |      |      |      |    |     |      |     |    |      |      |      |    |     |      |     |    |      |      |      |    |     |      |     |    |      |      |      |    |     |      |      |    |      |      |      |    |     |      |      |    |      |      |      |    |     |      |      |    |      |      |      |    |     |      |      |    |      |      |      |    |      |      |      |    |      |      |      |    |      |      |      |    |      |      |      |
| 8                                                                                 | 3.5                                                                                                                                                                                                                                                                                                                                                                                                                                                                                                                                                                                                                                                                                                                                                                                                                                                                                                                                                                                                                                                                                                                                                                                                                                                                                                                                                                                                                                                                                                                            | 9.1                             | 5.5                | 26                 | 12.5      | 18.1 | 14.5 |   |                    |           |   |     |     |    |           |    |     |     |    |           |    |     |     |    |           |    |     |     |    |           |    |     |     |    |           |    |     |     |    |           |    |     |     |    |           |    |     |     |    |           |    |     |      |    |           |    |      |      |    |           |    |      |      |    |           |                                                                                                                                                                                                                                                                                                                                                                                                                                                                                                                                                                                                                                                                                                                                                                                                                                                                                                                                                                                                                                                                                                                                                                                                  |                                 |      |    |           |    |     |      |                    |           |    |      |      |    |           |    |      |      |    |           |                                                                                                                                                                                                                                                                                                                                                                                                                                                                                                                                                                                                                                                                                                                                                                                                                                                                                                                                                                                                                                                                                                                                                                                                                                                                                                                                                                                                                                                                                                                                                                                                                                                                                                                                                                                                                                                                                                                                                                                                                                                                                         |                                 |     |    |           |    |     |     |    |           |    |                    |           |    |           |    |      |     |     |           |    |      |      |      |           |     |      |     |    |           |      |      |      |     |           |     |      |      |      |           |    |     |      |     |           |      |      |      |    |     |      |     |    |      |      |      |    |     |      |     |    |      |      |      |    |     |      |     |    |      |      |      |    |     |      |     |    |      |      |      |    |     |      |     |    |      |      |      |    |     |      |      |    |      |      |      |    |     |      |      |    |      |      |      |    |     |      |      |    |      |      |      |    |     |      |      |    |      |      |      |    |      |      |      |    |      |      |      |    |      |      |      |    |      |      |      |
| 10                                                                                | 4.5                                                                                                                                                                                                                                                                                                                                                                                                                                                                                                                                                                                                                                                                                                                                                                                                                                                                                                                                                                                                                                                                                                                                                                                                                                                                                                                                                                                                                                                                                                                            | 10.1                            | 6.5                | 28                 | 13.5      | 19.1 | 15.5 |   |                    |           |   |     |     |    |           |    |     |     |    |           |    |     |     |    |           |    |     |     |    |           |    |     |     |    |           |    |     |     |    |           |    |     |     |    |           |    |     |     |    |           |    |     |      |    |           |    |      |      |    |           |    |      |      |    |           |                                                                                                                                                                                                                                                                                                                                                                                                                                                                                                                                                                                                                                                                                                                                                                                                                                                                                                                                                                                                                                                                                                                                                                                                  |                                 |      |    |           |    |     |      |                    |           |    |      |      |    |           |    |      |      |    |           |                                                                                                                                                                                                                                                                                                                                                                                                                                                                                                                                                                                                                                                                                                                                                                                                                                                                                                                                                                                                                                                                                                                                                                                                                                                                                                                                                                                                                                                                                                                                                                                                                                                                                                                                                                                                                                                                                                                                                                                                                                                                                         |                                 |     |    |           |    |     |     |    |           |    |                    |           |    |           |    |      |     |     |           |    |      |      |      |           |     |      |     |    |           |      |      |      |     |           |     |      |      |      |           |    |     |      |     |           |      |      |      |    |     |      |     |    |      |      |      |    |     |      |     |    |      |      |      |    |     |      |     |    |      |      |      |    |     |      |     |    |      |      |      |    |     |      |     |    |      |      |      |    |     |      |      |    |      |      |      |    |     |      |      |    |      |      |      |    |     |      |      |    |      |      |      |    |     |      |      |    |      |      |      |    |      |      |      |    |      |      |      |    |      |      |      |    |      |      |      |
| 11                                                                                | 5.0                                                                                                                                                                                                                                                                                                                                                                                                                                                                                                                                                                                                                                                                                                                                                                                                                                                                                                                                                                                                                                                                                                                                                                                                                                                                                                                                                                                                                                                                                                                            | 10.6                            | 7.0                | 29                 | 14.0      | 19.6 | 16.0 |   |                    |           |   |     |     |    |           |    |     |     |    |           |    |     |     |    |           |    |     |     |    |           |    |     |     |    |           |    |     |     |    |           |    |     |     |    |           |    |     |     |    |           |    |     |      |    |           |    |      |      |    |           |    |      |      |    |           |                                                                                                                                                                                                                                                                                                                                                                                                                                                                                                                                                                                                                                                                                                                                                                                                                                                                                                                                                                                                                                                                                                                                                                                                  |                                 |      |    |           |    |     |      |                    |           |    |      |      |    |           |    |      |      |    |           |                                                                                                                                                                                                                                                                                                                                                                                                                                                                                                                                                                                                                                                                                                                                                                                                                                                                                                                                                                                                                                                                                                                                                                                                                                                                                                                                                                                                                                                                                                                                                                                                                                                                                                                                                                                                                                                                                                                                                                                                                                                                                         |                                 |     |    |           |    |     |     |    |           |    |                    |           |    |           |    |      |     |     |           |    |      |      |      |           |     |      |     |    |           |      |      |      |     |           |     |      |      |      |           |    |     |      |     |           |      |      |      |    |     |      |     |    |      |      |      |    |     |      |     |    |      |      |      |    |     |      |     |    |      |      |      |    |     |      |     |    |      |      |      |    |     |      |     |    |      |      |      |    |     |      |      |    |      |      |      |    |     |      |      |    |      |      |      |    |     |      |      |    |      |      |      |    |     |      |      |    |      |      |      |    |      |      |      |    |      |      |      |    |      |      |      |    |      |      |      |
| 12                                                                                | 5.5                                                                                                                                                                                                                                                                                                                                                                                                                                                                                                                                                                                                                                                                                                                                                                                                                                                                                                                                                                                                                                                                                                                                                                                                                                                                                                                                                                                                                                                                                                                            | 11.1                            | 7.5                | 30                 | 14.5      | 20.1 | 16.5 |   |                    |           |   |     |     |    |           |    |     |     |    |           |    |     |     |    |           |    |     |     |    |           |    |     |     |    |           |    |     |     |    |           |    |     |     |    |           |    |     |     |    |           |    |     |      |    |           |    |      |      |    |           |    |      |      |    |           |                                                                                                                                                                                                                                                                                                                                                                                                                                                                                                                                                                                                                                                                                                                                                                                                                                                                                                                                                                                                                                                                                                                                                                                                  |                                 |      |    |           |    |     |      |                    |           |    |      |      |    |           |    |      |      |    |           |                                                                                                                                                                                                                                                                                                                                                                                                                                                                                                                                                                                                                                                                                                                                                                                                                                                                                                                                                                                                                                                                                                                                                                                                                                                                                                                                                                                                                                                                                                                                                                                                                                                                                                                                                                                                                                                                                                                                                                                                                                                                                         |                                 |     |    |           |    |     |     |    |           |    |                    |           |    |           |    |      |     |     |           |    |      |      |      |           |     |      |     |    |           |      |      |      |     |           |     |      |      |      |           |    |     |      |     |           |      |      |      |    |     |      |     |    |      |      |      |    |     |      |     |    |      |      |      |    |     |      |     |    |      |      |      |    |     |      |     |    |      |      |      |    |     |      |     |    |      |      |      |    |     |      |      |    |      |      |      |    |     |      |      |    |      |      |      |    |     |      |      |    |      |      |      |    |     |      |      |    |      |      |      |    |      |      |      |    |      |      |      |    |      |      |      |    |      |      |      |
| 13                                                                                | 6.0                                                                                                                                                                                                                                                                                                                                                                                                                                                                                                                                                                                                                                                                                                                                                                                                                                                                                                                                                                                                                                                                                                                                                                                                                                                                                                                                                                                                                                                                                                                            | 11.6                            | 8.0                | 32                 | 15.5      | 21.1 | 17.5 |   |                    |           |   |     |     |    |           |    |     |     |    |           |    |     |     |    |           |    |     |     |    |           |    |     |     |    |           |    |     |     |    |           |    |     |     |    |           |    |     |     |    |           |    |     |      |    |           |    |      |      |    |           |    |      |      |    |           |                                                                                                                                                                                                                                                                                                                                                                                                                                                                                                                                                                                                                                                                                                                                                                                                                                                                                                                                                                                                                                                                                                                                                                                                  |                                 |      |    |           |    |     |      |                    |           |    |      |      |    |           |    |      |      |    |           |                                                                                                                                                                                                                                                                                                                                                                                                                                                                                                                                                                                                                                                                                                                                                                                                                                                                                                                                                                                                                                                                                                                                                                                                                                                                                                                                                                                                                                                                                                                                                                                                                                                                                                                                                                                                                                                                                                                                                                                                                                                                                         |                                 |     |    |           |    |     |     |    |           |    |                    |           |    |           |    |      |     |     |           |    |      |      |      |           |     |      |     |    |           |      |      |      |     |           |     |      |      |      |           |    |     |      |     |           |      |      |      |    |     |      |     |    |      |      |      |    |     |      |     |    |      |      |      |    |     |      |     |    |      |      |      |    |     |      |     |    |      |      |      |    |     |      |     |    |      |      |      |    |     |      |      |    |      |      |      |    |     |      |      |    |      |      |      |    |     |      |      |    |      |      |      |    |     |      |      |    |      |      |      |    |      |      |      |    |      |      |      |    |      |      |      |    |      |      |      |
| 14                                                                                | 6.5                                                                                                                                                                                                                                                                                                                                                                                                                                                                                                                                                                                                                                                                                                                                                                                                                                                                                                                                                                                                                                                                                                                                                                                                                                                                                                                                                                                                                                                                                                                            | 12.1                            | 8.5                | 33                 | 16.0      | 21.6 | 18.0 |   |                    |           |   |     |     |    |           |    |     |     |    |           |    |     |     |    |           |    |     |     |    |           |    |     |     |    |           |    |     |     |    |           |    |     |     |    |           |    |     |     |    |           |    |     |      |    |           |    |      |      |    |           |    |      |      |    |           |                                                                                                                                                                                                                                                                                                                                                                                                                                                                                                                                                                                                                                                                                                                                                                                                                                                                                                                                                                                                                                                                                                                                                                                                  |                                 |      |    |           |    |     |      |                    |           |    |      |      |    |           |    |      |      |    |           |                                                                                                                                                                                                                                                                                                                                                                                                                                                                                                                                                                                                                                                                                                                                                                                                                                                                                                                                                                                                                                                                                                                                                                                                                                                                                                                                                                                                                                                                                                                                                                                                                                                                                                                                                                                                                                                                                                                                                                                                                                                                                         |                                 |     |    |           |    |     |     |    |           |    |                    |           |    |           |    |      |     |     |           |    |      |      |      |           |     |      |     |    |           |      |      |      |     |           |     |      |      |      |           |    |     |      |     |           |      |      |      |    |     |      |     |    |      |      |      |    |     |      |     |    |      |      |      |    |     |      |     |    |      |      |      |    |     |      |     |    |      |      |      |    |     |      |     |    |      |      |      |    |     |      |      |    |      |      |      |    |     |      |      |    |      |      |      |    |     |      |      |    |      |      |      |    |     |      |      |    |      |      |      |    |      |      |      |    |      |      |      |    |      |      |      |    |      |      |      |
| 15                                                                                | 7.0                                                                                                                                                                                                                                                                                                                                                                                                                                                                                                                                                                                                                                                                                                                                                                                                                                                                                                                                                                                                                                                                                                                                                                                                                                                                                                                                                                                                                                                                                                                            | 12.6                            | 9.0                | 34                 | 16.5      | 22.1 | 18.5 |   |                    |           |   |     |     |    |           |    |     |     |    |           |    |     |     |    |           |    |     |     |    |           |    |     |     |    |           |    |     |     |    |           |    |     |     |    |           |    |     |     |    |           |    |     |      |    |           |    |      |      |    |           |    |      |      |    |           |                                                                                                                                                                                                                                                                                                                                                                                                                                                                                                                                                                                                                                                                                                                                                                                                                                                                                                                                                                                                                                                                                                                                                                                                  |                                 |      |    |           |    |     |      |                    |           |    |      |      |    |           |    |      |      |    |           |                                                                                                                                                                                                                                                                                                                                                                                                                                                                                                                                                                                                                                                                                                                                                                                                                                                                                                                                                                                                                                                                                                                                                                                                                                                                                                                                                                                                                                                                                                                                                                                                                                                                                                                                                                                                                                                                                                                                                                                                                                                                                         |                                 |     |    |           |    |     |     |    |           |    |                    |           |    |           |    |      |     |     |           |    |      |      |      |           |     |      |     |    |           |      |      |      |     |           |     |      |      |      |           |    |     |      |     |           |      |      |      |    |     |      |     |    |      |      |      |    |     |      |     |    |      |      |      |    |     |      |     |    |      |      |      |    |     |      |     |    |      |      |      |    |     |      |     |    |      |      |      |    |     |      |      |    |      |      |      |    |     |      |      |    |      |      |      |    |     |      |      |    |      |      |      |    |     |      |      |    |      |      |      |    |      |      |      |    |      |      |      |    |      |      |      |    |      |      |      |
| 16                                                                                | 7.5                                                                                                                                                                                                                                                                                                                                                                                                                                                                                                                                                                                                                                                                                                                                                                                                                                                                                                                                                                                                                                                                                                                                                                                                                                                                                                                                                                                                                                                                                                                            | 13.1                            | 9.5                | 35                 | 17.0      | 22.6 | 19.0 |   |                    |           |   |     |     |    |           |    |     |     |    |           |    |     |     |    |           |    |     |     |    |           |    |     |     |    |           |    |     |     |    |           |    |     |     |    |           |    |     |     |    |           |    |     |      |    |           |    |      |      |    |           |    |      |      |    |           |                                                                                                                                                                                                                                                                                                                                                                                                                                                                                                                                                                                                                                                                                                                                                                                                                                                                                                                                                                                                                                                                                                                                                                                                  |                                 |      |    |           |    |     |      |                    |           |    |      |      |    |           |    |      |      |    |           |                                                                                                                                                                                                                                                                                                                                                                                                                                                                                                                                                                                                                                                                                                                                                                                                                                                                                                                                                                                                                                                                                                                                                                                                                                                                                                                                                                                                                                                                                                                                                                                                                                                                                                                                                                                                                                                                                                                                                                                                                                                                                         |                                 |     |    |           |    |     |     |    |           |    |                    |           |    |           |    |      |     |     |           |    |      |      |      |           |     |      |     |    |           |      |      |      |     |           |     |      |      |      |           |    |     |      |     |           |      |      |      |    |     |      |     |    |      |      |      |    |     |      |     |    |      |      |      |    |     |      |     |    |      |      |      |    |     |      |     |    |      |      |      |    |     |      |     |    |      |      |      |    |     |      |      |    |      |      |      |    |     |      |      |    |      |      |      |    |     |      |      |    |      |      |      |    |     |      |      |    |      |      |      |    |      |      |      |    |      |      |      |    |      |      |      |    |      |      |      |
| 17                                                                                | 8.0                                                                                                                                                                                                                                                                                                                                                                                                                                                                                                                                                                                                                                                                                                                                                                                                                                                                                                                                                                                                                                                                                                                                                                                                                                                                                                                                                                                                                                                                                                                            | 13.6                            | 10.0               | 36                 | 17.5      | 23.1 | 19.5 |   |                    |           |   |     |     |    |           |    |     |     |    |           |    |     |     |    |           |    |     |     |    |           |    |     |     |    |           |    |     |     |    |           |    |     |     |    |           |    |     |     |    |           |    |     |      |    |           |    |      |      |    |           |    |      |      |    |           |                                                                                                                                                                                                                                                                                                                                                                                                                                                                                                                                                                                                                                                                                                                                                                                                                                                                                                                                                                                                                                                                                                                                                                                                  |                                 |      |    |           |    |     |      |                    |           |    |      |      |    |           |    |      |      |    |           |                                                                                                                                                                                                                                                                                                                                                                                                                                                                                                                                                                                                                                                                                                                                                                                                                                                                                                                                                                                                                                                                                                                                                                                                                                                                                                                                                                                                                                                                                                                                                                                                                                                                                                                                                                                                                                                                                                                                                                                                                                                                                         |                                 |     |    |           |    |     |     |    |           |    |                    |           |    |           |    |      |     |     |           |    |      |      |      |           |     |      |     |    |           |      |      |      |     |           |     |      |      |      |           |    |     |      |     |           |      |      |      |    |     |      |     |    |      |      |      |    |     |      |     |    |      |      |      |    |     |      |     |    |      |      |      |    |     |      |     |    |      |      |      |    |     |      |     |    |      |      |      |    |     |      |      |    |      |      |      |    |     |      |      |    |      |      |      |    |     |      |      |    |      |      |      |    |     |      |      |    |      |      |      |    |      |      |      |    |      |      |      |    |      |      |      |    |      |      |      |
| 18                                                                                | 8.5                                                                                                                                                                                                                                                                                                                                                                                                                                                                                                                                                                                                                                                                                                                                                                                                                                                                                                                                                                                                                                                                                                                                                                                                                                                                                                                                                                                                                                                                                                                            | 14.1                            | 10.5               | 40                 | 19.5      | 25.1 | 21.5 |   |                    |           |   |     |     |    |           |    |     |     |    |           |    |     |     |    |           |    |     |     |    |           |    |     |     |    |           |    |     |     |    |           |    |     |     |    |           |    |     |     |    |           |    |     |      |    |           |    |      |      |    |           |    |      |      |    |           |                                                                                                                                                                                                                                                                                                                                                                                                                                                                                                                                                                                                                                                                                                                                                                                                                                                                                                                                                                                                                                                                                                                                                                                                  |                                 |      |    |           |    |     |      |                    |           |    |      |      |    |           |    |      |      |    |           |                                                                                                                                                                                                                                                                                                                                                                                                                                                                                                                                                                                                                                                                                                                                                                                                                                                                                                                                                                                                                                                                                                                                                                                                                                                                                                                                                                                                                                                                                                                                                                                                                                                                                                                                                                                                                                                                                                                                                                                                                                                                                         |                                 |     |    |           |    |     |     |    |           |    |                    |           |    |           |    |      |     |     |           |    |      |      |      |           |     |      |     |    |           |      |      |      |     |           |     |      |      |      |           |    |     |      |     |           |      |      |      |    |     |      |     |    |      |      |      |    |     |      |     |    |      |      |      |    |     |      |     |    |      |      |      |    |     |      |     |    |      |      |      |    |     |      |     |    |      |      |      |    |     |      |      |    |      |      |      |    |     |      |      |    |      |      |      |    |     |      |      |    |      |      |      |    |     |      |      |    |      |      |      |    |      |      |      |    |      |      |      |    |      |      |      |    |      |      |      |
| 19                                                                                | 9.0                                                                                                                                                                                                                                                                                                                                                                                                                                                                                                                                                                                                                                                                                                                                                                                                                                                                                                                                                                                                                                                                                                                                                                                                                                                                                                                                                                                                                                                                                                                            | 14.6                            | 11.0               | 42                 | 20.5      | 26.1 | 22.5 |   |                    |           |   |     |     |    |           |    |     |     |    |           |    |     |     |    |           |    |     |     |    |           |    |     |     |    |           |    |     |     |    |           |    |     |     |    |           |    |     |     |    |           |    |     |      |    |           |    |      |      |    |           |    |      |      |    |           |                                                                                                                                                                                                                                                                                                                                                                                                                                                                                                                                                                                                                                                                                                                                                                                                                                                                                                                                                                                                                                                                                                                                                                                                  |                                 |      |    |           |    |     |      |                    |           |    |      |      |    |           |    |      |      |    |           |                                                                                                                                                                                                                                                                                                                                                                                                                                                                                                                                                                                                                                                                                                                                                                                                                                                                                                                                                                                                                                                                                                                                                                                                                                                                                                                                                                                                                                                                                                                                                                                                                                                                                                                                                                                                                                                                                                                                                                                                                                                                                         |                                 |     |    |           |    |     |     |    |           |    |                    |           |    |           |    |      |     |     |           |    |      |      |      |           |     |      |     |    |           |      |      |      |     |           |     |      |      |      |           |    |     |      |     |           |      |      |      |    |     |      |     |    |      |      |      |    |     |      |     |    |      |      |      |    |     |      |     |    |      |      |      |    |     |      |     |    |      |      |      |    |     |      |     |    |      |      |      |    |     |      |      |    |      |      |      |    |     |      |      |    |      |      |      |    |     |      |      |    |      |      |      |    |     |      |      |    |      |      |      |    |      |      |      |    |      |      |      |    |      |      |      |    |      |      |      |
| 20                                                                                | 9.5                                                                                                                                                                                                                                                                                                                                                                                                                                                                                                                                                                                                                                                                                                                                                                                                                                                                                                                                                                                                                                                                                                                                                                                                                                                                                                                                                                                                                                                                                                                            | 15.1                            | 11.5               | 45                 | 22.0      | 27.6 | 24.0 |   |                    |           |   |     |     |    |           |    |     |     |    |           |    |     |     |    |           |    |     |     |    |           |    |     |     |    |           |    |     |     |    |           |    |     |     |    |           |    |     |     |    |           |    |     |      |    |           |    |      |      |    |           |    |      |      |    |           |                                                                                                                                                                                                                                                                                                                                                                                                                                                                                                                                                                                                                                                                                                                                                                                                                                                                                                                                                                                                                                                                                                                                                                                                  |                                 |      |    |           |    |     |      |                    |           |    |      |      |    |           |    |      |      |    |           |                                                                                                                                                                                                                                                                                                                                                                                                                                                                                                                                                                                                                                                                                                                                                                                                                                                                                                                                                                                                                                                                                                                                                                                                                                                                                                                                                                                                                                                                                                                                                                                                                                                                                                                                                                                                                                                                                                                                                                                                                                                                                         |                                 |     |    |           |    |     |     |    |           |    |                    |           |    |           |    |      |     |     |           |    |      |      |      |           |     |      |     |    |           |      |      |      |     |           |     |      |      |      |           |    |     |      |     |           |      |      |      |    |     |      |     |    |      |      |      |    |     |      |     |    |      |      |      |    |     |      |     |    |      |      |      |    |     |      |     |    |      |      |      |    |     |      |     |    |      |      |      |    |     |      |      |    |      |      |      |    |     |      |      |    |      |      |      |    |     |      |      |    |      |      |      |    |     |      |      |    |      |      |      |    |      |      |      |    |      |      |      |    |      |      |      |    |      |      |      |
| 22                                                                                | 10.5                                                                                                                                                                                                                                                                                                                                                                                                                                                                                                                                                                                                                                                                                                                                                                                                                                                                                                                                                                                                                                                                                                                                                                                                                                                                                                                                                                                                                                                                                                                           | 16.1                            | 12.5               | 50                 | 24.5      | 30.1 | 26.5 |   |                    |           |   |     |     |    |           |    |     |     |    |           |    |     |     |    |           |    |     |     |    |           |    |     |     |    |           |    |     |     |    |           |    |     |     |    |           |    |     |     |    |           |    |     |      |    |           |    |      |      |    |           |    |      |      |    |           |                                                                                                                                                                                                                                                                                                                                                                                                                                                                                                                                                                                                                                                                                                                                                                                                                                                                                                                                                                                                                                                                                                                                                                                                  |                                 |      |    |           |    |     |      |                    |           |    |      |      |    |           |    |      |      |    |           |                                                                                                                                                                                                                                                                                                                                                                                                                                                                                                                                                                                                                                                                                                                                                                                                                                                                                                                                                                                                                                                                                                                                                                                                                                                                                                                                                                                                                                                                                                                                                                                                                                                                                                                                                                                                                                                                                                                                                                                                                                                                                         |                                 |     |    |           |    |     |     |    |           |    |                    |           |    |           |    |      |     |     |           |    |      |      |      |           |     |      |     |    |           |      |      |      |     |           |     |      |      |      |           |    |     |      |     |           |      |      |      |    |     |      |     |    |      |      |      |    |     |      |     |    |      |      |      |    |     |      |     |    |      |      |      |    |     |      |     |    |      |      |      |    |     |      |     |    |      |      |      |    |     |      |      |    |      |      |      |    |     |      |      |    |      |      |      |    |     |      |      |    |      |      |      |    |     |      |      |    |      |      |      |    |      |      |      |    |      |      |      |    |      |      |      |    |      |      |      |
| 24                                                                                | 11.5                                                                                                                                                                                                                                                                                                                                                                                                                                                                                                                                                                                                                                                                                                                                                                                                                                                                                                                                                                                                                                                                                                                                                                                                                                                                                                                                                                                                                                                                                                                           | 17.1                            | 13.5               | 53                 | 26.0      | 31.6 | 28.0 |   |                    |           |   |     |     |    |           |    |     |     |    |           |    |     |     |    |           |    |     |     |    |           |    |     |     |    |           |    |     |     |    |           |    |     |     |    |           |    |     |     |    |           |    |     |      |    |           |    |      |      |    |           |    |      |      |    |           |                                                                                                                                                                                                                                                                                                                                                                                                                                                                                                                                                                                                                                                                                                                                                                                                                                                                                                                                                                                                                                                                                                                                                                                                  |                                 |      |    |           |    |     |      |                    |           |    |      |      |    |           |    |      |      |    |           |                                                                                                                                                                                                                                                                                                                                                                                                                                                                                                                                                                                                                                                                                                                                                                                                                                                                                                                                                                                                                                                                                                                                                                                                                                                                                                                                                                                                                                                                                                                                                                                                                                                                                                                                                                                                                                                                                                                                                                                                                                                                                         |                                 |     |    |           |    |     |     |    |           |    |                    |           |    |           |    |      |     |     |           |    |      |      |      |           |     |      |     |    |           |      |      |      |     |           |     |      |      |      |           |    |     |      |     |           |      |      |      |    |     |      |     |    |      |      |      |    |     |      |     |    |      |      |      |    |     |      |     |    |      |      |      |    |     |      |     |    |      |      |      |    |     |      |     |    |      |      |      |    |     |      |      |    |      |      |      |    |     |      |      |    |      |      |      |    |     |      |      |    |      |      |      |    |     |      |      |    |      |      |      |    |      |      |      |    |      |      |      |    |      |      |      |    |      |      |      |
| <b>0.5mm Pitch Vertical Mounting Type</b>                                         | <p>*Set the stiffener thickness to 0.188 (7.5mil) min.</p> <p style="text-align: center;">Unit : mm</p> <table border="1"> <thead> <tr> <th rowspan="2">Dimension<br/>Number of Contacts</th> <th colspan="2">A</th> <th colspan="2">B</th> </tr> <tr> <th>A</th> <th>B</th> <th>Number of Contacts</th> <th>Dimension</th> </tr> </thead> <tbody> <tr><td>6</td><td>2.5</td><td>3.5</td><td>26</td><td>12.5 13.5</td></tr> <tr><td>10</td><td>4.5</td><td>5.5</td><td>30</td><td>14.5 15.5</td></tr> <tr><td>12</td><td>5.5</td><td>6.5</td><td>32</td><td>15.5 16.5</td></tr> <tr><td>13</td><td>6.0</td><td>7.0</td><td>33</td><td>16.0 17.0</td></tr> <tr><td>15</td><td>7.0</td><td>8.0</td><td>34</td><td>16.5 17.5</td></tr> <tr><td>16</td><td>7.5</td><td>8.5</td><td>36</td><td>17.5 18.5</td></tr> <tr><td>17</td><td>8.0</td><td>9.0</td><td>40</td><td>19.5 20.5</td></tr> <tr><td>18</td><td>8.5</td><td>9.5</td><td>45</td><td>22.0 23.0</td></tr> <tr><td>20</td><td>9.5</td><td>10.5</td><td>49</td><td>24.0 25.0</td></tr> <tr><td>22</td><td>10.5</td><td>11.5</td><td>50</td><td>24.5 25.5</td></tr> <tr><td>24</td><td>11.5</td><td>12.5</td><td>60</td><td>29.5 30.5</td></tr> </tbody> </table>                                                                                                                                                                                                                                                                                                         | Dimension<br>Number of Contacts | A                  |                    | B         |      | A    | B | Number of Contacts | Dimension | 6 | 2.5 | 3.5 | 26 | 12.5 13.5 | 10 | 4.5 | 5.5 | 30 | 14.5 15.5 | 12 | 5.5 | 6.5 | 32 | 15.5 16.5 | 13 | 6.0 | 7.0 | 33 | 16.0 17.0 | 15 | 7.0 | 8.0 | 34 | 16.5 17.5 | 16 | 7.5 | 8.5 | 36 | 17.5 18.5 | 17 | 8.0 | 9.0 | 40 | 19.5 20.5 | 18 | 8.5 | 9.5 | 45 | 22.0 23.0 | 20 | 9.5 | 10.5 | 49 | 24.0 25.0 | 22 | 10.5 | 11.5 | 50 | 24.5 25.5 | 24 | 11.5 | 12.5 | 60 | 29.5 30.5 | <p style="text-align: center;">Recommended metal mask thickness : 0.15mm Unit : mm</p> <table border="1"> <thead> <tr> <th rowspan="2">Dimension<br/>Number of Contacts</th> <th colspan="2">A</th> <th colspan="2">B</th> </tr> <tr> <th>A</th> <th>B</th> <th>Number of Contacts</th> <th>Dimension</th> </tr> </thead> <tbody> <tr><td>10</td><td>6.5</td><td>4.5</td><td>26</td><td>14.5 12.5</td></tr> <tr><td>12</td><td>7.5</td><td>5.5</td><td>30</td><td>16.5 14.5</td></tr> <tr><td>13</td><td>8.0</td><td>6.0</td><td>32</td><td>17.5 15.5</td></tr> <tr><td>15</td><td>9.0</td><td>7.0</td><td>33</td><td>18.0 16.0</td></tr> <tr><td>16</td><td>9.5</td><td>7.5</td><td>34</td><td>18.5 16.5</td></tr> <tr><td>17</td><td>10.0</td><td>8.0</td><td>36</td><td>19.5 17.5</td></tr> <tr><td>18</td><td>10.5</td><td>8.5</td><td>40</td><td>21.5 19.5</td></tr> <tr><td>20</td><td>11.5</td><td>9.5</td><td>45</td><td>24.0 22.0</td></tr> <tr><td>22</td><td>12.5</td><td>10.5</td><td>49</td><td>26.0 24.0</td></tr> <tr><td>24</td><td>13.5</td><td>11.5</td><td>50</td><td>26.5 24.5</td></tr> <tr><td></td><td></td><td></td><td>60</td><td>31.5 29.5</td></tr> </tbody> </table> | Dimension<br>Number of Contacts | A    |    | B         |    | A   | B    | Number of Contacts | Dimension | 10 | 6.5  | 4.5  | 26 | 14.5 12.5 | 12 | 7.5  | 5.5  | 30 | 16.5 14.5 | 13                                                                                                                                                                                                                                                                                                                                                                                                                                                                                                                                                                                                                                                                                                                                                                                                                                                                                                                                                                                                                                                                                                                                                                                                                                                                                                                                                                                                                                                                                                                                                                                                                                                                                                                                                                                                                                                                                                                                                                                                                                                                                      | 8.0                             | 6.0 | 32 | 17.5 15.5 | 15 | 9.0 | 7.0 | 33 | 18.0 16.0 | 16 | 9.5                | 7.5       | 34 | 18.5 16.5 | 17 | 10.0 | 8.0 | 36  | 19.5 17.5 | 18 | 10.5 | 8.5  | 40   | 21.5 19.5 | 20  | 11.5 | 9.5 | 45 | 24.0 22.0 | 22   | 12.5 | 10.5 | 49  | 26.0 24.0 | 24  | 13.5 | 11.5 | 50   | 26.5 24.5 |    |     |      | 60  | 31.5 29.5 |      |      |      |    |     |      |     |    |      |      |      |    |     |      |     |    |      |      |      |    |     |      |     |    |      |      |      |    |     |      |     |    |      |      |      |    |     |      |     |    |      |      |      |    |     |      |      |    |      |      |      |    |     |      |      |    |      |      |      |    |     |      |      |    |      |      |      |    |     |      |      |    |      |      |      |    |      |      |      |    |      |      |      |    |      |      |      |    |      |      |      |
|                                                                                   | Dimension<br>Number of Contacts                                                                                                                                                                                                                                                                                                                                                                                                                                                                                                                                                                                                                                                                                                                                                                                                                                                                                                                                                                                                                                                                                                                                                                                                                                                                                                                                                                                                                                                                                                |                                 | A                  |                    | B         |      |      |   |                    |           |   |     |     |    |           |    |     |     |    |           |    |     |     |    |           |    |     |     |    |           |    |     |     |    |           |    |     |     |    |           |    |     |     |    |           |    |     |     |    |           |    |     |      |    |           |    |      |      |    |           |    |      |      |    |           |                                                                                                                                                                                                                                                                                                                                                                                                                                                                                                                                                                                                                                                                                                                                                                                                                                                                                                                                                                                                                                                                                                                                                                                                  |                                 |      |    |           |    |     |      |                    |           |    |      |      |    |           |    |      |      |    |           |                                                                                                                                                                                                                                                                                                                                                                                                                                                                                                                                                                                                                                                                                                                                                                                                                                                                                                                                                                                                                                                                                                                                                                                                                                                                                                                                                                                                                                                                                                                                                                                                                                                                                                                                                                                                                                                                                                                                                                                                                                                                                         |                                 |     |    |           |    |     |     |    |           |    |                    |           |    |           |    |      |     |     |           |    |      |      |      |           |     |      |     |    |           |      |      |      |     |           |     |      |      |      |           |    |     |      |     |           |      |      |      |    |     |      |     |    |      |      |      |    |     |      |     |    |      |      |      |    |     |      |     |    |      |      |      |    |     |      |     |    |      |      |      |    |     |      |     |    |      |      |      |    |     |      |      |    |      |      |      |    |     |      |      |    |      |      |      |    |     |      |      |    |      |      |      |    |     |      |      |    |      |      |      |    |      |      |      |    |      |      |      |    |      |      |      |    |      |      |      |
| A                                                                                 |                                                                                                                                                                                                                                                                                                                                                                                                                                                                                                                                                                                                                                                                                                                                                                                                                                                                                                                                                                                                                                                                                                                                                                                                                                                                                                                                                                                                                                                                                                                                | B                               | Number of Contacts | Dimension          |           |      |      |   |                    |           |   |     |     |    |           |    |     |     |    |           |    |     |     |    |           |    |     |     |    |           |    |     |     |    |           |    |     |     |    |           |    |     |     |    |           |    |     |     |    |           |    |     |      |    |           |    |      |      |    |           |    |      |      |    |           |                                                                                                                                                                                                                                                                                                                                                                                                                                                                                                                                                                                                                                                                                                                                                                                                                                                                                                                                                                                                                                                                                                                                                                                                  |                                 |      |    |           |    |     |      |                    |           |    |      |      |    |           |    |      |      |    |           |                                                                                                                                                                                                                                                                                                                                                                                                                                                                                                                                                                                                                                                                                                                                                                                                                                                                                                                                                                                                                                                                                                                                                                                                                                                                                                                                                                                                                                                                                                                                                                                                                                                                                                                                                                                                                                                                                                                                                                                                                                                                                         |                                 |     |    |           |    |     |     |    |           |    |                    |           |    |           |    |      |     |     |           |    |      |      |      |           |     |      |     |    |           |      |      |      |     |           |     |      |      |      |           |    |     |      |     |           |      |      |      |    |     |      |     |    |      |      |      |    |     |      |     |    |      |      |      |    |     |      |     |    |      |      |      |    |     |      |     |    |      |      |      |    |     |      |     |    |      |      |      |    |     |      |      |    |      |      |      |    |     |      |      |    |      |      |      |    |     |      |      |    |      |      |      |    |     |      |      |    |      |      |      |    |      |      |      |    |      |      |      |    |      |      |      |    |      |      |      |
| 6                                                                                 | 2.5                                                                                                                                                                                                                                                                                                                                                                                                                                                                                                                                                                                                                                                                                                                                                                                                                                                                                                                                                                                                                                                                                                                                                                                                                                                                                                                                                                                                                                                                                                                            | 3.5                             | 26                 | 12.5 13.5          |           |      |      |   |                    |           |   |     |     |    |           |    |     |     |    |           |    |     |     |    |           |    |     |     |    |           |    |     |     |    |           |    |     |     |    |           |    |     |     |    |           |    |     |     |    |           |    |     |      |    |           |    |      |      |    |           |    |      |      |    |           |                                                                                                                                                                                                                                                                                                                                                                                                                                                                                                                                                                                                                                                                                                                                                                                                                                                                                                                                                                                                                                                                                                                                                                                                  |                                 |      |    |           |    |     |      |                    |           |    |      |      |    |           |    |      |      |    |           |                                                                                                                                                                                                                                                                                                                                                                                                                                                                                                                                                                                                                                                                                                                                                                                                                                                                                                                                                                                                                                                                                                                                                                                                                                                                                                                                                                                                                                                                                                                                                                                                                                                                                                                                                                                                                                                                                                                                                                                                                                                                                         |                                 |     |    |           |    |     |     |    |           |    |                    |           |    |           |    |      |     |     |           |    |      |      |      |           |     |      |     |    |           |      |      |      |     |           |     |      |      |      |           |    |     |      |     |           |      |      |      |    |     |      |     |    |      |      |      |    |     |      |     |    |      |      |      |    |     |      |     |    |      |      |      |    |     |      |     |    |      |      |      |    |     |      |     |    |      |      |      |    |     |      |      |    |      |      |      |    |     |      |      |    |      |      |      |    |     |      |      |    |      |      |      |    |     |      |      |    |      |      |      |    |      |      |      |    |      |      |      |    |      |      |      |    |      |      |      |
| 10                                                                                | 4.5                                                                                                                                                                                                                                                                                                                                                                                                                                                                                                                                                                                                                                                                                                                                                                                                                                                                                                                                                                                                                                                                                                                                                                                                                                                                                                                                                                                                                                                                                                                            | 5.5                             | 30                 | 14.5 15.5          |           |      |      |   |                    |           |   |     |     |    |           |    |     |     |    |           |    |     |     |    |           |    |     |     |    |           |    |     |     |    |           |    |     |     |    |           |    |     |     |    |           |    |     |     |    |           |    |     |      |    |           |    |      |      |    |           |    |      |      |    |           |                                                                                                                                                                                                                                                                                                                                                                                                                                                                                                                                                                                                                                                                                                                                                                                                                                                                                                                                                                                                                                                                                                                                                                                                  |                                 |      |    |           |    |     |      |                    |           |    |      |      |    |           |    |      |      |    |           |                                                                                                                                                                                                                                                                                                                                                                                                                                                                                                                                                                                                                                                                                                                                                                                                                                                                                                                                                                                                                                                                                                                                                                                                                                                                                                                                                                                                                                                                                                                                                                                                                                                                                                                                                                                                                                                                                                                                                                                                                                                                                         |                                 |     |    |           |    |     |     |    |           |    |                    |           |    |           |    |      |     |     |           |    |      |      |      |           |     |      |     |    |           |      |      |      |     |           |     |      |      |      |           |    |     |      |     |           |      |      |      |    |     |      |     |    |      |      |      |    |     |      |     |    |      |      |      |    |     |      |     |    |      |      |      |    |     |      |     |    |      |      |      |    |     |      |     |    |      |      |      |    |     |      |      |    |      |      |      |    |     |      |      |    |      |      |      |    |     |      |      |    |      |      |      |    |     |      |      |    |      |      |      |    |      |      |      |    |      |      |      |    |      |      |      |    |      |      |      |
| 12                                                                                | 5.5                                                                                                                                                                                                                                                                                                                                                                                                                                                                                                                                                                                                                                                                                                                                                                                                                                                                                                                                                                                                                                                                                                                                                                                                                                                                                                                                                                                                                                                                                                                            | 6.5                             | 32                 | 15.5 16.5          |           |      |      |   |                    |           |   |     |     |    |           |    |     |     |    |           |    |     |     |    |           |    |     |     |    |           |    |     |     |    |           |    |     |     |    |           |    |     |     |    |           |    |     |     |    |           |    |     |      |    |           |    |      |      |    |           |    |      |      |    |           |                                                                                                                                                                                                                                                                                                                                                                                                                                                                                                                                                                                                                                                                                                                                                                                                                                                                                                                                                                                                                                                                                                                                                                                                  |                                 |      |    |           |    |     |      |                    |           |    |      |      |    |           |    |      |      |    |           |                                                                                                                                                                                                                                                                                                                                                                                                                                                                                                                                                                                                                                                                                                                                                                                                                                                                                                                                                                                                                                                                                                                                                                                                                                                                                                                                                                                                                                                                                                                                                                                                                                                                                                                                                                                                                                                                                                                                                                                                                                                                                         |                                 |     |    |           |    |     |     |    |           |    |                    |           |    |           |    |      |     |     |           |    |      |      |      |           |     |      |     |    |           |      |      |      |     |           |     |      |      |      |           |    |     |      |     |           |      |      |      |    |     |      |     |    |      |      |      |    |     |      |     |    |      |      |      |    |     |      |     |    |      |      |      |    |     |      |     |    |      |      |      |    |     |      |     |    |      |      |      |    |     |      |      |    |      |      |      |    |     |      |      |    |      |      |      |    |     |      |      |    |      |      |      |    |     |      |      |    |      |      |      |    |      |      |      |    |      |      |      |    |      |      |      |    |      |      |      |
| 13                                                                                | 6.0                                                                                                                                                                                                                                                                                                                                                                                                                                                                                                                                                                                                                                                                                                                                                                                                                                                                                                                                                                                                                                                                                                                                                                                                                                                                                                                                                                                                                                                                                                                            | 7.0                             | 33                 | 16.0 17.0          |           |      |      |   |                    |           |   |     |     |    |           |    |     |     |    |           |    |     |     |    |           |    |     |     |    |           |    |     |     |    |           |    |     |     |    |           |    |     |     |    |           |    |     |     |    |           |    |     |      |    |           |    |      |      |    |           |    |      |      |    |           |                                                                                                                                                                                                                                                                                                                                                                                                                                                                                                                                                                                                                                                                                                                                                                                                                                                                                                                                                                                                                                                                                                                                                                                                  |                                 |      |    |           |    |     |      |                    |           |    |      |      |    |           |    |      |      |    |           |                                                                                                                                                                                                                                                                                                                                                                                                                                                                                                                                                                                                                                                                                                                                                                                                                                                                                                                                                                                                                                                                                                                                                                                                                                                                                                                                                                                                                                                                                                                                                                                                                                                                                                                                                                                                                                                                                                                                                                                                                                                                                         |                                 |     |    |           |    |     |     |    |           |    |                    |           |    |           |    |      |     |     |           |    |      |      |      |           |     |      |     |    |           |      |      |      |     |           |     |      |      |      |           |    |     |      |     |           |      |      |      |    |     |      |     |    |      |      |      |    |     |      |     |    |      |      |      |    |     |      |     |    |      |      |      |    |     |      |     |    |      |      |      |    |     |      |     |    |      |      |      |    |     |      |      |    |      |      |      |    |     |      |      |    |      |      |      |    |     |      |      |    |      |      |      |    |     |      |      |    |      |      |      |    |      |      |      |    |      |      |      |    |      |      |      |    |      |      |      |
| 15                                                                                | 7.0                                                                                                                                                                                                                                                                                                                                                                                                                                                                                                                                                                                                                                                                                                                                                                                                                                                                                                                                                                                                                                                                                                                                                                                                                                                                                                                                                                                                                                                                                                                            | 8.0                             | 34                 | 16.5 17.5          |           |      |      |   |                    |           |   |     |     |    |           |    |     |     |    |           |    |     |     |    |           |    |     |     |    |           |    |     |     |    |           |    |     |     |    |           |    |     |     |    |           |    |     |     |    |           |    |     |      |    |           |    |      |      |    |           |    |      |      |    |           |                                                                                                                                                                                                                                                                                                                                                                                                                                                                                                                                                                                                                                                                                                                                                                                                                                                                                                                                                                                                                                                                                                                                                                                                  |                                 |      |    |           |    |     |      |                    |           |    |      |      |    |           |    |      |      |    |           |                                                                                                                                                                                                                                                                                                                                                                                                                                                                                                                                                                                                                                                                                                                                                                                                                                                                                                                                                                                                                                                                                                                                                                                                                                                                                                                                                                                                                                                                                                                                                                                                                                                                                                                                                                                                                                                                                                                                                                                                                                                                                         |                                 |     |    |           |    |     |     |    |           |    |                    |           |    |           |    |      |     |     |           |    |      |      |      |           |     |      |     |    |           |      |      |      |     |           |     |      |      |      |           |    |     |      |     |           |      |      |      |    |     |      |     |    |      |      |      |    |     |      |     |    |      |      |      |    |     |      |     |    |      |      |      |    |     |      |     |    |      |      |      |    |     |      |     |    |      |      |      |    |     |      |      |    |      |      |      |    |     |      |      |    |      |      |      |    |     |      |      |    |      |      |      |    |     |      |      |    |      |      |      |    |      |      |      |    |      |      |      |    |      |      |      |    |      |      |      |
| 16                                                                                | 7.5                                                                                                                                                                                                                                                                                                                                                                                                                                                                                                                                                                                                                                                                                                                                                                                                                                                                                                                                                                                                                                                                                                                                                                                                                                                                                                                                                                                                                                                                                                                            | 8.5                             | 36                 | 17.5 18.5          |           |      |      |   |                    |           |   |     |     |    |           |    |     |     |    |           |    |     |     |    |           |    |     |     |    |           |    |     |     |    |           |    |     |     |    |           |    |     |     |    |           |    |     |     |    |           |    |     |      |    |           |    |      |      |    |           |    |      |      |    |           |                                                                                                                                                                                                                                                                                                                                                                                                                                                                                                                                                                                                                                                                                                                                                                                                                                                                                                                                                                                                                                                                                                                                                                                                  |                                 |      |    |           |    |     |      |                    |           |    |      |      |    |           |    |      |      |    |           |                                                                                                                                                                                                                                                                                                                                                                                                                                                                                                                                                                                                                                                                                                                                                                                                                                                                                                                                                                                                                                                                                                                                                                                                                                                                                                                                                                                                                                                                                                                                                                                                                                                                                                                                                                                                                                                                                                                                                                                                                                                                                         |                                 |     |    |           |    |     |     |    |           |    |                    |           |    |           |    |      |     |     |           |    |      |      |      |           |     |      |     |    |           |      |      |      |     |           |     |      |      |      |           |    |     |      |     |           |      |      |      |    |     |      |     |    |      |      |      |    |     |      |     |    |      |      |      |    |     |      |     |    |      |      |      |    |     |      |     |    |      |      |      |    |     |      |     |    |      |      |      |    |     |      |      |    |      |      |      |    |     |      |      |    |      |      |      |    |     |      |      |    |      |      |      |    |     |      |      |    |      |      |      |    |      |      |      |    |      |      |      |    |      |      |      |    |      |      |      |
| 17                                                                                | 8.0                                                                                                                                                                                                                                                                                                                                                                                                                                                                                                                                                                                                                                                                                                                                                                                                                                                                                                                                                                                                                                                                                                                                                                                                                                                                                                                                                                                                                                                                                                                            | 9.0                             | 40                 | 19.5 20.5          |           |      |      |   |                    |           |   |     |     |    |           |    |     |     |    |           |    |     |     |    |           |    |     |     |    |           |    |     |     |    |           |    |     |     |    |           |    |     |     |    |           |    |     |     |    |           |    |     |      |    |           |    |      |      |    |           |    |      |      |    |           |                                                                                                                                                                                                                                                                                                                                                                                                                                                                                                                                                                                                                                                                                                                                                                                                                                                                                                                                                                                                                                                                                                                                                                                                  |                                 |      |    |           |    |     |      |                    |           |    |      |      |    |           |    |      |      |    |           |                                                                                                                                                                                                                                                                                                                                                                                                                                                                                                                                                                                                                                                                                                                                                                                                                                                                                                                                                                                                                                                                                                                                                                                                                                                                                                                                                                                                                                                                                                                                                                                                                                                                                                                                                                                                                                                                                                                                                                                                                                                                                         |                                 |     |    |           |    |     |     |    |           |    |                    |           |    |           |    |      |     |     |           |    |      |      |      |           |     |      |     |    |           |      |      |      |     |           |     |      |      |      |           |    |     |      |     |           |      |      |      |    |     |      |     |    |      |      |      |    |     |      |     |    |      |      |      |    |     |      |     |    |      |      |      |    |     |      |     |    |      |      |      |    |     |      |     |    |      |      |      |    |     |      |      |    |      |      |      |    |     |      |      |    |      |      |      |    |     |      |      |    |      |      |      |    |     |      |      |    |      |      |      |    |      |      |      |    |      |      |      |    |      |      |      |    |      |      |      |
| 18                                                                                | 8.5                                                                                                                                                                                                                                                                                                                                                                                                                                                                                                                                                                                                                                                                                                                                                                                                                                                                                                                                                                                                                                                                                                                                                                                                                                                                                                                                                                                                                                                                                                                            | 9.5                             | 45                 | 22.0 23.0          |           |      |      |   |                    |           |   |     |     |    |           |    |     |     |    |           |    |     |     |    |           |    |     |     |    |           |    |     |     |    |           |    |     |     |    |           |    |     |     |    |           |    |     |     |    |           |    |     |      |    |           |    |      |      |    |           |    |      |      |    |           |                                                                                                                                                                                                                                                                                                                                                                                                                                                                                                                                                                                                                                                                                                                                                                                                                                                                                                                                                                                                                                                                                                                                                                                                  |                                 |      |    |           |    |     |      |                    |           |    |      |      |    |           |    |      |      |    |           |                                                                                                                                                                                                                                                                                                                                                                                                                                                                                                                                                                                                                                                                                                                                                                                                                                                                                                                                                                                                                                                                                                                                                                                                                                                                                                                                                                                                                                                                                                                                                                                                                                                                                                                                                                                                                                                                                                                                                                                                                                                                                         |                                 |     |    |           |    |     |     |    |           |    |                    |           |    |           |    |      |     |     |           |    |      |      |      |           |     |      |     |    |           |      |      |      |     |           |     |      |      |      |           |    |     |      |     |           |      |      |      |    |     |      |     |    |      |      |      |    |     |      |     |    |      |      |      |    |     |      |     |    |      |      |      |    |     |      |     |    |      |      |      |    |     |      |     |    |      |      |      |    |     |      |      |    |      |      |      |    |     |      |      |    |      |      |      |    |     |      |      |    |      |      |      |    |     |      |      |    |      |      |      |    |      |      |      |    |      |      |      |    |      |      |      |    |      |      |      |
| 20                                                                                | 9.5                                                                                                                                                                                                                                                                                                                                                                                                                                                                                                                                                                                                                                                                                                                                                                                                                                                                                                                                                                                                                                                                                                                                                                                                                                                                                                                                                                                                                                                                                                                            | 10.5                            | 49                 | 24.0 25.0          |           |      |      |   |                    |           |   |     |     |    |           |    |     |     |    |           |    |     |     |    |           |    |     |     |    |           |    |     |     |    |           |    |     |     |    |           |    |     |     |    |           |    |     |     |    |           |    |     |      |    |           |    |      |      |    |           |    |      |      |    |           |                                                                                                                                                                                                                                                                                                                                                                                                                                                                                                                                                                                                                                                                                                                                                                                                                                                                                                                                                                                                                                                                                                                                                                                                  |                                 |      |    |           |    |     |      |                    |           |    |      |      |    |           |    |      |      |    |           |                                                                                                                                                                                                                                                                                                                                                                                                                                                                                                                                                                                                                                                                                                                                                                                                                                                                                                                                                                                                                                                                                                                                                                                                                                                                                                                                                                                                                                                                                                                                                                                                                                                                                                                                                                                                                                                                                                                                                                                                                                                                                         |                                 |     |    |           |    |     |     |    |           |    |                    |           |    |           |    |      |     |     |           |    |      |      |      |           |     |      |     |    |           |      |      |      |     |           |     |      |      |      |           |    |     |      |     |           |      |      |      |    |     |      |     |    |      |      |      |    |     |      |     |    |      |      |      |    |     |      |     |    |      |      |      |    |     |      |     |    |      |      |      |    |     |      |     |    |      |      |      |    |     |      |      |    |      |      |      |    |     |      |      |    |      |      |      |    |     |      |      |    |      |      |      |    |     |      |      |    |      |      |      |    |      |      |      |    |      |      |      |    |      |      |      |    |      |      |      |
| 22                                                                                | 10.5                                                                                                                                                                                                                                                                                                                                                                                                                                                                                                                                                                                                                                                                                                                                                                                                                                                                                                                                                                                                                                                                                                                                                                                                                                                                                                                                                                                                                                                                                                                           | 11.5                            | 50                 | 24.5 25.5          |           |      |      |   |                    |           |   |     |     |    |           |    |     |     |    |           |    |     |     |    |           |    |     |     |    |           |    |     |     |    |           |    |     |     |    |           |    |     |     |    |           |    |     |     |    |           |    |     |      |    |           |    |      |      |    |           |    |      |      |    |           |                                                                                                                                                                                                                                                                                                                                                                                                                                                                                                                                                                                                                                                                                                                                                                                                                                                                                                                                                                                                                                                                                                                                                                                                  |                                 |      |    |           |    |     |      |                    |           |    |      |      |    |           |    |      |      |    |           |                                                                                                                                                                                                                                                                                                                                                                                                                                                                                                                                                                                                                                                                                                                                                                                                                                                                                                                                                                                                                                                                                                                                                                                                                                                                                                                                                                                                                                                                                                                                                                                                                                                                                                                                                                                                                                                                                                                                                                                                                                                                                         |                                 |     |    |           |    |     |     |    |           |    |                    |           |    |           |    |      |     |     |           |    |      |      |      |           |     |      |     |    |           |      |      |      |     |           |     |      |      |      |           |    |     |      |     |           |      |      |      |    |     |      |     |    |      |      |      |    |     |      |     |    |      |      |      |    |     |      |     |    |      |      |      |    |     |      |     |    |      |      |      |    |     |      |     |    |      |      |      |    |     |      |      |    |      |      |      |    |     |      |      |    |      |      |      |    |     |      |      |    |      |      |      |    |     |      |      |    |      |      |      |    |      |      |      |    |      |      |      |    |      |      |      |    |      |      |      |
| 24                                                                                | 11.5                                                                                                                                                                                                                                                                                                                                                                                                                                                                                                                                                                                                                                                                                                                                                                                                                                                                                                                                                                                                                                                                                                                                                                                                                                                                                                                                                                                                                                                                                                                           | 12.5                            | 60                 | 29.5 30.5          |           |      |      |   |                    |           |   |     |     |    |           |    |     |     |    |           |    |     |     |    |           |    |     |     |    |           |    |     |     |    |           |    |     |     |    |           |    |     |     |    |           |    |     |     |    |           |    |     |      |    |           |    |      |      |    |           |    |      |      |    |           |                                                                                                                                                                                                                                                                                                                                                                                                                                                                                                                                                                                                                                                                                                                                                                                                                                                                                                                                                                                                                                                                                                                                                                                                  |                                 |      |    |           |    |     |      |                    |           |    |      |      |    |           |    |      |      |    |           |                                                                                                                                                                                                                                                                                                                                                                                                                                                                                                                                                                                                                                                                                                                                                                                                                                                                                                                                                                                                                                                                                                                                                                                                                                                                                                                                                                                                                                                                                                                                                                                                                                                                                                                                                                                                                                                                                                                                                                                                                                                                                         |                                 |     |    |           |    |     |     |    |           |    |                    |           |    |           |    |      |     |     |           |    |      |      |      |           |     |      |     |    |           |      |      |      |     |           |     |      |      |      |           |    |     |      |     |           |      |      |      |    |     |      |     |    |      |      |      |    |     |      |     |    |      |      |      |    |     |      |     |    |      |      |      |    |     |      |     |    |      |      |      |    |     |      |     |    |      |      |      |    |     |      |      |    |      |      |      |    |     |      |      |    |      |      |      |    |     |      |      |    |      |      |      |    |     |      |      |    |      |      |      |    |      |      |      |    |      |      |      |    |      |      |      |    |      |      |      |
| Dimension<br>Number of Contacts                                                   | A                                                                                                                                                                                                                                                                                                                                                                                                                                                                                                                                                                                                                                                                                                                                                                                                                                                                                                                                                                                                                                                                                                                                                                                                                                                                                                                                                                                                                                                                                                                              |                                 | B                  |                    |           |      |      |   |                    |           |   |     |     |    |           |    |     |     |    |           |    |     |     |    |           |    |     |     |    |           |    |     |     |    |           |    |     |     |    |           |    |     |     |    |           |    |     |     |    |           |    |     |      |    |           |    |      |      |    |           |    |      |      |    |           |                                                                                                                                                                                                                                                                                                                                                                                                                                                                                                                                                                                                                                                                                                                                                                                                                                                                                                                                                                                                                                                                                                                                                                                                  |                                 |      |    |           |    |     |      |                    |           |    |      |      |    |           |    |      |      |    |           |                                                                                                                                                                                                                                                                                                                                                                                                                                                                                                                                                                                                                                                                                                                                                                                                                                                                                                                                                                                                                                                                                                                                                                                                                                                                                                                                                                                                                                                                                                                                                                                                                                                                                                                                                                                                                                                                                                                                                                                                                                                                                         |                                 |     |    |           |    |     |     |    |           |    |                    |           |    |           |    |      |     |     |           |    |      |      |      |           |     |      |     |    |           |      |      |      |     |           |     |      |      |      |           |    |     |      |     |           |      |      |      |    |     |      |     |    |      |      |      |    |     |      |     |    |      |      |      |    |     |      |     |    |      |      |      |    |     |      |     |    |      |      |      |    |     |      |     |    |      |      |      |    |     |      |      |    |      |      |      |    |     |      |      |    |      |      |      |    |     |      |      |    |      |      |      |    |     |      |      |    |      |      |      |    |      |      |      |    |      |      |      |    |      |      |      |    |      |      |      |
|                                                                                   | A                                                                                                                                                                                                                                                                                                                                                                                                                                                                                                                                                                                                                                                                                                                                                                                                                                                                                                                                                                                                                                                                                                                                                                                                                                                                                                                                                                                                                                                                                                                              | B                               | Number of Contacts | Dimension          |           |      |      |   |                    |           |   |     |     |    |           |    |     |     |    |           |    |     |     |    |           |    |     |     |    |           |    |     |     |    |           |    |     |     |    |           |    |     |     |    |           |    |     |     |    |           |    |     |      |    |           |    |      |      |    |           |    |      |      |    |           |                                                                                                                                                                                                                                                                                                                                                                                                                                                                                                                                                                                                                                                                                                                                                                                                                                                                                                                                                                                                                                                                                                                                                                                                  |                                 |      |    |           |    |     |      |                    |           |    |      |      |    |           |    |      |      |    |           |                                                                                                                                                                                                                                                                                                                                                                                                                                                                                                                                                                                                                                                                                                                                                                                                                                                                                                                                                                                                                                                                                                                                                                                                                                                                                                                                                                                                                                                                                                                                                                                                                                                                                                                                                                                                                                                                                                                                                                                                                                                                                         |                                 |     |    |           |    |     |     |    |           |    |                    |           |    |           |    |      |     |     |           |    |      |      |      |           |     |      |     |    |           |      |      |      |     |           |     |      |      |      |           |    |     |      |     |           |      |      |      |    |     |      |     |    |      |      |      |    |     |      |     |    |      |      |      |    |     |      |     |    |      |      |      |    |     |      |     |    |      |      |      |    |     |      |     |    |      |      |      |    |     |      |      |    |      |      |      |    |     |      |      |    |      |      |      |    |     |      |      |    |      |      |      |    |     |      |      |    |      |      |      |    |      |      |      |    |      |      |      |    |      |      |      |    |      |      |      |
| 10                                                                                | 6.5                                                                                                                                                                                                                                                                                                                                                                                                                                                                                                                                                                                                                                                                                                                                                                                                                                                                                                                                                                                                                                                                                                                                                                                                                                                                                                                                                                                                                                                                                                                            | 4.5                             | 26                 | 14.5 12.5          |           |      |      |   |                    |           |   |     |     |    |           |    |     |     |    |           |    |     |     |    |           |    |     |     |    |           |    |     |     |    |           |    |     |     |    |           |    |     |     |    |           |    |     |     |    |           |    |     |      |    |           |    |      |      |    |           |    |      |      |    |           |                                                                                                                                                                                                                                                                                                                                                                                                                                                                                                                                                                                                                                                                                                                                                                                                                                                                                                                                                                                                                                                                                                                                                                                                  |                                 |      |    |           |    |     |      |                    |           |    |      |      |    |           |    |      |      |    |           |                                                                                                                                                                                                                                                                                                                                                                                                                                                                                                                                                                                                                                                                                                                                                                                                                                                                                                                                                                                                                                                                                                                                                                                                                                                                                                                                                                                                                                                                                                                                                                                                                                                                                                                                                                                                                                                                                                                                                                                                                                                                                         |                                 |     |    |           |    |     |     |    |           |    |                    |           |    |           |    |      |     |     |           |    |      |      |      |           |     |      |     |    |           |      |      |      |     |           |     |      |      |      |           |    |     |      |     |           |      |      |      |    |     |      |     |    |      |      |      |    |     |      |     |    |      |      |      |    |     |      |     |    |      |      |      |    |     |      |     |    |      |      |      |    |     |      |     |    |      |      |      |    |     |      |      |    |      |      |      |    |     |      |      |    |      |      |      |    |     |      |      |    |      |      |      |    |     |      |      |    |      |      |      |    |      |      |      |    |      |      |      |    |      |      |      |    |      |      |      |
| 12                                                                                | 7.5                                                                                                                                                                                                                                                                                                                                                                                                                                                                                                                                                                                                                                                                                                                                                                                                                                                                                                                                                                                                                                                                                                                                                                                                                                                                                                                                                                                                                                                                                                                            | 5.5                             | 30                 | 16.5 14.5          |           |      |      |   |                    |           |   |     |     |    |           |    |     |     |    |           |    |     |     |    |           |    |     |     |    |           |    |     |     |    |           |    |     |     |    |           |    |     |     |    |           |    |     |     |    |           |    |     |      |    |           |    |      |      |    |           |    |      |      |    |           |                                                                                                                                                                                                                                                                                                                                                                                                                                                                                                                                                                                                                                                                                                                                                                                                                                                                                                                                                                                                                                                                                                                                                                                                  |                                 |      |    |           |    |     |      |                    |           |    |      |      |    |           |    |      |      |    |           |                                                                                                                                                                                                                                                                                                                                                                                                                                                                                                                                                                                                                                                                                                                                                                                                                                                                                                                                                                                                                                                                                                                                                                                                                                                                                                                                                                                                                                                                                                                                                                                                                                                                                                                                                                                                                                                                                                                                                                                                                                                                                         |                                 |     |    |           |    |     |     |    |           |    |                    |           |    |           |    |      |     |     |           |    |      |      |      |           |     |      |     |    |           |      |      |      |     |           |     |      |      |      |           |    |     |      |     |           |      |      |      |    |     |      |     |    |      |      |      |    |     |      |     |    |      |      |      |    |     |      |     |    |      |      |      |    |     |      |     |    |      |      |      |    |     |      |     |    |      |      |      |    |     |      |      |    |      |      |      |    |     |      |      |    |      |      |      |    |     |      |      |    |      |      |      |    |     |      |      |    |      |      |      |    |      |      |      |    |      |      |      |    |      |      |      |    |      |      |      |
| 13                                                                                | 8.0                                                                                                                                                                                                                                                                                                                                                                                                                                                                                                                                                                                                                                                                                                                                                                                                                                                                                                                                                                                                                                                                                                                                                                                                                                                                                                                                                                                                                                                                                                                            | 6.0                             | 32                 | 17.5 15.5          |           |      |      |   |                    |           |   |     |     |    |           |    |     |     |    |           |    |     |     |    |           |    |     |     |    |           |    |     |     |    |           |    |     |     |    |           |    |     |     |    |           |    |     |     |    |           |    |     |      |    |           |    |      |      |    |           |    |      |      |    |           |                                                                                                                                                                                                                                                                                                                                                                                                                                                                                                                                                                                                                                                                                                                                                                                                                                                                                                                                                                                                                                                                                                                                                                                                  |                                 |      |    |           |    |     |      |                    |           |    |      |      |    |           |    |      |      |    |           |                                                                                                                                                                                                                                                                                                                                                                                                                                                                                                                                                                                                                                                                                                                                                                                                                                                                                                                                                                                                                                                                                                                                                                                                                                                                                                                                                                                                                                                                                                                                                                                                                                                                                                                                                                                                                                                                                                                                                                                                                                                                                         |                                 |     |    |           |    |     |     |    |           |    |                    |           |    |           |    |      |     |     |           |    |      |      |      |           |     |      |     |    |           |      |      |      |     |           |     |      |      |      |           |    |     |      |     |           |      |      |      |    |     |      |     |    |      |      |      |    |     |      |     |    |      |      |      |    |     |      |     |    |      |      |      |    |     |      |     |    |      |      |      |    |     |      |     |    |      |      |      |    |     |      |      |    |      |      |      |    |     |      |      |    |      |      |      |    |     |      |      |    |      |      |      |    |     |      |      |    |      |      |      |    |      |      |      |    |      |      |      |    |      |      |      |    |      |      |      |
| 15                                                                                | 9.0                                                                                                                                                                                                                                                                                                                                                                                                                                                                                                                                                                                                                                                                                                                                                                                                                                                                                                                                                                                                                                                                                                                                                                                                                                                                                                                                                                                                                                                                                                                            | 7.0                             | 33                 | 18.0 16.0          |           |      |      |   |                    |           |   |     |     |    |           |    |     |     |    |           |    |     |     |    |           |    |     |     |    |           |    |     |     |    |           |    |     |     |    |           |    |     |     |    |           |    |     |     |    |           |    |     |      |    |           |    |      |      |    |           |    |      |      |    |           |                                                                                                                                                                                                                                                                                                                                                                                                                                                                                                                                                                                                                                                                                                                                                                                                                                                                                                                                                                                                                                                                                                                                                                                                  |                                 |      |    |           |    |     |      |                    |           |    |      |      |    |           |    |      |      |    |           |                                                                                                                                                                                                                                                                                                                                                                                                                                                                                                                                                                                                                                                                                                                                                                                                                                                                                                                                                                                                                                                                                                                                                                                                                                                                                                                                                                                                                                                                                                                                                                                                                                                                                                                                                                                                                                                                                                                                                                                                                                                                                         |                                 |     |    |           |    |     |     |    |           |    |                    |           |    |           |    |      |     |     |           |    |      |      |      |           |     |      |     |    |           |      |      |      |     |           |     |      |      |      |           |    |     |      |     |           |      |      |      |    |     |      |     |    |      |      |      |    |     |      |     |    |      |      |      |    |     |      |     |    |      |      |      |    |     |      |     |    |      |      |      |    |     |      |     |    |      |      |      |    |     |      |      |    |      |      |      |    |     |      |      |    |      |      |      |    |     |      |      |    |      |      |      |    |     |      |      |    |      |      |      |    |      |      |      |    |      |      |      |    |      |      |      |    |      |      |      |
| 16                                                                                | 9.5                                                                                                                                                                                                                                                                                                                                                                                                                                                                                                                                                                                                                                                                                                                                                                                                                                                                                                                                                                                                                                                                                                                                                                                                                                                                                                                                                                                                                                                                                                                            | 7.5                             | 34                 | 18.5 16.5          |           |      |      |   |                    |           |   |     |     |    |           |    |     |     |    |           |    |     |     |    |           |    |     |     |    |           |    |     |     |    |           |    |     |     |    |           |    |     |     |    |           |    |     |     |    |           |    |     |      |    |           |    |      |      |    |           |    |      |      |    |           |                                                                                                                                                                                                                                                                                                                                                                                                                                                                                                                                                                                                                                                                                                                                                                                                                                                                                                                                                                                                                                                                                                                                                                                                  |                                 |      |    |           |    |     |      |                    |           |    |      |      |    |           |    |      |      |    |           |                                                                                                                                                                                                                                                                                                                                                                                                                                                                                                                                                                                                                                                                                                                                                                                                                                                                                                                                                                                                                                                                                                                                                                                                                                                                                                                                                                                                                                                                                                                                                                                                                                                                                                                                                                                                                                                                                                                                                                                                                                                                                         |                                 |     |    |           |    |     |     |    |           |    |                    |           |    |           |    |      |     |     |           |    |      |      |      |           |     |      |     |    |           |      |      |      |     |           |     |      |      |      |           |    |     |      |     |           |      |      |      |    |     |      |     |    |      |      |      |    |     |      |     |    |      |      |      |    |     |      |     |    |      |      |      |    |     |      |     |    |      |      |      |    |     |      |     |    |      |      |      |    |     |      |      |    |      |      |      |    |     |      |      |    |      |      |      |    |     |      |      |    |      |      |      |    |     |      |      |    |      |      |      |    |      |      |      |    |      |      |      |    |      |      |      |    |      |      |      |
| 17                                                                                | 10.0                                                                                                                                                                                                                                                                                                                                                                                                                                                                                                                                                                                                                                                                                                                                                                                                                                                                                                                                                                                                                                                                                                                                                                                                                                                                                                                                                                                                                                                                                                                           | 8.0                             | 36                 | 19.5 17.5          |           |      |      |   |                    |           |   |     |     |    |           |    |     |     |    |           |    |     |     |    |           |    |     |     |    |           |    |     |     |    |           |    |     |     |    |           |    |     |     |    |           |    |     |     |    |           |    |     |      |    |           |    |      |      |    |           |    |      |      |    |           |                                                                                                                                                                                                                                                                                                                                                                                                                                                                                                                                                                                                                                                                                                                                                                                                                                                                                                                                                                                                                                                                                                                                                                                                  |                                 |      |    |           |    |     |      |                    |           |    |      |      |    |           |    |      |      |    |           |                                                                                                                                                                                                                                                                                                                                                                                                                                                                                                                                                                                                                                                                                                                                                                                                                                                                                                                                                                                                                                                                                                                                                                                                                                                                                                                                                                                                                                                                                                                                                                                                                                                                                                                                                                                                                                                                                                                                                                                                                                                                                         |                                 |     |    |           |    |     |     |    |           |    |                    |           |    |           |    |      |     |     |           |    |      |      |      |           |     |      |     |    |           |      |      |      |     |           |     |      |      |      |           |    |     |      |     |           |      |      |      |    |     |      |     |    |      |      |      |    |     |      |     |    |      |      |      |    |     |      |     |    |      |      |      |    |     |      |     |    |      |      |      |    |     |      |     |    |      |      |      |    |     |      |      |    |      |      |      |    |     |      |      |    |      |      |      |    |     |      |      |    |      |      |      |    |     |      |      |    |      |      |      |    |      |      |      |    |      |      |      |    |      |      |      |    |      |      |      |
| 18                                                                                | 10.5                                                                                                                                                                                                                                                                                                                                                                                                                                                                                                                                                                                                                                                                                                                                                                                                                                                                                                                                                                                                                                                                                                                                                                                                                                                                                                                                                                                                                                                                                                                           | 8.5                             | 40                 | 21.5 19.5          |           |      |      |   |                    |           |   |     |     |    |           |    |     |     |    |           |    |     |     |    |           |    |     |     |    |           |    |     |     |    |           |    |     |     |    |           |    |     |     |    |           |    |     |     |    |           |    |     |      |    |           |    |      |      |    |           |    |      |      |    |           |                                                                                                                                                                                                                                                                                                                                                                                                                                                                                                                                                                                                                                                                                                                                                                                                                                                                                                                                                                                                                                                                                                                                                                                                  |                                 |      |    |           |    |     |      |                    |           |    |      |      |    |           |    |      |      |    |           |                                                                                                                                                                                                                                                                                                                                                                                                                                                                                                                                                                                                                                                                                                                                                                                                                                                                                                                                                                                                                                                                                                                                                                                                                                                                                                                                                                                                                                                                                                                                                                                                                                                                                                                                                                                                                                                                                                                                                                                                                                                                                         |                                 |     |    |           |    |     |     |    |           |    |                    |           |    |           |    |      |     |     |           |    |      |      |      |           |     |      |     |    |           |      |      |      |     |           |     |      |      |      |           |    |     |      |     |           |      |      |      |    |     |      |     |    |      |      |      |    |     |      |     |    |      |      |      |    |     |      |     |    |      |      |      |    |     |      |     |    |      |      |      |    |     |      |     |    |      |      |      |    |     |      |      |    |      |      |      |    |     |      |      |    |      |      |      |    |     |      |      |    |      |      |      |    |     |      |      |    |      |      |      |    |      |      |      |    |      |      |      |    |      |      |      |    |      |      |      |
| 20                                                                                | 11.5                                                                                                                                                                                                                                                                                                                                                                                                                                                                                                                                                                                                                                                                                                                                                                                                                                                                                                                                                                                                                                                                                                                                                                                                                                                                                                                                                                                                                                                                                                                           | 9.5                             | 45                 | 24.0 22.0          |           |      |      |   |                    |           |   |     |     |    |           |    |     |     |    |           |    |     |     |    |           |    |     |     |    |           |    |     |     |    |           |    |     |     |    |           |    |     |     |    |           |    |     |     |    |           |    |     |      |    |           |    |      |      |    |           |    |      |      |    |           |                                                                                                                                                                                                                                                                                                                                                                                                                                                                                                                                                                                                                                                                                                                                                                                                                                                                                                                                                                                                                                                                                                                                                                                                  |                                 |      |    |           |    |     |      |                    |           |    |      |      |    |           |    |      |      |    |           |                                                                                                                                                                                                                                                                                                                                                                                                                                                                                                                                                                                                                                                                                                                                                                                                                                                                                                                                                                                                                                                                                                                                                                                                                                                                                                                                                                                                                                                                                                                                                                                                                                                                                                                                                                                                                                                                                                                                                                                                                                                                                         |                                 |     |    |           |    |     |     |    |           |    |                    |           |    |           |    |      |     |     |           |    |      |      |      |           |     |      |     |    |           |      |      |      |     |           |     |      |      |      |           |    |     |      |     |           |      |      |      |    |     |      |     |    |      |      |      |    |     |      |     |    |      |      |      |    |     |      |     |    |      |      |      |    |     |      |     |    |      |      |      |    |     |      |     |    |      |      |      |    |     |      |      |    |      |      |      |    |     |      |      |    |      |      |      |    |     |      |      |    |      |      |      |    |     |      |      |    |      |      |      |    |      |      |      |    |      |      |      |    |      |      |      |    |      |      |      |
| 22                                                                                | 12.5                                                                                                                                                                                                                                                                                                                                                                                                                                                                                                                                                                                                                                                                                                                                                                                                                                                                                                                                                                                                                                                                                                                                                                                                                                                                                                                                                                                                                                                                                                                           | 10.5                            | 49                 | 26.0 24.0          |           |      |      |   |                    |           |   |     |     |    |           |    |     |     |    |           |    |     |     |    |           |    |     |     |    |           |    |     |     |    |           |    |     |     |    |           |    |     |     |    |           |    |     |     |    |           |    |     |      |    |           |    |      |      |    |           |    |      |      |    |           |                                                                                                                                                                                                                                                                                                                                                                                                                                                                                                                                                                                                                                                                                                                                                                                                                                                                                                                                                                                                                                                                                                                                                                                                  |                                 |      |    |           |    |     |      |                    |           |    |      |      |    |           |    |      |      |    |           |                                                                                                                                                                                                                                                                                                                                                                                                                                                                                                                                                                                                                                                                                                                                                                                                                                                                                                                                                                                                                                                                                                                                                                                                                                                                                                                                                                                                                                                                                                                                                                                                                                                                                                                                                                                                                                                                                                                                                                                                                                                                                         |                                 |     |    |           |    |     |     |    |           |    |                    |           |    |           |    |      |     |     |           |    |      |      |      |           |     |      |     |    |           |      |      |      |     |           |     |      |      |      |           |    |     |      |     |           |      |      |      |    |     |      |     |    |      |      |      |    |     |      |     |    |      |      |      |    |     |      |     |    |      |      |      |    |     |      |     |    |      |      |      |    |     |      |     |    |      |      |      |    |     |      |      |    |      |      |      |    |     |      |      |    |      |      |      |    |     |      |      |    |      |      |      |    |     |      |      |    |      |      |      |    |      |      |      |    |      |      |      |    |      |      |      |    |      |      |      |
| 24                                                                                | 13.5                                                                                                                                                                                                                                                                                                                                                                                                                                                                                                                                                                                                                                                                                                                                                                                                                                                                                                                                                                                                                                                                                                                                                                                                                                                                                                                                                                                                                                                                                                                           | 11.5                            | 50                 | 26.5 24.5          |           |      |      |   |                    |           |   |     |     |    |           |    |     |     |    |           |    |     |     |    |           |    |     |     |    |           |    |     |     |    |           |    |     |     |    |           |    |     |     |    |           |    |     |     |    |           |    |     |      |    |           |    |      |      |    |           |    |      |      |    |           |                                                                                                                                                                                                                                                                                                                                                                                                                                                                                                                                                                                                                                                                                                                                                                                                                                                                                                                                                                                                                                                                                                                                                                                                  |                                 |      |    |           |    |     |      |                    |           |    |      |      |    |           |    |      |      |    |           |                                                                                                                                                                                                                                                                                                                                                                                                                                                                                                                                                                                                                                                                                                                                                                                                                                                                                                                                                                                                                                                                                                                                                                                                                                                                                                                                                                                                                                                                                                                                                                                                                                                                                                                                                                                                                                                                                                                                                                                                                                                                                         |                                 |     |    |           |    |     |     |    |           |    |                    |           |    |           |    |      |     |     |           |    |      |      |      |           |     |      |     |    |           |      |      |      |     |           |     |      |      |      |           |    |     |      |     |           |      |      |      |    |     |      |     |    |      |      |      |    |     |      |     |    |      |      |      |    |     |      |     |    |      |      |      |    |     |      |     |    |      |      |      |    |     |      |     |    |      |      |      |    |     |      |      |    |      |      |      |    |     |      |      |    |      |      |      |    |     |      |      |    |      |      |      |    |     |      |      |    |      |      |      |    |      |      |      |    |      |      |      |    |      |      |      |    |      |      |      |
|                                                                                   |                                                                                                                                                                                                                                                                                                                                                                                                                                                                                                                                                                                                                                                                                                                                                                                                                                                                                                                                                                                                                                                                                                                                                                                                                                                                                                                                                                                                                                                                                                                                |                                 | 60                 | 31.5 29.5          |           |      |      |   |                    |           |   |     |     |    |           |    |     |     |    |           |    |     |     |    |           |    |     |     |    |           |    |     |     |    |           |    |     |     |    |           |    |     |     |    |           |    |     |     |    |           |    |     |      |    |           |    |      |      |    |           |    |      |      |    |           |                                                                                                                                                                                                                                                                                                                                                                                                                                                                                                                                                                                                                                                                                                                                                                                                                                                                                                                                                                                                                                                                                                                                                                                                  |                                 |      |    |           |    |     |      |                    |           |    |      |      |    |           |    |      |      |    |           |                                                                                                                                                                                                                                                                                                                                                                                                                                                                                                                                                                                                                                                                                                                                                                                                                                                                                                                                                                                                                                                                                                                                                                                                                                                                                                                                                                                                                                                                                                                                                                                                                                                                                                                                                                                                                                                                                                                                                                                                                                                                                         |                                 |     |    |           |    |     |     |    |           |    |                    |           |    |           |    |      |     |     |           |    |      |      |      |           |     |      |     |    |           |      |      |      |     |           |     |      |      |      |           |    |     |      |     |           |      |      |      |    |     |      |     |    |      |      |      |    |     |      |     |    |      |      |      |    |     |      |     |    |      |      |      |    |     |      |     |    |      |      |      |    |     |      |     |    |      |      |      |    |     |      |      |    |      |      |      |    |     |      |      |    |      |      |      |    |     |      |      |    |      |      |      |    |     |      |      |    |      |      |      |    |      |      |      |    |      |      |      |    |      |      |      |    |      |      |      |

Aug. 1. 2021 Copyright 2021 HIROSE ELECTRIC CO., LTD. All Rights Reserved.

# ◆ Recommended FPC/FFC dimensions and Land/Metal Mask dimensions

## ● 1mm Pitch Product

|                                         | FPC/FFC dimensions                                                                                                                                                                                                                                                                                                                                                                                                                                                                                                                                                                                                                                                                                                                                                                                                                                                                                                                                                                                                                                                                                                                                                                                                                                                                                                                                                                                                                                                                                                                 | Land / Metal Mask dimensions    |               |     |    |                                 |                                 |                |   |   |   |   |   |   |   |    |    |    |    |    |    |     |     |    |    |    |    |                                                                                                                                                                                                                                                                                                                                                                                                                                                                                                                                                                                                      |                                 |               |     |   |   |   |   |   |   |     |     |   |    |   |    |    |    |      |     |    |    |    |    |    |    |      |     |    |    |    |   |    |    |      |     |    |    |    |   |    |    |      |     |    |    |    |   |    |    |      |     |    |    |    |   |  |  |  |  |    |    |    |   |  |  |  |  |    |    |    |   |  |  |  |  |                                                                                                                                                                                                                                                                                                                                                                                                                                                                                                                                                                                                                                                                                                                                                                                                                                                                                                                                                                                                                                                                                                                                                                                                                                                                                                                                                                                                                                                                                                                                                                                                                                                                                                                                                                                                                                          |                                 |               |  |  |  |  |                                 |                |  |  |  |  |   |   |   |   |   |   |   |   |   |   |      |   |     |   |   |      |     |   |   |   |      |   |     |   |   |      |     |   |   |   |      |   |     |   |   |      |      |   |   |   |      |    |     |    |   |      |      |   |   |   |      |    |     |    |    |      |      |   |    |    |      |    |     |    |    |      |      |   |    |    |      |    |     |    |    |      |      |   |    |    |      |    |     |    |    |      |      |   |    |    |      |    |     |  |  |  |  |  |    |    |      |    |     |  |  |  |  |  |    |    |      |    |     |  |  |  |  |  |
|-----------------------------------------|------------------------------------------------------------------------------------------------------------------------------------------------------------------------------------------------------------------------------------------------------------------------------------------------------------------------------------------------------------------------------------------------------------------------------------------------------------------------------------------------------------------------------------------------------------------------------------------------------------------------------------------------------------------------------------------------------------------------------------------------------------------------------------------------------------------------------------------------------------------------------------------------------------------------------------------------------------------------------------------------------------------------------------------------------------------------------------------------------------------------------------------------------------------------------------------------------------------------------------------------------------------------------------------------------------------------------------------------------------------------------------------------------------------------------------------------------------------------------------------------------------------------------------|---------------------------------|---------------|-----|----|---------------------------------|---------------------------------|----------------|---|---|---|---|---|---|---|----|----|----|----|----|----|-----|-----|----|----|----|----|------------------------------------------------------------------------------------------------------------------------------------------------------------------------------------------------------------------------------------------------------------------------------------------------------------------------------------------------------------------------------------------------------------------------------------------------------------------------------------------------------------------------------------------------------------------------------------------------------|---------------------------------|---------------|-----|---|---|---|---|---|---|-----|-----|---|----|---|----|----|----|------|-----|----|----|----|----|----|----|------|-----|----|----|----|---|----|----|------|-----|----|----|----|---|----|----|------|-----|----|----|----|---|----|----|------|-----|----|----|----|---|--|--|--|--|----|----|----|---|--|--|--|--|----|----|----|---|--|--|--|--|------------------------------------------------------------------------------------------------------------------------------------------------------------------------------------------------------------------------------------------------------------------------------------------------------------------------------------------------------------------------------------------------------------------------------------------------------------------------------------------------------------------------------------------------------------------------------------------------------------------------------------------------------------------------------------------------------------------------------------------------------------------------------------------------------------------------------------------------------------------------------------------------------------------------------------------------------------------------------------------------------------------------------------------------------------------------------------------------------------------------------------------------------------------------------------------------------------------------------------------------------------------------------------------------------------------------------------------------------------------------------------------------------------------------------------------------------------------------------------------------------------------------------------------------------------------------------------------------------------------------------------------------------------------------------------------------------------------------------------------------------------------------------------------------------------------------------------------|---------------------------------|---------------|--|--|--|--|---------------------------------|----------------|--|--|--|--|---|---|---|---|---|---|---|---|---|---|------|---|-----|---|---|------|-----|---|---|---|------|---|-----|---|---|------|-----|---|---|---|------|---|-----|---|---|------|------|---|---|---|------|----|-----|----|---|------|------|---|---|---|------|----|-----|----|----|------|------|---|----|----|------|----|-----|----|----|------|------|---|----|----|------|----|-----|----|----|------|------|---|----|----|------|----|-----|----|----|------|------|---|----|----|------|----|-----|--|--|--|--|--|----|----|------|----|-----|--|--|--|--|--|----|----|------|----|-----|--|--|--|--|--|
| <b>1mm Pitch Bottom Contact Type</b>    | <p>※Set the stiffener thickness to 0.188 (7.5mil) min.</p> <p style="text-align: right;">Unit : mm</p> <table border="1"> <thead> <tr> <th rowspan="2">Dimension<br/>Number of Contacts</th> <th colspan="3">Standard Type</th> <th rowspan="2">Dimension<br/>Number of Contacts</th> <th colspan="3">Eccentric Type</th> </tr> <tr> <th>A</th> <th>B</th> <th>C</th> <th>A</th> <th>B</th> <th>C</th> </tr> </thead> <tbody> <tr><td>5</td><td>4</td><td>6</td><td>1</td><td>4</td><td>3</td><td>5.5</td><td>1.5</td></tr> <tr><td>6</td><td>5</td><td>7</td><td>1</td><td>6</td><td>5</td><td>7.5</td><td>1.5</td></tr> <tr><td>7</td><td>6</td><td>8</td><td>1</td><td>8</td><td>7</td><td>9.5</td><td>1.5</td></tr> <tr><td>8</td><td>7</td><td>9</td><td>1</td><td>10</td><td>9</td><td>11.5</td><td>1.5</td></tr> <tr><td>9</td><td>8</td><td>10</td><td>1</td><td>11</td><td>10</td><td>12.5</td><td>1.5</td></tr> <tr><td>11</td><td>10</td><td>12</td><td>1</td><td>14</td><td>13</td><td>15.5</td><td>1.5</td></tr> <tr><td>12</td><td>11</td><td>13</td><td>1</td><td>19</td><td>18</td><td>20.5</td><td>1.5</td></tr> <tr><td>16</td><td>15</td><td>17</td><td>1</td><td>24</td><td>23</td><td>25.5</td><td>1.5</td></tr> <tr><td>17</td><td>16</td><td>18</td><td>1</td><td></td><td></td><td></td><td></td></tr> <tr><td>22</td><td>21</td><td>23</td><td>1</td><td></td><td></td><td></td><td></td></tr> <tr><td>26</td><td>25</td><td>27</td><td>1</td><td></td><td></td><td></td><td></td></tr> </tbody> </table> | Dimension<br>Number of Contacts | Standard Type |     |    | Dimension<br>Number of Contacts | Eccentric Type                  |                |   | A | B | C | A | B | C | 5  | 4  | 6  | 1  | 4  | 3  | 5.5 | 1.5 | 6  | 5  | 7  | 1  | 6                                                                                                                                                                                                                                                                                                                                                                                                                                                                                                                                                                                                    | 5                               | 7.5           | 1.5 | 7 | 6 | 8 | 1 | 8 | 7 | 9.5 | 1.5 | 8 | 7  | 9 | 1  | 10 | 9  | 11.5 | 1.5 | 9  | 8  | 10 | 1  | 11 | 10 | 12.5 | 1.5 | 11 | 10 | 12 | 1 | 14 | 13 | 15.5 | 1.5 | 12 | 11 | 13 | 1 | 19 | 18 | 20.5 | 1.5 | 16 | 15 | 17 | 1 | 24 | 23 | 25.5 | 1.5 | 17 | 16 | 18 | 1 |  |  |  |  | 22 | 21 | 23 | 1 |  |  |  |  | 26 | 25 | 27 | 1 |  |  |  |  | <p>Recommended metal mask thickness : 0.15mm</p> <p style="text-align: right;">Unit : mm</p> <table border="1"> <thead> <tr> <th rowspan="2">Dimension<br/>Number of Contacts</th> <th colspan="5">Standard Type</th> <th rowspan="2">Dimension<br/>Number of Contacts</th> <th colspan="5">Eccentric Type</th> </tr> <tr> <th>A</th> <th>B</th> <th>C</th> <th>D</th> <th>A</th> <th>B</th> <th>C</th> <th>D</th> </tr> </thead> <tbody> <tr><td>5</td><td>4</td><td>10.6</td><td>7</td><td>1.5</td><td>4</td><td>3</td><td>10.1</td><td>6.5</td><td>2</td></tr> <tr><td>6</td><td>5</td><td>11.6</td><td>8</td><td>1.5</td><td>6</td><td>5</td><td>12.1</td><td>8.5</td><td>2</td></tr> <tr><td>7</td><td>6</td><td>12.6</td><td>9</td><td>1.5</td><td>8</td><td>7</td><td>14.1</td><td>10.5</td><td>2</td></tr> <tr><td>8</td><td>7</td><td>13.6</td><td>10</td><td>1.5</td><td>10</td><td>9</td><td>16.1</td><td>12.5</td><td>2</td></tr> <tr><td>9</td><td>8</td><td>14.6</td><td>11</td><td>1.5</td><td>11</td><td>10</td><td>17.1</td><td>13.5</td><td>2</td></tr> <tr><td>11</td><td>10</td><td>16.6</td><td>13</td><td>1.5</td><td>14</td><td>13</td><td>20.1</td><td>16.5</td><td>2</td></tr> <tr><td>12</td><td>11</td><td>17.6</td><td>14</td><td>1.5</td><td>19</td><td>18</td><td>25.1</td><td>21.5</td><td>2</td></tr> <tr><td>16</td><td>15</td><td>21.6</td><td>18</td><td>1.5</td><td>24</td><td>23</td><td>30.1</td><td>26.5</td><td>2</td></tr> <tr><td>17</td><td>16</td><td>22.6</td><td>19</td><td>1.5</td><td></td><td></td><td></td><td></td><td></td></tr> <tr><td>22</td><td>21</td><td>27.6</td><td>24</td><td>1.5</td><td></td><td></td><td></td><td></td><td></td></tr> <tr><td>26</td><td>25</td><td>31.6</td><td>28</td><td>1.5</td><td></td><td></td><td></td><td></td><td></td></tr> </tbody> </table> | Dimension<br>Number of Contacts | Standard Type |  |  |  |  | Dimension<br>Number of Contacts | Eccentric Type |  |  |  |  | A | B | C | D | A | B | C | D | 5 | 4 | 10.6 | 7 | 1.5 | 4 | 3 | 10.1 | 6.5 | 2 | 6 | 5 | 11.6 | 8 | 1.5 | 6 | 5 | 12.1 | 8.5 | 2 | 7 | 6 | 12.6 | 9 | 1.5 | 8 | 7 | 14.1 | 10.5 | 2 | 8 | 7 | 13.6 | 10 | 1.5 | 10 | 9 | 16.1 | 12.5 | 2 | 9 | 8 | 14.6 | 11 | 1.5 | 11 | 10 | 17.1 | 13.5 | 2 | 11 | 10 | 16.6 | 13 | 1.5 | 14 | 13 | 20.1 | 16.5 | 2 | 12 | 11 | 17.6 | 14 | 1.5 | 19 | 18 | 25.1 | 21.5 | 2 | 16 | 15 | 21.6 | 18 | 1.5 | 24 | 23 | 30.1 | 26.5 | 2 | 17 | 16 | 22.6 | 19 | 1.5 |  |  |  |  |  | 22 | 21 | 27.6 | 24 | 1.5 |  |  |  |  |  | 26 | 25 | 31.6 | 28 | 1.5 |  |  |  |  |  |
|                                         | Dimension<br>Number of Contacts                                                                                                                                                                                                                                                                                                                                                                                                                                                                                                                                                                                                                                                                                                                                                                                                                                                                                                                                                                                                                                                                                                                                                                                                                                                                                                                                                                                                                                                                                                    |                                 | Standard Type |     |    |                                 | Dimension<br>Number of Contacts | Eccentric Type |   |   |   |   |   |   |   |    |    |    |    |    |    |     |     |    |    |    |    |                                                                                                                                                                                                                                                                                                                                                                                                                                                                                                                                                                                                      |                                 |               |     |   |   |   |   |   |   |     |     |   |    |   |    |    |    |      |     |    |    |    |    |    |    |      |     |    |    |    |   |    |    |      |     |    |    |    |   |    |    |      |     |    |    |    |   |    |    |      |     |    |    |    |   |  |  |  |  |    |    |    |   |  |  |  |  |    |    |    |   |  |  |  |  |                                                                                                                                                                                                                                                                                                                                                                                                                                                                                                                                                                                                                                                                                                                                                                                                                                                                                                                                                                                                                                                                                                                                                                                                                                                                                                                                                                                                                                                                                                                                                                                                                                                                                                                                                                                                                                          |                                 |               |  |  |  |  |                                 |                |  |  |  |  |   |   |   |   |   |   |   |   |   |   |      |   |     |   |   |      |     |   |   |   |      |   |     |   |   |      |     |   |   |   |      |   |     |   |   |      |      |   |   |   |      |    |     |    |   |      |      |   |   |   |      |    |     |    |    |      |      |   |    |    |      |    |     |    |    |      |      |   |    |    |      |    |     |    |    |      |      |   |    |    |      |    |     |    |    |      |      |   |    |    |      |    |     |  |  |  |  |  |    |    |      |    |     |  |  |  |  |  |    |    |      |    |     |  |  |  |  |  |
| A                                       |                                                                                                                                                                                                                                                                                                                                                                                                                                                                                                                                                                                                                                                                                                                                                                                                                                                                                                                                                                                                                                                                                                                                                                                                                                                                                                                                                                                                                                                                                                                                    | B                               | C             | A   | B  | C                               |                                 |                |   |   |   |   |   |   |   |    |    |    |    |    |    |     |     |    |    |    |    |                                                                                                                                                                                                                                                                                                                                                                                                                                                                                                                                                                                                      |                                 |               |     |   |   |   |   |   |   |     |     |   |    |   |    |    |    |      |     |    |    |    |    |    |    |      |     |    |    |    |   |    |    |      |     |    |    |    |   |    |    |      |     |    |    |    |   |    |    |      |     |    |    |    |   |  |  |  |  |    |    |    |   |  |  |  |  |    |    |    |   |  |  |  |  |                                                                                                                                                                                                                                                                                                                                                                                                                                                                                                                                                                                                                                                                                                                                                                                                                                                                                                                                                                                                                                                                                                                                                                                                                                                                                                                                                                                                                                                                                                                                                                                                                                                                                                                                                                                                                                          |                                 |               |  |  |  |  |                                 |                |  |  |  |  |   |   |   |   |   |   |   |   |   |   |      |   |     |   |   |      |     |   |   |   |      |   |     |   |   |      |     |   |   |   |      |   |     |   |   |      |      |   |   |   |      |    |     |    |   |      |      |   |   |   |      |    |     |    |    |      |      |   |    |    |      |    |     |    |    |      |      |   |    |    |      |    |     |    |    |      |      |   |    |    |      |    |     |    |    |      |      |   |    |    |      |    |     |  |  |  |  |  |    |    |      |    |     |  |  |  |  |  |    |    |      |    |     |  |  |  |  |  |
| 5                                       | 4                                                                                                                                                                                                                                                                                                                                                                                                                                                                                                                                                                                                                                                                                                                                                                                                                                                                                                                                                                                                                                                                                                                                                                                                                                                                                                                                                                                                                                                                                                                                  | 6                               | 1             | 4   | 3  | 5.5                             | 1.5                             |                |   |   |   |   |   |   |   |    |    |    |    |    |    |     |     |    |    |    |    |                                                                                                                                                                                                                                                                                                                                                                                                                                                                                                                                                                                                      |                                 |               |     |   |   |   |   |   |   |     |     |   |    |   |    |    |    |      |     |    |    |    |    |    |    |      |     |    |    |    |   |    |    |      |     |    |    |    |   |    |    |      |     |    |    |    |   |    |    |      |     |    |    |    |   |  |  |  |  |    |    |    |   |  |  |  |  |    |    |    |   |  |  |  |  |                                                                                                                                                                                                                                                                                                                                                                                                                                                                                                                                                                                                                                                                                                                                                                                                                                                                                                                                                                                                                                                                                                                                                                                                                                                                                                                                                                                                                                                                                                                                                                                                                                                                                                                                                                                                                                          |                                 |               |  |  |  |  |                                 |                |  |  |  |  |   |   |   |   |   |   |   |   |   |   |      |   |     |   |   |      |     |   |   |   |      |   |     |   |   |      |     |   |   |   |      |   |     |   |   |      |      |   |   |   |      |    |     |    |   |      |      |   |   |   |      |    |     |    |    |      |      |   |    |    |      |    |     |    |    |      |      |   |    |    |      |    |     |    |    |      |      |   |    |    |      |    |     |    |    |      |      |   |    |    |      |    |     |  |  |  |  |  |    |    |      |    |     |  |  |  |  |  |    |    |      |    |     |  |  |  |  |  |
| 6                                       | 5                                                                                                                                                                                                                                                                                                                                                                                                                                                                                                                                                                                                                                                                                                                                                                                                                                                                                                                                                                                                                                                                                                                                                                                                                                                                                                                                                                                                                                                                                                                                  | 7                               | 1             | 6   | 5  | 7.5                             | 1.5                             |                |   |   |   |   |   |   |   |    |    |    |    |    |    |     |     |    |    |    |    |                                                                                                                                                                                                                                                                                                                                                                                                                                                                                                                                                                                                      |                                 |               |     |   |   |   |   |   |   |     |     |   |    |   |    |    |    |      |     |    |    |    |    |    |    |      |     |    |    |    |   |    |    |      |     |    |    |    |   |    |    |      |     |    |    |    |   |    |    |      |     |    |    |    |   |  |  |  |  |    |    |    |   |  |  |  |  |    |    |    |   |  |  |  |  |                                                                                                                                                                                                                                                                                                                                                                                                                                                                                                                                                                                                                                                                                                                                                                                                                                                                                                                                                                                                                                                                                                                                                                                                                                                                                                                                                                                                                                                                                                                                                                                                                                                                                                                                                                                                                                          |                                 |               |  |  |  |  |                                 |                |  |  |  |  |   |   |   |   |   |   |   |   |   |   |      |   |     |   |   |      |     |   |   |   |      |   |     |   |   |      |     |   |   |   |      |   |     |   |   |      |      |   |   |   |      |    |     |    |   |      |      |   |   |   |      |    |     |    |    |      |      |   |    |    |      |    |     |    |    |      |      |   |    |    |      |    |     |    |    |      |      |   |    |    |      |    |     |    |    |      |      |   |    |    |      |    |     |  |  |  |  |  |    |    |      |    |     |  |  |  |  |  |    |    |      |    |     |  |  |  |  |  |
| 7                                       | 6                                                                                                                                                                                                                                                                                                                                                                                                                                                                                                                                                                                                                                                                                                                                                                                                                                                                                                                                                                                                                                                                                                                                                                                                                                                                                                                                                                                                                                                                                                                                  | 8                               | 1             | 8   | 7  | 9.5                             | 1.5                             |                |   |   |   |   |   |   |   |    |    |    |    |    |    |     |     |    |    |    |    |                                                                                                                                                                                                                                                                                                                                                                                                                                                                                                                                                                                                      |                                 |               |     |   |   |   |   |   |   |     |     |   |    |   |    |    |    |      |     |    |    |    |    |    |    |      |     |    |    |    |   |    |    |      |     |    |    |    |   |    |    |      |     |    |    |    |   |    |    |      |     |    |    |    |   |  |  |  |  |    |    |    |   |  |  |  |  |    |    |    |   |  |  |  |  |                                                                                                                                                                                                                                                                                                                                                                                                                                                                                                                                                                                                                                                                                                                                                                                                                                                                                                                                                                                                                                                                                                                                                                                                                                                                                                                                                                                                                                                                                                                                                                                                                                                                                                                                                                                                                                          |                                 |               |  |  |  |  |                                 |                |  |  |  |  |   |   |   |   |   |   |   |   |   |   |      |   |     |   |   |      |     |   |   |   |      |   |     |   |   |      |     |   |   |   |      |   |     |   |   |      |      |   |   |   |      |    |     |    |   |      |      |   |   |   |      |    |     |    |    |      |      |   |    |    |      |    |     |    |    |      |      |   |    |    |      |    |     |    |    |      |      |   |    |    |      |    |     |    |    |      |      |   |    |    |      |    |     |  |  |  |  |  |    |    |      |    |     |  |  |  |  |  |    |    |      |    |     |  |  |  |  |  |
| 8                                       | 7                                                                                                                                                                                                                                                                                                                                                                                                                                                                                                                                                                                                                                                                                                                                                                                                                                                                                                                                                                                                                                                                                                                                                                                                                                                                                                                                                                                                                                                                                                                                  | 9                               | 1             | 10  | 9  | 11.5                            | 1.5                             |                |   |   |   |   |   |   |   |    |    |    |    |    |    |     |     |    |    |    |    |                                                                                                                                                                                                                                                                                                                                                                                                                                                                                                                                                                                                      |                                 |               |     |   |   |   |   |   |   |     |     |   |    |   |    |    |    |      |     |    |    |    |    |    |    |      |     |    |    |    |   |    |    |      |     |    |    |    |   |    |    |      |     |    |    |    |   |    |    |      |     |    |    |    |   |  |  |  |  |    |    |    |   |  |  |  |  |    |    |    |   |  |  |  |  |                                                                                                                                                                                                                                                                                                                                                                                                                                                                                                                                                                                                                                                                                                                                                                                                                                                                                                                                                                                                                                                                                                                                                                                                                                                                                                                                                                                                                                                                                                                                                                                                                                                                                                                                                                                                                                          |                                 |               |  |  |  |  |                                 |                |  |  |  |  |   |   |   |   |   |   |   |   |   |   |      |   |     |   |   |      |     |   |   |   |      |   |     |   |   |      |     |   |   |   |      |   |     |   |   |      |      |   |   |   |      |    |     |    |   |      |      |   |   |   |      |    |     |    |    |      |      |   |    |    |      |    |     |    |    |      |      |   |    |    |      |    |     |    |    |      |      |   |    |    |      |    |     |    |    |      |      |   |    |    |      |    |     |  |  |  |  |  |    |    |      |    |     |  |  |  |  |  |    |    |      |    |     |  |  |  |  |  |
| 9                                       | 8                                                                                                                                                                                                                                                                                                                                                                                                                                                                                                                                                                                                                                                                                                                                                                                                                                                                                                                                                                                                                                                                                                                                                                                                                                                                                                                                                                                                                                                                                                                                  | 10                              | 1             | 11  | 10 | 12.5                            | 1.5                             |                |   |   |   |   |   |   |   |    |    |    |    |    |    |     |     |    |    |    |    |                                                                                                                                                                                                                                                                                                                                                                                                                                                                                                                                                                                                      |                                 |               |     |   |   |   |   |   |   |     |     |   |    |   |    |    |    |      |     |    |    |    |    |    |    |      |     |    |    |    |   |    |    |      |     |    |    |    |   |    |    |      |     |    |    |    |   |    |    |      |     |    |    |    |   |  |  |  |  |    |    |    |   |  |  |  |  |    |    |    |   |  |  |  |  |                                                                                                                                                                                                                                                                                                                                                                                                                                                                                                                                                                                                                                                                                                                                                                                                                                                                                                                                                                                                                                                                                                                                                                                                                                                                                                                                                                                                                                                                                                                                                                                                                                                                                                                                                                                                                                          |                                 |               |  |  |  |  |                                 |                |  |  |  |  |   |   |   |   |   |   |   |   |   |   |      |   |     |   |   |      |     |   |   |   |      |   |     |   |   |      |     |   |   |   |      |   |     |   |   |      |      |   |   |   |      |    |     |    |   |      |      |   |   |   |      |    |     |    |    |      |      |   |    |    |      |    |     |    |    |      |      |   |    |    |      |    |     |    |    |      |      |   |    |    |      |    |     |    |    |      |      |   |    |    |      |    |     |  |  |  |  |  |    |    |      |    |     |  |  |  |  |  |    |    |      |    |     |  |  |  |  |  |
| 11                                      | 10                                                                                                                                                                                                                                                                                                                                                                                                                                                                                                                                                                                                                                                                                                                                                                                                                                                                                                                                                                                                                                                                                                                                                                                                                                                                                                                                                                                                                                                                                                                                 | 12                              | 1             | 14  | 13 | 15.5                            | 1.5                             |                |   |   |   |   |   |   |   |    |    |    |    |    |    |     |     |    |    |    |    |                                                                                                                                                                                                                                                                                                                                                                                                                                                                                                                                                                                                      |                                 |               |     |   |   |   |   |   |   |     |     |   |    |   |    |    |    |      |     |    |    |    |    |    |    |      |     |    |    |    |   |    |    |      |     |    |    |    |   |    |    |      |     |    |    |    |   |    |    |      |     |    |    |    |   |  |  |  |  |    |    |    |   |  |  |  |  |    |    |    |   |  |  |  |  |                                                                                                                                                                                                                                                                                                                                                                                                                                                                                                                                                                                                                                                                                                                                                                                                                                                                                                                                                                                                                                                                                                                                                                                                                                                                                                                                                                                                                                                                                                                                                                                                                                                                                                                                                                                                                                          |                                 |               |  |  |  |  |                                 |                |  |  |  |  |   |   |   |   |   |   |   |   |   |   |      |   |     |   |   |      |     |   |   |   |      |   |     |   |   |      |     |   |   |   |      |   |     |   |   |      |      |   |   |   |      |    |     |    |   |      |      |   |   |   |      |    |     |    |    |      |      |   |    |    |      |    |     |    |    |      |      |   |    |    |      |    |     |    |    |      |      |   |    |    |      |    |     |    |    |      |      |   |    |    |      |    |     |  |  |  |  |  |    |    |      |    |     |  |  |  |  |  |    |    |      |    |     |  |  |  |  |  |
| 12                                      | 11                                                                                                                                                                                                                                                                                                                                                                                                                                                                                                                                                                                                                                                                                                                                                                                                                                                                                                                                                                                                                                                                                                                                                                                                                                                                                                                                                                                                                                                                                                                                 | 13                              | 1             | 19  | 18 | 20.5                            | 1.5                             |                |   |   |   |   |   |   |   |    |    |    |    |    |    |     |     |    |    |    |    |                                                                                                                                                                                                                                                                                                                                                                                                                                                                                                                                                                                                      |                                 |               |     |   |   |   |   |   |   |     |     |   |    |   |    |    |    |      |     |    |    |    |    |    |    |      |     |    |    |    |   |    |    |      |     |    |    |    |   |    |    |      |     |    |    |    |   |    |    |      |     |    |    |    |   |  |  |  |  |    |    |    |   |  |  |  |  |    |    |    |   |  |  |  |  |                                                                                                                                                                                                                                                                                                                                                                                                                                                                                                                                                                                                                                                                                                                                                                                                                                                                                                                                                                                                                                                                                                                                                                                                                                                                                                                                                                                                                                                                                                                                                                                                                                                                                                                                                                                                                                          |                                 |               |  |  |  |  |                                 |                |  |  |  |  |   |   |   |   |   |   |   |   |   |   |      |   |     |   |   |      |     |   |   |   |      |   |     |   |   |      |     |   |   |   |      |   |     |   |   |      |      |   |   |   |      |    |     |    |   |      |      |   |   |   |      |    |     |    |    |      |      |   |    |    |      |    |     |    |    |      |      |   |    |    |      |    |     |    |    |      |      |   |    |    |      |    |     |    |    |      |      |   |    |    |      |    |     |  |  |  |  |  |    |    |      |    |     |  |  |  |  |  |    |    |      |    |     |  |  |  |  |  |
| 16                                      | 15                                                                                                                                                                                                                                                                                                                                                                                                                                                                                                                                                                                                                                                                                                                                                                                                                                                                                                                                                                                                                                                                                                                                                                                                                                                                                                                                                                                                                                                                                                                                 | 17                              | 1             | 24  | 23 | 25.5                            | 1.5                             |                |   |   |   |   |   |   |   |    |    |    |    |    |    |     |     |    |    |    |    |                                                                                                                                                                                                                                                                                                                                                                                                                                                                                                                                                                                                      |                                 |               |     |   |   |   |   |   |   |     |     |   |    |   |    |    |    |      |     |    |    |    |    |    |    |      |     |    |    |    |   |    |    |      |     |    |    |    |   |    |    |      |     |    |    |    |   |    |    |      |     |    |    |    |   |  |  |  |  |    |    |    |   |  |  |  |  |    |    |    |   |  |  |  |  |                                                                                                                                                                                                                                                                                                                                                                                                                                                                                                                                                                                                                                                                                                                                                                                                                                                                                                                                                                                                                                                                                                                                                                                                                                                                                                                                                                                                                                                                                                                                                                                                                                                                                                                                                                                                                                          |                                 |               |  |  |  |  |                                 |                |  |  |  |  |   |   |   |   |   |   |   |   |   |   |      |   |     |   |   |      |     |   |   |   |      |   |     |   |   |      |     |   |   |   |      |   |     |   |   |      |      |   |   |   |      |    |     |    |   |      |      |   |   |   |      |    |     |    |    |      |      |   |    |    |      |    |     |    |    |      |      |   |    |    |      |    |     |    |    |      |      |   |    |    |      |    |     |    |    |      |      |   |    |    |      |    |     |  |  |  |  |  |    |    |      |    |     |  |  |  |  |  |    |    |      |    |     |  |  |  |  |  |
| 17                                      | 16                                                                                                                                                                                                                                                                                                                                                                                                                                                                                                                                                                                                                                                                                                                                                                                                                                                                                                                                                                                                                                                                                                                                                                                                                                                                                                                                                                                                                                                                                                                                 | 18                              | 1             |     |    |                                 |                                 |                |   |   |   |   |   |   |   |    |    |    |    |    |    |     |     |    |    |    |    |                                                                                                                                                                                                                                                                                                                                                                                                                                                                                                                                                                                                      |                                 |               |     |   |   |   |   |   |   |     |     |   |    |   |    |    |    |      |     |    |    |    |    |    |    |      |     |    |    |    |   |    |    |      |     |    |    |    |   |    |    |      |     |    |    |    |   |    |    |      |     |    |    |    |   |  |  |  |  |    |    |    |   |  |  |  |  |    |    |    |   |  |  |  |  |                                                                                                                                                                                                                                                                                                                                                                                                                                                                                                                                                                                                                                                                                                                                                                                                                                                                                                                                                                                                                                                                                                                                                                                                                                                                                                                                                                                                                                                                                                                                                                                                                                                                                                                                                                                                                                          |                                 |               |  |  |  |  |                                 |                |  |  |  |  |   |   |   |   |   |   |   |   |   |   |      |   |     |   |   |      |     |   |   |   |      |   |     |   |   |      |     |   |   |   |      |   |     |   |   |      |      |   |   |   |      |    |     |    |   |      |      |   |   |   |      |    |     |    |    |      |      |   |    |    |      |    |     |    |    |      |      |   |    |    |      |    |     |    |    |      |      |   |    |    |      |    |     |    |    |      |      |   |    |    |      |    |     |  |  |  |  |  |    |    |      |    |     |  |  |  |  |  |    |    |      |    |     |  |  |  |  |  |
| 22                                      | 21                                                                                                                                                                                                                                                                                                                                                                                                                                                                                                                                                                                                                                                                                                                                                                                                                                                                                                                                                                                                                                                                                                                                                                                                                                                                                                                                                                                                                                                                                                                                 | 23                              | 1             |     |    |                                 |                                 |                |   |   |   |   |   |   |   |    |    |    |    |    |    |     |     |    |    |    |    |                                                                                                                                                                                                                                                                                                                                                                                                                                                                                                                                                                                                      |                                 |               |     |   |   |   |   |   |   |     |     |   |    |   |    |    |    |      |     |    |    |    |    |    |    |      |     |    |    |    |   |    |    |      |     |    |    |    |   |    |    |      |     |    |    |    |   |    |    |      |     |    |    |    |   |  |  |  |  |    |    |    |   |  |  |  |  |    |    |    |   |  |  |  |  |                                                                                                                                                                                                                                                                                                                                                                                                                                                                                                                                                                                                                                                                                                                                                                                                                                                                                                                                                                                                                                                                                                                                                                                                                                                                                                                                                                                                                                                                                                                                                                                                                                                                                                                                                                                                                                          |                                 |               |  |  |  |  |                                 |                |  |  |  |  |   |   |   |   |   |   |   |   |   |   |      |   |     |   |   |      |     |   |   |   |      |   |     |   |   |      |     |   |   |   |      |   |     |   |   |      |      |   |   |   |      |    |     |    |   |      |      |   |   |   |      |    |     |    |    |      |      |   |    |    |      |    |     |    |    |      |      |   |    |    |      |    |     |    |    |      |      |   |    |    |      |    |     |    |    |      |      |   |    |    |      |    |     |  |  |  |  |  |    |    |      |    |     |  |  |  |  |  |    |    |      |    |     |  |  |  |  |  |
| 26                                      | 25                                                                                                                                                                                                                                                                                                                                                                                                                                                                                                                                                                                                                                                                                                                                                                                                                                                                                                                                                                                                                                                                                                                                                                                                                                                                                                                                                                                                                                                                                                                                 | 27                              | 1             |     |    |                                 |                                 |                |   |   |   |   |   |   |   |    |    |    |    |    |    |     |     |    |    |    |    |                                                                                                                                                                                                                                                                                                                                                                                                                                                                                                                                                                                                      |                                 |               |     |   |   |   |   |   |   |     |     |   |    |   |    |    |    |      |     |    |    |    |    |    |    |      |     |    |    |    |   |    |    |      |     |    |    |    |   |    |    |      |     |    |    |    |   |    |    |      |     |    |    |    |   |  |  |  |  |    |    |    |   |  |  |  |  |    |    |    |   |  |  |  |  |                                                                                                                                                                                                                                                                                                                                                                                                                                                                                                                                                                                                                                                                                                                                                                                                                                                                                                                                                                                                                                                                                                                                                                                                                                                                                                                                                                                                                                                                                                                                                                                                                                                                                                                                                                                                                                          |                                 |               |  |  |  |  |                                 |                |  |  |  |  |   |   |   |   |   |   |   |   |   |   |      |   |     |   |   |      |     |   |   |   |      |   |     |   |   |      |     |   |   |   |      |   |     |   |   |      |      |   |   |   |      |    |     |    |   |      |      |   |   |   |      |    |     |    |    |      |      |   |    |    |      |    |     |    |    |      |      |   |    |    |      |    |     |    |    |      |      |   |    |    |      |    |     |    |    |      |      |   |    |    |      |    |     |  |  |  |  |  |    |    |      |    |     |  |  |  |  |  |    |    |      |    |     |  |  |  |  |  |
| Dimension<br>Number of Contacts         | Standard Type                                                                                                                                                                                                                                                                                                                                                                                                                                                                                                                                                                                                                                                                                                                                                                                                                                                                                                                                                                                                                                                                                                                                                                                                                                                                                                                                                                                                                                                                                                                      |                                 |               |     |    | Dimension<br>Number of Contacts | Eccentric Type                  |                |   |   |   |   |   |   |   |    |    |    |    |    |    |     |     |    |    |    |    |                                                                                                                                                                                                                                                                                                                                                                                                                                                                                                                                                                                                      |                                 |               |     |   |   |   |   |   |   |     |     |   |    |   |    |    |    |      |     |    |    |    |    |    |    |      |     |    |    |    |   |    |    |      |     |    |    |    |   |    |    |      |     |    |    |    |   |    |    |      |     |    |    |    |   |  |  |  |  |    |    |    |   |  |  |  |  |    |    |    |   |  |  |  |  |                                                                                                                                                                                                                                                                                                                                                                                                                                                                                                                                                                                                                                                                                                                                                                                                                                                                                                                                                                                                                                                                                                                                                                                                                                                                                                                                                                                                                                                                                                                                                                                                                                                                                                                                                                                                                                          |                                 |               |  |  |  |  |                                 |                |  |  |  |  |   |   |   |   |   |   |   |   |   |   |      |   |     |   |   |      |     |   |   |   |      |   |     |   |   |      |     |   |   |   |      |   |     |   |   |      |      |   |   |   |      |    |     |    |   |      |      |   |   |   |      |    |     |    |    |      |      |   |    |    |      |    |     |    |    |      |      |   |    |    |      |    |     |    |    |      |      |   |    |    |      |    |     |    |    |      |      |   |    |    |      |    |     |  |  |  |  |  |    |    |      |    |     |  |  |  |  |  |    |    |      |    |     |  |  |  |  |  |
|                                         | A                                                                                                                                                                                                                                                                                                                                                                                                                                                                                                                                                                                                                                                                                                                                                                                                                                                                                                                                                                                                                                                                                                                                                                                                                                                                                                                                                                                                                                                                                                                                  | B                               | C             | D   | A  |                                 | B                               | C              | D |   |   |   |   |   |   |    |    |    |    |    |    |     |     |    |    |    |    |                                                                                                                                                                                                                                                                                                                                                                                                                                                                                                                                                                                                      |                                 |               |     |   |   |   |   |   |   |     |     |   |    |   |    |    |    |      |     |    |    |    |    |    |    |      |     |    |    |    |   |    |    |      |     |    |    |    |   |    |    |      |     |    |    |    |   |    |    |      |     |    |    |    |   |  |  |  |  |    |    |    |   |  |  |  |  |    |    |    |   |  |  |  |  |                                                                                                                                                                                                                                                                                                                                                                                                                                                                                                                                                                                                                                                                                                                                                                                                                                                                                                                                                                                                                                                                                                                                                                                                                                                                                                                                                                                                                                                                                                                                                                                                                                                                                                                                                                                                                                          |                                 |               |  |  |  |  |                                 |                |  |  |  |  |   |   |   |   |   |   |   |   |   |   |      |   |     |   |   |      |     |   |   |   |      |   |     |   |   |      |     |   |   |   |      |   |     |   |   |      |      |   |   |   |      |    |     |    |   |      |      |   |   |   |      |    |     |    |    |      |      |   |    |    |      |    |     |    |    |      |      |   |    |    |      |    |     |    |    |      |      |   |    |    |      |    |     |    |    |      |      |   |    |    |      |    |     |  |  |  |  |  |    |    |      |    |     |  |  |  |  |  |    |    |      |    |     |  |  |  |  |  |
| 5                                       | 4                                                                                                                                                                                                                                                                                                                                                                                                                                                                                                                                                                                                                                                                                                                                                                                                                                                                                                                                                                                                                                                                                                                                                                                                                                                                                                                                                                                                                                                                                                                                  | 10.6                            | 7             | 1.5 | 4  | 3                               | 10.1                            | 6.5            | 2 |   |   |   |   |   |   |    |    |    |    |    |    |     |     |    |    |    |    |                                                                                                                                                                                                                                                                                                                                                                                                                                                                                                                                                                                                      |                                 |               |     |   |   |   |   |   |   |     |     |   |    |   |    |    |    |      |     |    |    |    |    |    |    |      |     |    |    |    |   |    |    |      |     |    |    |    |   |    |    |      |     |    |    |    |   |    |    |      |     |    |    |    |   |  |  |  |  |    |    |    |   |  |  |  |  |    |    |    |   |  |  |  |  |                                                                                                                                                                                                                                                                                                                                                                                                                                                                                                                                                                                                                                                                                                                                                                                                                                                                                                                                                                                                                                                                                                                                                                                                                                                                                                                                                                                                                                                                                                                                                                                                                                                                                                                                                                                                                                          |                                 |               |  |  |  |  |                                 |                |  |  |  |  |   |   |   |   |   |   |   |   |   |   |      |   |     |   |   |      |     |   |   |   |      |   |     |   |   |      |     |   |   |   |      |   |     |   |   |      |      |   |   |   |      |    |     |    |   |      |      |   |   |   |      |    |     |    |    |      |      |   |    |    |      |    |     |    |    |      |      |   |    |    |      |    |     |    |    |      |      |   |    |    |      |    |     |    |    |      |      |   |    |    |      |    |     |  |  |  |  |  |    |    |      |    |     |  |  |  |  |  |    |    |      |    |     |  |  |  |  |  |
| 6                                       | 5                                                                                                                                                                                                                                                                                                                                                                                                                                                                                                                                                                                                                                                                                                                                                                                                                                                                                                                                                                                                                                                                                                                                                                                                                                                                                                                                                                                                                                                                                                                                  | 11.6                            | 8             | 1.5 | 6  | 5                               | 12.1                            | 8.5            | 2 |   |   |   |   |   |   |    |    |    |    |    |    |     |     |    |    |    |    |                                                                                                                                                                                                                                                                                                                                                                                                                                                                                                                                                                                                      |                                 |               |     |   |   |   |   |   |   |     |     |   |    |   |    |    |    |      |     |    |    |    |    |    |    |      |     |    |    |    |   |    |    |      |     |    |    |    |   |    |    |      |     |    |    |    |   |    |    |      |     |    |    |    |   |  |  |  |  |    |    |    |   |  |  |  |  |    |    |    |   |  |  |  |  |                                                                                                                                                                                                                                                                                                                                                                                                                                                                                                                                                                                                                                                                                                                                                                                                                                                                                                                                                                                                                                                                                                                                                                                                                                                                                                                                                                                                                                                                                                                                                                                                                                                                                                                                                                                                                                          |                                 |               |  |  |  |  |                                 |                |  |  |  |  |   |   |   |   |   |   |   |   |   |   |      |   |     |   |   |      |     |   |   |   |      |   |     |   |   |      |     |   |   |   |      |   |     |   |   |      |      |   |   |   |      |    |     |    |   |      |      |   |   |   |      |    |     |    |    |      |      |   |    |    |      |    |     |    |    |      |      |   |    |    |      |    |     |    |    |      |      |   |    |    |      |    |     |    |    |      |      |   |    |    |      |    |     |  |  |  |  |  |    |    |      |    |     |  |  |  |  |  |    |    |      |    |     |  |  |  |  |  |
| 7                                       | 6                                                                                                                                                                                                                                                                                                                                                                                                                                                                                                                                                                                                                                                                                                                                                                                                                                                                                                                                                                                                                                                                                                                                                                                                                                                                                                                                                                                                                                                                                                                                  | 12.6                            | 9             | 1.5 | 8  | 7                               | 14.1                            | 10.5           | 2 |   |   |   |   |   |   |    |    |    |    |    |    |     |     |    |    |    |    |                                                                                                                                                                                                                                                                                                                                                                                                                                                                                                                                                                                                      |                                 |               |     |   |   |   |   |   |   |     |     |   |    |   |    |    |    |      |     |    |    |    |    |    |    |      |     |    |    |    |   |    |    |      |     |    |    |    |   |    |    |      |     |    |    |    |   |    |    |      |     |    |    |    |   |  |  |  |  |    |    |    |   |  |  |  |  |    |    |    |   |  |  |  |  |                                                                                                                                                                                                                                                                                                                                                                                                                                                                                                                                                                                                                                                                                                                                                                                                                                                                                                                                                                                                                                                                                                                                                                                                                                                                                                                                                                                                                                                                                                                                                                                                                                                                                                                                                                                                                                          |                                 |               |  |  |  |  |                                 |                |  |  |  |  |   |   |   |   |   |   |   |   |   |   |      |   |     |   |   |      |     |   |   |   |      |   |     |   |   |      |     |   |   |   |      |   |     |   |   |      |      |   |   |   |      |    |     |    |   |      |      |   |   |   |      |    |     |    |    |      |      |   |    |    |      |    |     |    |    |      |      |   |    |    |      |    |     |    |    |      |      |   |    |    |      |    |     |    |    |      |      |   |    |    |      |    |     |  |  |  |  |  |    |    |      |    |     |  |  |  |  |  |    |    |      |    |     |  |  |  |  |  |
| 8                                       | 7                                                                                                                                                                                                                                                                                                                                                                                                                                                                                                                                                                                                                                                                                                                                                                                                                                                                                                                                                                                                                                                                                                                                                                                                                                                                                                                                                                                                                                                                                                                                  | 13.6                            | 10            | 1.5 | 10 | 9                               | 16.1                            | 12.5           | 2 |   |   |   |   |   |   |    |    |    |    |    |    |     |     |    |    |    |    |                                                                                                                                                                                                                                                                                                                                                                                                                                                                                                                                                                                                      |                                 |               |     |   |   |   |   |   |   |     |     |   |    |   |    |    |    |      |     |    |    |    |    |    |    |      |     |    |    |    |   |    |    |      |     |    |    |    |   |    |    |      |     |    |    |    |   |    |    |      |     |    |    |    |   |  |  |  |  |    |    |    |   |  |  |  |  |    |    |    |   |  |  |  |  |                                                                                                                                                                                                                                                                                                                                                                                                                                                                                                                                                                                                                                                                                                                                                                                                                                                                                                                                                                                                                                                                                                                                                                                                                                                                                                                                                                                                                                                                                                                                                                                                                                                                                                                                                                                                                                          |                                 |               |  |  |  |  |                                 |                |  |  |  |  |   |   |   |   |   |   |   |   |   |   |      |   |     |   |   |      |     |   |   |   |      |   |     |   |   |      |     |   |   |   |      |   |     |   |   |      |      |   |   |   |      |    |     |    |   |      |      |   |   |   |      |    |     |    |    |      |      |   |    |    |      |    |     |    |    |      |      |   |    |    |      |    |     |    |    |      |      |   |    |    |      |    |     |    |    |      |      |   |    |    |      |    |     |  |  |  |  |  |    |    |      |    |     |  |  |  |  |  |    |    |      |    |     |  |  |  |  |  |
| 9                                       | 8                                                                                                                                                                                                                                                                                                                                                                                                                                                                                                                                                                                                                                                                                                                                                                                                                                                                                                                                                                                                                                                                                                                                                                                                                                                                                                                                                                                                                                                                                                                                  | 14.6                            | 11            | 1.5 | 11 | 10                              | 17.1                            | 13.5           | 2 |   |   |   |   |   |   |    |    |    |    |    |    |     |     |    |    |    |    |                                                                                                                                                                                                                                                                                                                                                                                                                                                                                                                                                                                                      |                                 |               |     |   |   |   |   |   |   |     |     |   |    |   |    |    |    |      |     |    |    |    |    |    |    |      |     |    |    |    |   |    |    |      |     |    |    |    |   |    |    |      |     |    |    |    |   |    |    |      |     |    |    |    |   |  |  |  |  |    |    |    |   |  |  |  |  |    |    |    |   |  |  |  |  |                                                                                                                                                                                                                                                                                                                                                                                                                                                                                                                                                                                                                                                                                                                                                                                                                                                                                                                                                                                                                                                                                                                                                                                                                                                                                                                                                                                                                                                                                                                                                                                                                                                                                                                                                                                                                                          |                                 |               |  |  |  |  |                                 |                |  |  |  |  |   |   |   |   |   |   |   |   |   |   |      |   |     |   |   |      |     |   |   |   |      |   |     |   |   |      |     |   |   |   |      |   |     |   |   |      |      |   |   |   |      |    |     |    |   |      |      |   |   |   |      |    |     |    |    |      |      |   |    |    |      |    |     |    |    |      |      |   |    |    |      |    |     |    |    |      |      |   |    |    |      |    |     |    |    |      |      |   |    |    |      |    |     |  |  |  |  |  |    |    |      |    |     |  |  |  |  |  |    |    |      |    |     |  |  |  |  |  |
| 11                                      | 10                                                                                                                                                                                                                                                                                                                                                                                                                                                                                                                                                                                                                                                                                                                                                                                                                                                                                                                                                                                                                                                                                                                                                                                                                                                                                                                                                                                                                                                                                                                                 | 16.6                            | 13            | 1.5 | 14 | 13                              | 20.1                            | 16.5           | 2 |   |   |   |   |   |   |    |    |    |    |    |    |     |     |    |    |    |    |                                                                                                                                                                                                                                                                                                                                                                                                                                                                                                                                                                                                      |                                 |               |     |   |   |   |   |   |   |     |     |   |    |   |    |    |    |      |     |    |    |    |    |    |    |      |     |    |    |    |   |    |    |      |     |    |    |    |   |    |    |      |     |    |    |    |   |    |    |      |     |    |    |    |   |  |  |  |  |    |    |    |   |  |  |  |  |    |    |    |   |  |  |  |  |                                                                                                                                                                                                                                                                                                                                                                                                                                                                                                                                                                                                                                                                                                                                                                                                                                                                                                                                                                                                                                                                                                                                                                                                                                                                                                                                                                                                                                                                                                                                                                                                                                                                                                                                                                                                                                          |                                 |               |  |  |  |  |                                 |                |  |  |  |  |   |   |   |   |   |   |   |   |   |   |      |   |     |   |   |      |     |   |   |   |      |   |     |   |   |      |     |   |   |   |      |   |     |   |   |      |      |   |   |   |      |    |     |    |   |      |      |   |   |   |      |    |     |    |    |      |      |   |    |    |      |    |     |    |    |      |      |   |    |    |      |    |     |    |    |      |      |   |    |    |      |    |     |    |    |      |      |   |    |    |      |    |     |  |  |  |  |  |    |    |      |    |     |  |  |  |  |  |    |    |      |    |     |  |  |  |  |  |
| 12                                      | 11                                                                                                                                                                                                                                                                                                                                                                                                                                                                                                                                                                                                                                                                                                                                                                                                                                                                                                                                                                                                                                                                                                                                                                                                                                                                                                                                                                                                                                                                                                                                 | 17.6                            | 14            | 1.5 | 19 | 18                              | 25.1                            | 21.5           | 2 |   |   |   |   |   |   |    |    |    |    |    |    |     |     |    |    |    |    |                                                                                                                                                                                                                                                                                                                                                                                                                                                                                                                                                                                                      |                                 |               |     |   |   |   |   |   |   |     |     |   |    |   |    |    |    |      |     |    |    |    |    |    |    |      |     |    |    |    |   |    |    |      |     |    |    |    |   |    |    |      |     |    |    |    |   |    |    |      |     |    |    |    |   |  |  |  |  |    |    |    |   |  |  |  |  |    |    |    |   |  |  |  |  |                                                                                                                                                                                                                                                                                                                                                                                                                                                                                                                                                                                                                                                                                                                                                                                                                                                                                                                                                                                                                                                                                                                                                                                                                                                                                                                                                                                                                                                                                                                                                                                                                                                                                                                                                                                                                                          |                                 |               |  |  |  |  |                                 |                |  |  |  |  |   |   |   |   |   |   |   |   |   |   |      |   |     |   |   |      |     |   |   |   |      |   |     |   |   |      |     |   |   |   |      |   |     |   |   |      |      |   |   |   |      |    |     |    |   |      |      |   |   |   |      |    |     |    |    |      |      |   |    |    |      |    |     |    |    |      |      |   |    |    |      |    |     |    |    |      |      |   |    |    |      |    |     |    |    |      |      |   |    |    |      |    |     |  |  |  |  |  |    |    |      |    |     |  |  |  |  |  |    |    |      |    |     |  |  |  |  |  |
| 16                                      | 15                                                                                                                                                                                                                                                                                                                                                                                                                                                                                                                                                                                                                                                                                                                                                                                                                                                                                                                                                                                                                                                                                                                                                                                                                                                                                                                                                                                                                                                                                                                                 | 21.6                            | 18            | 1.5 | 24 | 23                              | 30.1                            | 26.5           | 2 |   |   |   |   |   |   |    |    |    |    |    |    |     |     |    |    |    |    |                                                                                                                                                                                                                                                                                                                                                                                                                                                                                                                                                                                                      |                                 |               |     |   |   |   |   |   |   |     |     |   |    |   |    |    |    |      |     |    |    |    |    |    |    |      |     |    |    |    |   |    |    |      |     |    |    |    |   |    |    |      |     |    |    |    |   |    |    |      |     |    |    |    |   |  |  |  |  |    |    |    |   |  |  |  |  |    |    |    |   |  |  |  |  |                                                                                                                                                                                                                                                                                                                                                                                                                                                                                                                                                                                                                                                                                                                                                                                                                                                                                                                                                                                                                                                                                                                                                                                                                                                                                                                                                                                                                                                                                                                                                                                                                                                                                                                                                                                                                                          |                                 |               |  |  |  |  |                                 |                |  |  |  |  |   |   |   |   |   |   |   |   |   |   |      |   |     |   |   |      |     |   |   |   |      |   |     |   |   |      |     |   |   |   |      |   |     |   |   |      |      |   |   |   |      |    |     |    |   |      |      |   |   |   |      |    |     |    |    |      |      |   |    |    |      |    |     |    |    |      |      |   |    |    |      |    |     |    |    |      |      |   |    |    |      |    |     |    |    |      |      |   |    |    |      |    |     |  |  |  |  |  |    |    |      |    |     |  |  |  |  |  |    |    |      |    |     |  |  |  |  |  |
| 17                                      | 16                                                                                                                                                                                                                                                                                                                                                                                                                                                                                                                                                                                                                                                                                                                                                                                                                                                                                                                                                                                                                                                                                                                                                                                                                                                                                                                                                                                                                                                                                                                                 | 22.6                            | 19            | 1.5 |    |                                 |                                 |                |   |   |   |   |   |   |   |    |    |    |    |    |    |     |     |    |    |    |    |                                                                                                                                                                                                                                                                                                                                                                                                                                                                                                                                                                                                      |                                 |               |     |   |   |   |   |   |   |     |     |   |    |   |    |    |    |      |     |    |    |    |    |    |    |      |     |    |    |    |   |    |    |      |     |    |    |    |   |    |    |      |     |    |    |    |   |    |    |      |     |    |    |    |   |  |  |  |  |    |    |    |   |  |  |  |  |    |    |    |   |  |  |  |  |                                                                                                                                                                                                                                                                                                                                                                                                                                                                                                                                                                                                                                                                                                                                                                                                                                                                                                                                                                                                                                                                                                                                                                                                                                                                                                                                                                                                                                                                                                                                                                                                                                                                                                                                                                                                                                          |                                 |               |  |  |  |  |                                 |                |  |  |  |  |   |   |   |   |   |   |   |   |   |   |      |   |     |   |   |      |     |   |   |   |      |   |     |   |   |      |     |   |   |   |      |   |     |   |   |      |      |   |   |   |      |    |     |    |   |      |      |   |   |   |      |    |     |    |    |      |      |   |    |    |      |    |     |    |    |      |      |   |    |    |      |    |     |    |    |      |      |   |    |    |      |    |     |    |    |      |      |   |    |    |      |    |     |  |  |  |  |  |    |    |      |    |     |  |  |  |  |  |    |    |      |    |     |  |  |  |  |  |
| 22                                      | 21                                                                                                                                                                                                                                                                                                                                                                                                                                                                                                                                                                                                                                                                                                                                                                                                                                                                                                                                                                                                                                                                                                                                                                                                                                                                                                                                                                                                                                                                                                                                 | 27.6                            | 24            | 1.5 |    |                                 |                                 |                |   |   |   |   |   |   |   |    |    |    |    |    |    |     |     |    |    |    |    |                                                                                                                                                                                                                                                                                                                                                                                                                                                                                                                                                                                                      |                                 |               |     |   |   |   |   |   |   |     |     |   |    |   |    |    |    |      |     |    |    |    |    |    |    |      |     |    |    |    |   |    |    |      |     |    |    |    |   |    |    |      |     |    |    |    |   |    |    |      |     |    |    |    |   |  |  |  |  |    |    |    |   |  |  |  |  |    |    |    |   |  |  |  |  |                                                                                                                                                                                                                                                                                                                                                                                                                                                                                                                                                                                                                                                                                                                                                                                                                                                                                                                                                                                                                                                                                                                                                                                                                                                                                                                                                                                                                                                                                                                                                                                                                                                                                                                                                                                                                                          |                                 |               |  |  |  |  |                                 |                |  |  |  |  |   |   |   |   |   |   |   |   |   |   |      |   |     |   |   |      |     |   |   |   |      |   |     |   |   |      |     |   |   |   |      |   |     |   |   |      |      |   |   |   |      |    |     |    |   |      |      |   |   |   |      |    |     |    |    |      |      |   |    |    |      |    |     |    |    |      |      |   |    |    |      |    |     |    |    |      |      |   |    |    |      |    |     |    |    |      |      |   |    |    |      |    |     |  |  |  |  |  |    |    |      |    |     |  |  |  |  |  |    |    |      |    |     |  |  |  |  |  |
| 26                                      | 25                                                                                                                                                                                                                                                                                                                                                                                                                                                                                                                                                                                                                                                                                                                                                                                                                                                                                                                                                                                                                                                                                                                                                                                                                                                                                                                                                                                                                                                                                                                                 | 31.6                            | 28            | 1.5 |    |                                 |                                 |                |   |   |   |   |   |   |   |    |    |    |    |    |    |     |     |    |    |    |    |                                                                                                                                                                                                                                                                                                                                                                                                                                                                                                                                                                                                      |                                 |               |     |   |   |   |   |   |   |     |     |   |    |   |    |    |    |      |     |    |    |    |    |    |    |      |     |    |    |    |   |    |    |      |     |    |    |    |   |    |    |      |     |    |    |    |   |    |    |      |     |    |    |    |   |  |  |  |  |    |    |    |   |  |  |  |  |    |    |    |   |  |  |  |  |                                                                                                                                                                                                                                                                                                                                                                                                                                                                                                                                                                                                                                                                                                                                                                                                                                                                                                                                                                                                                                                                                                                                                                                                                                                                                                                                                                                                                                                                                                                                                                                                                                                                                                                                                                                                                                          |                                 |               |  |  |  |  |                                 |                |  |  |  |  |   |   |   |   |   |   |   |   |   |   |      |   |     |   |   |      |     |   |   |   |      |   |     |   |   |      |     |   |   |   |      |   |     |   |   |      |      |   |   |   |      |    |     |    |   |      |      |   |   |   |      |    |     |    |    |      |      |   |    |    |      |    |     |    |    |      |      |   |    |    |      |    |     |    |    |      |      |   |    |    |      |    |     |    |    |      |      |   |    |    |      |    |     |  |  |  |  |  |    |    |      |    |     |  |  |  |  |  |    |    |      |    |     |  |  |  |  |  |
| <b>1mm Pitch Vertical Mounting Type</b> | <p>※Set the stiffener thickness to 0.188 (7.5mil) min.</p> <p style="text-align: right;">Unit : mm</p> <table border="1"> <thead> <tr> <th rowspan="2">Dimension<br/>Number of Contacts</th> <th colspan="2">Standard Type</th> </tr> <tr> <th>A</th> <th>B</th> </tr> </thead> <tbody> <tr><td>6</td><td>5</td><td>7</td></tr> <tr><td>7</td><td>6</td><td>8</td></tr> <tr><td>8</td><td>7</td><td>9</td></tr> <tr><td>16</td><td>15</td><td>17</td></tr> <tr><td>20</td><td>19</td><td>21</td></tr> <tr><td>22</td><td>21</td><td>23</td></tr> <tr><td>24</td><td>23</td><td>25</td></tr> </tbody> </table>                                                                                                                                                                                                                                                                                                                                                                                                                                                                                                                                                                                                                                                                                                                                                                                                                                                                                                                      | Dimension<br>Number of Contacts | Standard Type |     | A  | B                               | 6                               | 5              | 7 | 7 | 6 | 8 | 8 | 7 | 9 | 16 | 15 | 17 | 20 | 19 | 21 | 22  | 21  | 23 | 24 | 23 | 25 | <p>Recommended metal mask thickness : 0.15mm</p> <p style="text-align: right;">Unit : mm</p> <table border="1"> <thead> <tr> <th rowspan="2">Dimension<br/>Number of Contacts</th> <th colspan="2">Standard Type</th> </tr> <tr> <th>A</th> <th>B</th> </tr> </thead> <tbody> <tr><td>6</td><td>8</td><td>5</td></tr> <tr><td>7</td><td>9</td><td>6</td></tr> <tr><td>8</td><td>10</td><td>7</td></tr> <tr><td>16</td><td>18</td><td>15</td></tr> <tr><td>20</td><td>22</td><td>19</td></tr> <tr><td>22</td><td>24</td><td>21</td></tr> <tr><td>24</td><td>26</td><td>23</td></tr> </tbody> </table> | Dimension<br>Number of Contacts | Standard Type |     | A | B | 6 | 8 | 5 | 7 | 9   | 6   | 8 | 10 | 7 | 16 | 18 | 15 | 20   | 22  | 19 | 22 | 24 | 21 | 24 | 26 | 23   |     |    |    |    |   |    |    |      |     |    |    |    |   |    |    |      |     |    |    |    |   |    |    |      |     |    |    |    |   |  |  |  |  |    |    |    |   |  |  |  |  |    |    |    |   |  |  |  |  |                                                                                                                                                                                                                                                                                                                                                                                                                                                                                                                                                                                                                                                                                                                                                                                                                                                                                                                                                                                                                                                                                                                                                                                                                                                                                                                                                                                                                                                                                                                                                                                                                                                                                                                                                                                                                                          |                                 |               |  |  |  |  |                                 |                |  |  |  |  |   |   |   |   |   |   |   |   |   |   |      |   |     |   |   |      |     |   |   |   |      |   |     |   |   |      |     |   |   |   |      |   |     |   |   |      |      |   |   |   |      |    |     |    |   |      |      |   |   |   |      |    |     |    |    |      |      |   |    |    |      |    |     |    |    |      |      |   |    |    |      |    |     |    |    |      |      |   |    |    |      |    |     |    |    |      |      |   |    |    |      |    |     |  |  |  |  |  |    |    |      |    |     |  |  |  |  |  |    |    |      |    |     |  |  |  |  |  |
|                                         | Dimension<br>Number of Contacts                                                                                                                                                                                                                                                                                                                                                                                                                                                                                                                                                                                                                                                                                                                                                                                                                                                                                                                                                                                                                                                                                                                                                                                                                                                                                                                                                                                                                                                                                                    |                                 | Standard Type |     |    |                                 |                                 |                |   |   |   |   |   |   |   |    |    |    |    |    |    |     |     |    |    |    |    |                                                                                                                                                                                                                                                                                                                                                                                                                                                                                                                                                                                                      |                                 |               |     |   |   |   |   |   |   |     |     |   |    |   |    |    |    |      |     |    |    |    |    |    |    |      |     |    |    |    |   |    |    |      |     |    |    |    |   |    |    |      |     |    |    |    |   |    |    |      |     |    |    |    |   |  |  |  |  |    |    |    |   |  |  |  |  |    |    |    |   |  |  |  |  |                                                                                                                                                                                                                                                                                                                                                                                                                                                                                                                                                                                                                                                                                                                                                                                                                                                                                                                                                                                                                                                                                                                                                                                                                                                                                                                                                                                                                                                                                                                                                                                                                                                                                                                                                                                                                                          |                                 |               |  |  |  |  |                                 |                |  |  |  |  |   |   |   |   |   |   |   |   |   |   |      |   |     |   |   |      |     |   |   |   |      |   |     |   |   |      |     |   |   |   |      |   |     |   |   |      |      |   |   |   |      |    |     |    |   |      |      |   |   |   |      |    |     |    |    |      |      |   |    |    |      |    |     |    |    |      |      |   |    |    |      |    |     |    |    |      |      |   |    |    |      |    |     |    |    |      |      |   |    |    |      |    |     |  |  |  |  |  |    |    |      |    |     |  |  |  |  |  |    |    |      |    |     |  |  |  |  |  |
| A                                       |                                                                                                                                                                                                                                                                                                                                                                                                                                                                                                                                                                                                                                                                                                                                                                                                                                                                                                                                                                                                                                                                                                                                                                                                                                                                                                                                                                                                                                                                                                                                    | B                               |               |     |    |                                 |                                 |                |   |   |   |   |   |   |   |    |    |    |    |    |    |     |     |    |    |    |    |                                                                                                                                                                                                                                                                                                                                                                                                                                                                                                                                                                                                      |                                 |               |     |   |   |   |   |   |   |     |     |   |    |   |    |    |    |      |     |    |    |    |    |    |    |      |     |    |    |    |   |    |    |      |     |    |    |    |   |    |    |      |     |    |    |    |   |    |    |      |     |    |    |    |   |  |  |  |  |    |    |    |   |  |  |  |  |    |    |    |   |  |  |  |  |                                                                                                                                                                                                                                                                                                                                                                                                                                                                                                                                                                                                                                                                                                                                                                                                                                                                                                                                                                                                                                                                                                                                                                                                                                                                                                                                                                                                                                                                                                                                                                                                                                                                                                                                                                                                                                          |                                 |               |  |  |  |  |                                 |                |  |  |  |  |   |   |   |   |   |   |   |   |   |   |      |   |     |   |   |      |     |   |   |   |      |   |     |   |   |      |     |   |   |   |      |   |     |   |   |      |      |   |   |   |      |    |     |    |   |      |      |   |   |   |      |    |     |    |    |      |      |   |    |    |      |    |     |    |    |      |      |   |    |    |      |    |     |    |    |      |      |   |    |    |      |    |     |    |    |      |      |   |    |    |      |    |     |  |  |  |  |  |    |    |      |    |     |  |  |  |  |  |    |    |      |    |     |  |  |  |  |  |
| 6                                       | 5                                                                                                                                                                                                                                                                                                                                                                                                                                                                                                                                                                                                                                                                                                                                                                                                                                                                                                                                                                                                                                                                                                                                                                                                                                                                                                                                                                                                                                                                                                                                  | 7                               |               |     |    |                                 |                                 |                |   |   |   |   |   |   |   |    |    |    |    |    |    |     |     |    |    |    |    |                                                                                                                                                                                                                                                                                                                                                                                                                                                                                                                                                                                                      |                                 |               |     |   |   |   |   |   |   |     |     |   |    |   |    |    |    |      |     |    |    |    |    |    |    |      |     |    |    |    |   |    |    |      |     |    |    |    |   |    |    |      |     |    |    |    |   |    |    |      |     |    |    |    |   |  |  |  |  |    |    |    |   |  |  |  |  |    |    |    |   |  |  |  |  |                                                                                                                                                                                                                                                                                                                                                                                                                                                                                                                                                                                                                                                                                                                                                                                                                                                                                                                                                                                                                                                                                                                                                                                                                                                                                                                                                                                                                                                                                                                                                                                                                                                                                                                                                                                                                                          |                                 |               |  |  |  |  |                                 |                |  |  |  |  |   |   |   |   |   |   |   |   |   |   |      |   |     |   |   |      |     |   |   |   |      |   |     |   |   |      |     |   |   |   |      |   |     |   |   |      |      |   |   |   |      |    |     |    |   |      |      |   |   |   |      |    |     |    |    |      |      |   |    |    |      |    |     |    |    |      |      |   |    |    |      |    |     |    |    |      |      |   |    |    |      |    |     |    |    |      |      |   |    |    |      |    |     |  |  |  |  |  |    |    |      |    |     |  |  |  |  |  |    |    |      |    |     |  |  |  |  |  |
| 7                                       | 6                                                                                                                                                                                                                                                                                                                                                                                                                                                                                                                                                                                                                                                                                                                                                                                                                                                                                                                                                                                                                                                                                                                                                                                                                                                                                                                                                                                                                                                                                                                                  | 8                               |               |     |    |                                 |                                 |                |   |   |   |   |   |   |   |    |    |    |    |    |    |     |     |    |    |    |    |                                                                                                                                                                                                                                                                                                                                                                                                                                                                                                                                                                                                      |                                 |               |     |   |   |   |   |   |   |     |     |   |    |   |    |    |    |      |     |    |    |    |    |    |    |      |     |    |    |    |   |    |    |      |     |    |    |    |   |    |    |      |     |    |    |    |   |    |    |      |     |    |    |    |   |  |  |  |  |    |    |    |   |  |  |  |  |    |    |    |   |  |  |  |  |                                                                                                                                                                                                                                                                                                                                                                                                                                                                                                                                                                                                                                                                                                                                                                                                                                                                                                                                                                                                                                                                                                                                                                                                                                                                                                                                                                                                                                                                                                                                                                                                                                                                                                                                                                                                                                          |                                 |               |  |  |  |  |                                 |                |  |  |  |  |   |   |   |   |   |   |   |   |   |   |      |   |     |   |   |      |     |   |   |   |      |   |     |   |   |      |     |   |   |   |      |   |     |   |   |      |      |   |   |   |      |    |     |    |   |      |      |   |   |   |      |    |     |    |    |      |      |   |    |    |      |    |     |    |    |      |      |   |    |    |      |    |     |    |    |      |      |   |    |    |      |    |     |    |    |      |      |   |    |    |      |    |     |  |  |  |  |  |    |    |      |    |     |  |  |  |  |  |    |    |      |    |     |  |  |  |  |  |
| 8                                       | 7                                                                                                                                                                                                                                                                                                                                                                                                                                                                                                                                                                                                                                                                                                                                                                                                                                                                                                                                                                                                                                                                                                                                                                                                                                                                                                                                                                                                                                                                                                                                  | 9                               |               |     |    |                                 |                                 |                |   |   |   |   |   |   |   |    |    |    |    |    |    |     |     |    |    |    |    |                                                                                                                                                                                                                                                                                                                                                                                                                                                                                                                                                                                                      |                                 |               |     |   |   |   |   |   |   |     |     |   |    |   |    |    |    |      |     |    |    |    |    |    |    |      |     |    |    |    |   |    |    |      |     |    |    |    |   |    |    |      |     |    |    |    |   |    |    |      |     |    |    |    |   |  |  |  |  |    |    |    |   |  |  |  |  |    |    |    |   |  |  |  |  |                                                                                                                                                                                                                                                                                                                                                                                                                                                                                                                                                                                                                                                                                                                                                                                                                                                                                                                                                                                                                                                                                                                                                                                                                                                                                                                                                                                                                                                                                                                                                                                                                                                                                                                                                                                                                                          |                                 |               |  |  |  |  |                                 |                |  |  |  |  |   |   |   |   |   |   |   |   |   |   |      |   |     |   |   |      |     |   |   |   |      |   |     |   |   |      |     |   |   |   |      |   |     |   |   |      |      |   |   |   |      |    |     |    |   |      |      |   |   |   |      |    |     |    |    |      |      |   |    |    |      |    |     |    |    |      |      |   |    |    |      |    |     |    |    |      |      |   |    |    |      |    |     |    |    |      |      |   |    |    |      |    |     |  |  |  |  |  |    |    |      |    |     |  |  |  |  |  |    |    |      |    |     |  |  |  |  |  |
| 16                                      | 15                                                                                                                                                                                                                                                                                                                                                                                                                                                                                                                                                                                                                                                                                                                                                                                                                                                                                                                                                                                                                                                                                                                                                                                                                                                                                                                                                                                                                                                                                                                                 | 17                              |               |     |    |                                 |                                 |                |   |   |   |   |   |   |   |    |    |    |    |    |    |     |     |    |    |    |    |                                                                                                                                                                                                                                                                                                                                                                                                                                                                                                                                                                                                      |                                 |               |     |   |   |   |   |   |   |     |     |   |    |   |    |    |    |      |     |    |    |    |    |    |    |      |     |    |    |    |   |    |    |      |     |    |    |    |   |    |    |      |     |    |    |    |   |    |    |      |     |    |    |    |   |  |  |  |  |    |    |    |   |  |  |  |  |    |    |    |   |  |  |  |  |                                                                                                                                                                                                                                                                                                                                                                                                                                                                                                                                                                                                                                                                                                                                                                                                                                                                                                                                                                                                                                                                                                                                                                                                                                                                                                                                                                                                                                                                                                                                                                                                                                                                                                                                                                                                                                          |                                 |               |  |  |  |  |                                 |                |  |  |  |  |   |   |   |   |   |   |   |   |   |   |      |   |     |   |   |      |     |   |   |   |      |   |     |   |   |      |     |   |   |   |      |   |     |   |   |      |      |   |   |   |      |    |     |    |   |      |      |   |   |   |      |    |     |    |    |      |      |   |    |    |      |    |     |    |    |      |      |   |    |    |      |    |     |    |    |      |      |   |    |    |      |    |     |    |    |      |      |   |    |    |      |    |     |  |  |  |  |  |    |    |      |    |     |  |  |  |  |  |    |    |      |    |     |  |  |  |  |  |
| 20                                      | 19                                                                                                                                                                                                                                                                                                                                                                                                                                                                                                                                                                                                                                                                                                                                                                                                                                                                                                                                                                                                                                                                                                                                                                                                                                                                                                                                                                                                                                                                                                                                 | 21                              |               |     |    |                                 |                                 |                |   |   |   |   |   |   |   |    |    |    |    |    |    |     |     |    |    |    |    |                                                                                                                                                                                                                                                                                                                                                                                                                                                                                                                                                                                                      |                                 |               |     |   |   |   |   |   |   |     |     |   |    |   |    |    |    |      |     |    |    |    |    |    |    |      |     |    |    |    |   |    |    |      |     |    |    |    |   |    |    |      |     |    |    |    |   |    |    |      |     |    |    |    |   |  |  |  |  |    |    |    |   |  |  |  |  |    |    |    |   |  |  |  |  |                                                                                                                                                                                                                                                                                                                                                                                                                                                                                                                                                                                                                                                                                                                                                                                                                                                                                                                                                                                                                                                                                                                                                                                                                                                                                                                                                                                                                                                                                                                                                                                                                                                                                                                                                                                                                                          |                                 |               |  |  |  |  |                                 |                |  |  |  |  |   |   |   |   |   |   |   |   |   |   |      |   |     |   |   |      |     |   |   |   |      |   |     |   |   |      |     |   |   |   |      |   |     |   |   |      |      |   |   |   |      |    |     |    |   |      |      |   |   |   |      |    |     |    |    |      |      |   |    |    |      |    |     |    |    |      |      |   |    |    |      |    |     |    |    |      |      |   |    |    |      |    |     |    |    |      |      |   |    |    |      |    |     |  |  |  |  |  |    |    |      |    |     |  |  |  |  |  |    |    |      |    |     |  |  |  |  |  |
| 22                                      | 21                                                                                                                                                                                                                                                                                                                                                                                                                                                                                                                                                                                                                                                                                                                                                                                                                                                                                                                                                                                                                                                                                                                                                                                                                                                                                                                                                                                                                                                                                                                                 | 23                              |               |     |    |                                 |                                 |                |   |   |   |   |   |   |   |    |    |    |    |    |    |     |     |    |    |    |    |                                                                                                                                                                                                                                                                                                                                                                                                                                                                                                                                                                                                      |                                 |               |     |   |   |   |   |   |   |     |     |   |    |   |    |    |    |      |     |    |    |    |    |    |    |      |     |    |    |    |   |    |    |      |     |    |    |    |   |    |    |      |     |    |    |    |   |    |    |      |     |    |    |    |   |  |  |  |  |    |    |    |   |  |  |  |  |    |    |    |   |  |  |  |  |                                                                                                                                                                                                                                                                                                                                                                                                                                                                                                                                                                                                                                                                                                                                                                                                                                                                                                                                                                                                                                                                                                                                                                                                                                                                                                                                                                                                                                                                                                                                                                                                                                                                                                                                                                                                                                          |                                 |               |  |  |  |  |                                 |                |  |  |  |  |   |   |   |   |   |   |   |   |   |   |      |   |     |   |   |      |     |   |   |   |      |   |     |   |   |      |     |   |   |   |      |   |     |   |   |      |      |   |   |   |      |    |     |    |   |      |      |   |   |   |      |    |     |    |    |      |      |   |    |    |      |    |     |    |    |      |      |   |    |    |      |    |     |    |    |      |      |   |    |    |      |    |     |    |    |      |      |   |    |    |      |    |     |  |  |  |  |  |    |    |      |    |     |  |  |  |  |  |    |    |      |    |     |  |  |  |  |  |
| 24                                      | 23                                                                                                                                                                                                                                                                                                                                                                                                                                                                                                                                                                                                                                                                                                                                                                                                                                                                                                                                                                                                                                                                                                                                                                                                                                                                                                                                                                                                                                                                                                                                 | 25                              |               |     |    |                                 |                                 |                |   |   |   |   |   |   |   |    |    |    |    |    |    |     |     |    |    |    |    |                                                                                                                                                                                                                                                                                                                                                                                                                                                                                                                                                                                                      |                                 |               |     |   |   |   |   |   |   |     |     |   |    |   |    |    |    |      |     |    |    |    |    |    |    |      |     |    |    |    |   |    |    |      |     |    |    |    |   |    |    |      |     |    |    |    |   |    |    |      |     |    |    |    |   |  |  |  |  |    |    |    |   |  |  |  |  |    |    |    |   |  |  |  |  |                                                                                                                                                                                                                                                                                                                                                                                                                                                                                                                                                                                                                                                                                                                                                                                                                                                                                                                                                                                                                                                                                                                                                                                                                                                                                                                                                                                                                                                                                                                                                                                                                                                                                                                                                                                                                                          |                                 |               |  |  |  |  |                                 |                |  |  |  |  |   |   |   |   |   |   |   |   |   |   |      |   |     |   |   |      |     |   |   |   |      |   |     |   |   |      |     |   |   |   |      |   |     |   |   |      |      |   |   |   |      |    |     |    |   |      |      |   |   |   |      |    |     |    |    |      |      |   |    |    |      |    |     |    |    |      |      |   |    |    |      |    |     |    |    |      |      |   |    |    |      |    |     |    |    |      |      |   |    |    |      |    |     |  |  |  |  |  |    |    |      |    |     |  |  |  |  |  |    |    |      |    |     |  |  |  |  |  |
| Dimension<br>Number of Contacts         | Standard Type                                                                                                                                                                                                                                                                                                                                                                                                                                                                                                                                                                                                                                                                                                                                                                                                                                                                                                                                                                                                                                                                                                                                                                                                                                                                                                                                                                                                                                                                                                                      |                                 |               |     |    |                                 |                                 |                |   |   |   |   |   |   |   |    |    |    |    |    |    |     |     |    |    |    |    |                                                                                                                                                                                                                                                                                                                                                                                                                                                                                                                                                                                                      |                                 |               |     |   |   |   |   |   |   |     |     |   |    |   |    |    |    |      |     |    |    |    |    |    |    |      |     |    |    |    |   |    |    |      |     |    |    |    |   |    |    |      |     |    |    |    |   |    |    |      |     |    |    |    |   |  |  |  |  |    |    |    |   |  |  |  |  |    |    |    |   |  |  |  |  |                                                                                                                                                                                                                                                                                                                                                                                                                                                                                                                                                                                                                                                                                                                                                                                                                                                                                                                                                                                                                                                                                                                                                                                                                                                                                                                                                                                                                                                                                                                                                                                                                                                                                                                                                                                                                                          |                                 |               |  |  |  |  |                                 |                |  |  |  |  |   |   |   |   |   |   |   |   |   |   |      |   |     |   |   |      |     |   |   |   |      |   |     |   |   |      |     |   |   |   |      |   |     |   |   |      |      |   |   |   |      |    |     |    |   |      |      |   |   |   |      |    |     |    |    |      |      |   |    |    |      |    |     |    |    |      |      |   |    |    |      |    |     |    |    |      |      |   |    |    |      |    |     |    |    |      |      |   |    |    |      |    |     |  |  |  |  |  |    |    |      |    |     |  |  |  |  |  |    |    |      |    |     |  |  |  |  |  |
|                                         | A                                                                                                                                                                                                                                                                                                                                                                                                                                                                                                                                                                                                                                                                                                                                                                                                                                                                                                                                                                                                                                                                                                                                                                                                                                                                                                                                                                                                                                                                                                                                  | B                               |               |     |    |                                 |                                 |                |   |   |   |   |   |   |   |    |    |    |    |    |    |     |     |    |    |    |    |                                                                                                                                                                                                                                                                                                                                                                                                                                                                                                                                                                                                      |                                 |               |     |   |   |   |   |   |   |     |     |   |    |   |    |    |    |      |     |    |    |    |    |    |    |      |     |    |    |    |   |    |    |      |     |    |    |    |   |    |    |      |     |    |    |    |   |    |    |      |     |    |    |    |   |  |  |  |  |    |    |    |   |  |  |  |  |    |    |    |   |  |  |  |  |                                                                                                                                                                                                                                                                                                                                                                                                                                                                                                                                                                                                                                                                                                                                                                                                                                                                                                                                                                                                                                                                                                                                                                                                                                                                                                                                                                                                                                                                                                                                                                                                                                                                                                                                                                                                                                          |                                 |               |  |  |  |  |                                 |                |  |  |  |  |   |   |   |   |   |   |   |   |   |   |      |   |     |   |   |      |     |   |   |   |      |   |     |   |   |      |     |   |   |   |      |   |     |   |   |      |      |   |   |   |      |    |     |    |   |      |      |   |   |   |      |    |     |    |    |      |      |   |    |    |      |    |     |    |    |      |      |   |    |    |      |    |     |    |    |      |      |   |    |    |      |    |     |    |    |      |      |   |    |    |      |    |     |  |  |  |  |  |    |    |      |    |     |  |  |  |  |  |    |    |      |    |     |  |  |  |  |  |
| 6                                       | 8                                                                                                                                                                                                                                                                                                                                                                                                                                                                                                                                                                                                                                                                                                                                                                                                                                                                                                                                                                                                                                                                                                                                                                                                                                                                                                                                                                                                                                                                                                                                  | 5                               |               |     |    |                                 |                                 |                |   |   |   |   |   |   |   |    |    |    |    |    |    |     |     |    |    |    |    |                                                                                                                                                                                                                                                                                                                                                                                                                                                                                                                                                                                                      |                                 |               |     |   |   |   |   |   |   |     |     |   |    |   |    |    |    |      |     |    |    |    |    |    |    |      |     |    |    |    |   |    |    |      |     |    |    |    |   |    |    |      |     |    |    |    |   |    |    |      |     |    |    |    |   |  |  |  |  |    |    |    |   |  |  |  |  |    |    |    |   |  |  |  |  |                                                                                                                                                                                                                                                                                                                                                                                                                                                                                                                                                                                                                                                                                                                                                                                                                                                                                                                                                                                                                                                                                                                                                                                                                                                                                                                                                                                                                                                                                                                                                                                                                                                                                                                                                                                                                                          |                                 |               |  |  |  |  |                                 |                |  |  |  |  |   |   |   |   |   |   |   |   |   |   |      |   |     |   |   |      |     |   |   |   |      |   |     |   |   |      |     |   |   |   |      |   |     |   |   |      |      |   |   |   |      |    |     |    |   |      |      |   |   |   |      |    |     |    |    |      |      |   |    |    |      |    |     |    |    |      |      |   |    |    |      |    |     |    |    |      |      |   |    |    |      |    |     |    |    |      |      |   |    |    |      |    |     |  |  |  |  |  |    |    |      |    |     |  |  |  |  |  |    |    |      |    |     |  |  |  |  |  |
| 7                                       | 9                                                                                                                                                                                                                                                                                                                                                                                                                                                                                                                                                                                                                                                                                                                                                                                                                                                                                                                                                                                                                                                                                                                                                                                                                                                                                                                                                                                                                                                                                                                                  | 6                               |               |     |    |                                 |                                 |                |   |   |   |   |   |   |   |    |    |    |    |    |    |     |     |    |    |    |    |                                                                                                                                                                                                                                                                                                                                                                                                                                                                                                                                                                                                      |                                 |               |     |   |   |   |   |   |   |     |     |   |    |   |    |    |    |      |     |    |    |    |    |    |    |      |     |    |    |    |   |    |    |      |     |    |    |    |   |    |    |      |     |    |    |    |   |    |    |      |     |    |    |    |   |  |  |  |  |    |    |    |   |  |  |  |  |    |    |    |   |  |  |  |  |                                                                                                                                                                                                                                                                                                                                                                                                                                                                                                                                                                                                                                                                                                                                                                                                                                                                                                                                                                                                                                                                                                                                                                                                                                                                                                                                                                                                                                                                                                                                                                                                                                                                                                                                                                                                                                          |                                 |               |  |  |  |  |                                 |                |  |  |  |  |   |   |   |   |   |   |   |   |   |   |      |   |     |   |   |      |     |   |   |   |      |   |     |   |   |      |     |   |   |   |      |   |     |   |   |      |      |   |   |   |      |    |     |    |   |      |      |   |   |   |      |    |     |    |    |      |      |   |    |    |      |    |     |    |    |      |      |   |    |    |      |    |     |    |    |      |      |   |    |    |      |    |     |    |    |      |      |   |    |    |      |    |     |  |  |  |  |  |    |    |      |    |     |  |  |  |  |  |    |    |      |    |     |  |  |  |  |  |
| 8                                       | 10                                                                                                                                                                                                                                                                                                                                                                                                                                                                                                                                                                                                                                                                                                                                                                                                                                                                                                                                                                                                                                                                                                                                                                                                                                                                                                                                                                                                                                                                                                                                 | 7                               |               |     |    |                                 |                                 |                |   |   |   |   |   |   |   |    |    |    |    |    |    |     |     |    |    |    |    |                                                                                                                                                                                                                                                                                                                                                                                                                                                                                                                                                                                                      |                                 |               |     |   |   |   |   |   |   |     |     |   |    |   |    |    |    |      |     |    |    |    |    |    |    |      |     |    |    |    |   |    |    |      |     |    |    |    |   |    |    |      |     |    |    |    |   |    |    |      |     |    |    |    |   |  |  |  |  |    |    |    |   |  |  |  |  |    |    |    |   |  |  |  |  |                                                                                                                                                                                                                                                                                                                                                                                                                                                                                                                                                                                                                                                                                                                                                                                                                                                                                                                                                                                                                                                                                                                                                                                                                                                                                                                                                                                                                                                                                                                                                                                                                                                                                                                                                                                                                                          |                                 |               |  |  |  |  |                                 |                |  |  |  |  |   |   |   |   |   |   |   |   |   |   |      |   |     |   |   |      |     |   |   |   |      |   |     |   |   |      |     |   |   |   |      |   |     |   |   |      |      |   |   |   |      |    |     |    |   |      |      |   |   |   |      |    |     |    |    |      |      |   |    |    |      |    |     |    |    |      |      |   |    |    |      |    |     |    |    |      |      |   |    |    |      |    |     |    |    |      |      |   |    |    |      |    |     |  |  |  |  |  |    |    |      |    |     |  |  |  |  |  |    |    |      |    |     |  |  |  |  |  |
| 16                                      | 18                                                                                                                                                                                                                                                                                                                                                                                                                                                                                                                                                                                                                                                                                                                                                                                                                                                                                                                                                                                                                                                                                                                                                                                                                                                                                                                                                                                                                                                                                                                                 | 15                              |               |     |    |                                 |                                 |                |   |   |   |   |   |   |   |    |    |    |    |    |    |     |     |    |    |    |    |                                                                                                                                                                                                                                                                                                                                                                                                                                                                                                                                                                                                      |                                 |               |     |   |   |   |   |   |   |     |     |   |    |   |    |    |    |      |     |    |    |    |    |    |    |      |     |    |    |    |   |    |    |      |     |    |    |    |   |    |    |      |     |    |    |    |   |    |    |      |     |    |    |    |   |  |  |  |  |    |    |    |   |  |  |  |  |    |    |    |   |  |  |  |  |                                                                                                                                                                                                                                                                                                                                                                                                                                                                                                                                                                                                                                                                                                                                                                                                                                                                                                                                                                                                                                                                                                                                                                                                                                                                                                                                                                                                                                                                                                                                                                                                                                                                                                                                                                                                                                          |                                 |               |  |  |  |  |                                 |                |  |  |  |  |   |   |   |   |   |   |   |   |   |   |      |   |     |   |   |      |     |   |   |   |      |   |     |   |   |      |     |   |   |   |      |   |     |   |   |      |      |   |   |   |      |    |     |    |   |      |      |   |   |   |      |    |     |    |    |      |      |   |    |    |      |    |     |    |    |      |      |   |    |    |      |    |     |    |    |      |      |   |    |    |      |    |     |    |    |      |      |   |    |    |      |    |     |  |  |  |  |  |    |    |      |    |     |  |  |  |  |  |    |    |      |    |     |  |  |  |  |  |
| 20                                      | 22                                                                                                                                                                                                                                                                                                                                                                                                                                                                                                                                                                                                                                                                                                                                                                                                                                                                                                                                                                                                                                                                                                                                                                                                                                                                                                                                                                                                                                                                                                                                 | 19                              |               |     |    |                                 |                                 |                |   |   |   |   |   |   |   |    |    |    |    |    |    |     |     |    |    |    |    |                                                                                                                                                                                                                                                                                                                                                                                                                                                                                                                                                                                                      |                                 |               |     |   |   |   |   |   |   |     |     |   |    |   |    |    |    |      |     |    |    |    |    |    |    |      |     |    |    |    |   |    |    |      |     |    |    |    |   |    |    |      |     |    |    |    |   |    |    |      |     |    |    |    |   |  |  |  |  |    |    |    |   |  |  |  |  |    |    |    |   |  |  |  |  |                                                                                                                                                                                                                                                                                                                                                                                                                                                                                                                                                                                                                                                                                                                                                                                                                                                                                                                                                                                                                                                                                                                                                                                                                                                                                                                                                                                                                                                                                                                                                                                                                                                                                                                                                                                                                                          |                                 |               |  |  |  |  |                                 |                |  |  |  |  |   |   |   |   |   |   |   |   |   |   |      |   |     |   |   |      |     |   |   |   |      |   |     |   |   |      |     |   |   |   |      |   |     |   |   |      |      |   |   |   |      |    |     |    |   |      |      |   |   |   |      |    |     |    |    |      |      |   |    |    |      |    |     |    |    |      |      |   |    |    |      |    |     |    |    |      |      |   |    |    |      |    |     |    |    |      |      |   |    |    |      |    |     |  |  |  |  |  |    |    |      |    |     |  |  |  |  |  |    |    |      |    |     |  |  |  |  |  |
| 22                                      | 24                                                                                                                                                                                                                                                                                                                                                                                                                                                                                                                                                                                                                                                                                                                                                                                                                                                                                                                                                                                                                                                                                                                                                                                                                                                                                                                                                                                                                                                                                                                                 | 21                              |               |     |    |                                 |                                 |                |   |   |   |   |   |   |   |    |    |    |    |    |    |     |     |    |    |    |    |                                                                                                                                                                                                                                                                                                                                                                                                                                                                                                                                                                                                      |                                 |               |     |   |   |   |   |   |   |     |     |   |    |   |    |    |    |      |     |    |    |    |    |    |    |      |     |    |    |    |   |    |    |      |     |    |    |    |   |    |    |      |     |    |    |    |   |    |    |      |     |    |    |    |   |  |  |  |  |    |    |    |   |  |  |  |  |    |    |    |   |  |  |  |  |                                                                                                                                                                                                                                                                                                                                                                                                                                                                                                                                                                                                                                                                                                                                                                                                                                                                                                                                                                                                                                                                                                                                                                                                                                                                                                                                                                                                                                                                                                                                                                                                                                                                                                                                                                                                                                          |                                 |               |  |  |  |  |                                 |                |  |  |  |  |   |   |   |   |   |   |   |   |   |   |      |   |     |   |   |      |     |   |   |   |      |   |     |   |   |      |     |   |   |   |      |   |     |   |   |      |      |   |   |   |      |    |     |    |   |      |      |   |   |   |      |    |     |    |    |      |      |   |    |    |      |    |     |    |    |      |      |   |    |    |      |    |     |    |    |      |      |   |    |    |      |    |     |    |    |      |      |   |    |    |      |    |     |  |  |  |  |  |    |    |      |    |     |  |  |  |  |  |    |    |      |    |     |  |  |  |  |  |
| 24                                      | 26                                                                                                                                                                                                                                                                                                                                                                                                                                                                                                                                                                                                                                                                                                                                                                                                                                                                                                                                                                                                                                                                                                                                                                                                                                                                                                                                                                                                                                                                                                                                 | 23                              |               |     |    |                                 |                                 |                |   |   |   |   |   |   |   |    |    |    |    |    |    |     |     |    |    |    |    |                                                                                                                                                                                                                                                                                                                                                                                                                                                                                                                                                                                                      |                                 |               |     |   |   |   |   |   |   |     |     |   |    |   |    |    |    |      |     |    |    |    |    |    |    |      |     |    |    |    |   |    |    |      |     |    |    |    |   |    |    |      |     |    |    |    |   |    |    |      |     |    |    |    |   |  |  |  |  |    |    |    |   |  |  |  |  |    |    |    |   |  |  |  |  |                                                                                                                                                                                                                                                                                                                                                                                                                                                                                                                                                                                                                                                                                                                                                                                                                                                                                                                                                                                                                                                                                                                                                                                                                                                                                                                                                                                                                                                                                                                                                                                                                                                                                                                                                                                                                                          |                                 |               |  |  |  |  |                                 |                |  |  |  |  |   |   |   |   |   |   |   |   |   |   |      |   |     |   |   |      |     |   |   |   |      |   |     |   |   |      |     |   |   |   |      |   |     |   |   |      |      |   |   |   |      |    |     |    |   |      |      |   |   |   |      |    |     |    |    |      |      |   |    |    |      |    |     |    |    |      |      |   |    |    |      |    |     |    |    |      |      |   |    |    |      |    |     |    |    |      |      |   |    |    |      |    |     |  |  |  |  |  |    |    |      |    |     |  |  |  |  |  |    |    |      |    |     |  |  |  |  |  |

Aug. 1. 2021 Copyright 2021 HIROSE ELECTRIC CO., LTD. All Rights Reserved.

# ◆ Packaging Specification

## Embossed Carrier Tape Dimensions

Horizontal Type (Common to Bottom/Top Contact, 0.5mm/1mm Pitch)

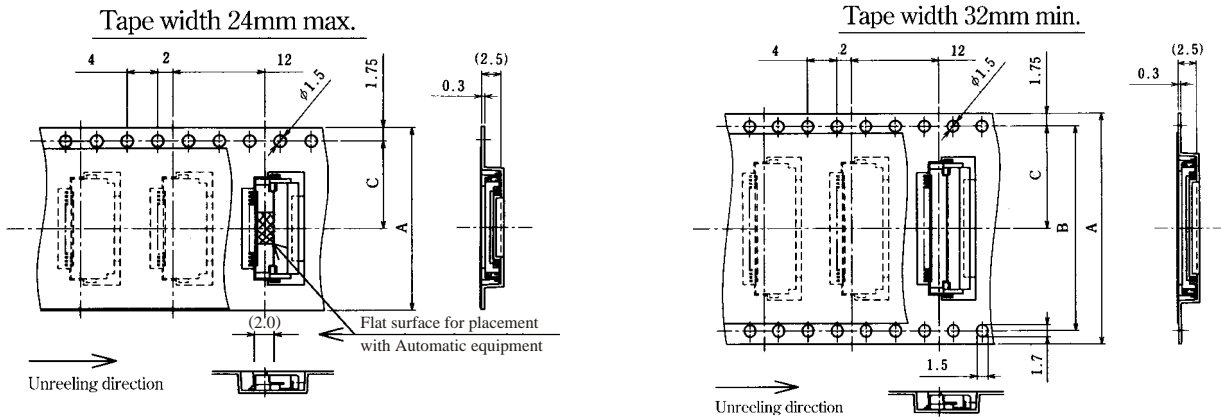

### Reel Dimensions (Common to All Types)

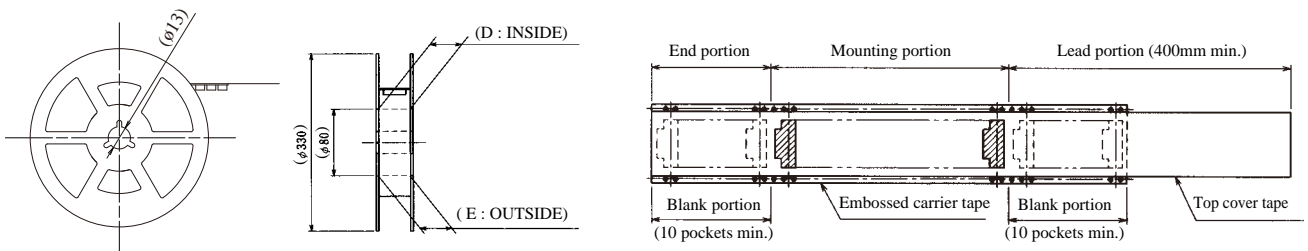

### ● 0.5mm Pitch Bottom/Top Contact Type

Unit : mm

| Dimension<br>Number of Contacts | A  | B | C    | D    | E    |
|---------------------------------|----|---|------|------|------|
| 6                               | 16 | — | 7.5  | 17.4 | 21.4 |
| 8                               | 16 | — | 7.5  | 17.4 | 21.4 |
| 10                              | 16 | — | 7.5  | 17.4 | 21.4 |
| 11                              | 16 | — | 7.5  | 17.4 | 21.4 |
| 12                              | 24 | — | 11.5 | 25.4 | 29.4 |
| 13                              | 24 | — | 11.5 | 25.4 | 29.4 |
| 14                              | 24 | — | 11.5 | 25.4 | 29.4 |
| 15                              | 24 | — | 11.5 | 25.4 | 29.4 |
| 16                              | 24 | — | 11.5 | 25.4 | 29.4 |
| 17                              | 24 | — | 11.5 | 25.4 | 29.4 |
| 18                              | 24 | — | 11.5 | 25.4 | 29.4 |
| 19                              | 24 | — | 11.5 | 25.4 | 29.4 |
| 20                              | 24 | — | 11.5 | 25.4 | 29.4 |
| 22                              | 24 | — | 11.5 | 25.4 | 29.4 |
| 24                              | 24 | — | 11.5 | 25.4 | 29.4 |

| Dimension<br>Number of Contacts | A  | B    | C    | D    | E    |
|---------------------------------|----|------|------|------|------|
| 25                              | 24 | —    | 11.5 | 25.4 | 29.4 |
| 26                              | 24 | —    | 11.5 | 25.4 | 29.4 |
| 28                              | 32 | 28.4 | 14.2 | 33.4 | 37.4 |
| 29                              | 32 | 28.4 | 14.2 | 33.4 | 37.4 |
| 30                              | 32 | 28.4 | 14.2 | 33.4 | 37.4 |
| 32                              | 32 | 28.4 | 14.2 | 33.4 | 37.4 |
| 33                              | 32 | 28.4 | 14.2 | 33.4 | 37.4 |
| 34                              | 32 | 28.4 | 14.2 | 33.4 | 37.4 |
| 35                              | 44 | 40.4 | 20.2 | 45.4 | 49.4 |
| 36                              | 44 | 40.4 | 20.2 | 45.4 | 49.4 |
| 40                              | 44 | 40.4 | 20.2 | 45.4 | 49.4 |
| 42                              | 44 | 40.4 | 20.2 | 45.4 | 49.4 |
| 45                              | 44 | 40.4 | 20.2 | 45.4 | 49.4 |
| 50                              | 44 | 40.4 | 20.2 | 45.4 | 49.4 |
| 53                              | 44 | 40.4 | 20.2 | 45.4 | 49.4 |

### ● 1mm Pitch Bottom Contact Type

Unit : mm

| Dimension<br>Number of Contacts | A  | B    | C    | D    | E    |
|---------------------------------|----|------|------|------|------|
| 5                               | 16 | —    | 7.5  | 17.4 | 21.4 |
| 6                               | 24 | —    | 11.5 | 25.4 | 29.4 |
| 7                               | 24 | —    | 11.5 | 25.4 | 29.4 |
| 8                               | 24 | —    | 11.5 | 25.4 | 29.4 |
| 9                               | 24 | —    | 11.5 | 25.4 | 29.4 |
| 11                              | 24 | —    | 11.5 | 25.4 | 29.4 |
| 12                              | 24 | —    | 11.5 | 25.4 | 29.4 |
| 16                              | 32 | 28.4 | 14.2 | 33.4 | 37.4 |
| 17                              | 44 | 40.4 | 20.2 | 45.4 | 49.4 |
| 22                              | 44 | 40.4 | 20.2 | 45.4 | 49.4 |
| 26                              | 44 | 40.4 | 20.2 | 45.4 | 49.4 |

| Dimension<br>Number of Contacts | A  | B    | C    | D    | E    |
|---------------------------------|----|------|------|------|------|
| 4                               | 16 | —    | 7.5  | 17.4 | 21.4 |
| 6                               | 24 | —    | 11.5 | 25.4 | 29.4 |
| 8                               | 24 | —    | 11.5 | 25.4 | 29.4 |
| 10                              | 24 | —    | 11.5 | 25.4 | 29.4 |
| 11                              | 24 | —    | 11.5 | 25.4 | 29.4 |
| 14                              | 32 | 28.4 | 14.2 | 33.4 | 37.4 |
| 19                              | 44 | 40.4 | 20.2 | 45.4 | 49.4 |
| 24                              | 44 | 40.4 | 20.2 | 45.4 | 49.4 |

**Vertical Mounting Type (Common to 0.5mm/1mm Pitch)**

Tape width 24mm max.

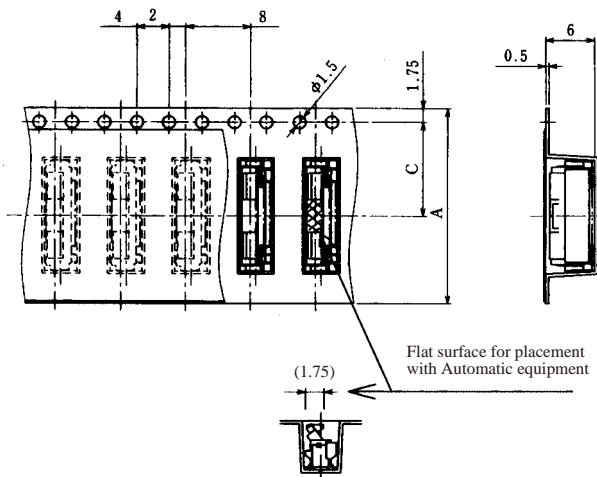

Tape width 32mm min.

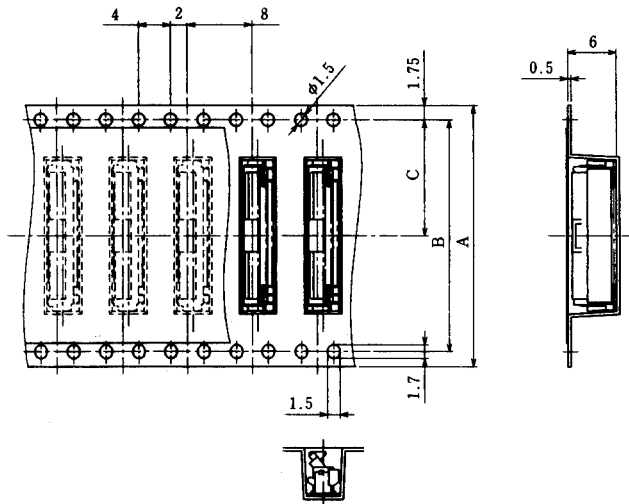

**Reel Dimensions (Common to All Types)**

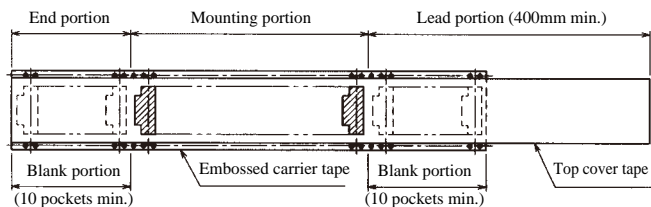
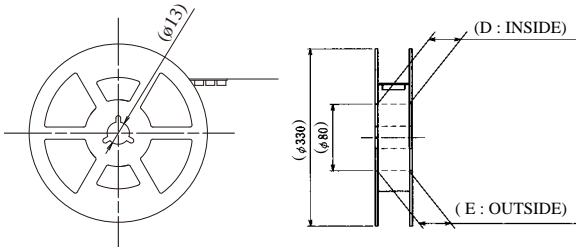

**●0.5mm Pitch Vertical mounting Type**

Unit : mm

| Dimension<br>Number of Contacts | A  | B | C    | D    | E    |
|---------------------------------|----|---|------|------|------|
| 6                               | 16 | — | 7.5  | 17.4 | 21.4 |
| 10                              | 16 | — | 7.5  | 17.4 | 21.4 |
| 12                              | 16 | — | 7.5  | 17.4 | 21.4 |
| 13                              | 24 | — | 11.5 | 25.4 | 29.4 |
| 15                              | 24 | — | 11.5 | 25.4 | 29.4 |
| 16                              | 24 | — | 11.5 | 25.4 | 29.4 |
| 17                              | 24 | — | 11.5 | 25.4 | 29.4 |
| 18                              | 24 | — | 11.5 | 25.4 | 29.4 |
| 20                              | 24 | — | 11.5 | 25.4 | 29.4 |
| 22                              | 24 | — | 11.5 | 25.4 | 29.4 |
| 24                              | 24 | — | 11.5 | 25.4 | 29.4 |

| Dimension<br>Number of Contacts | A  | B    | C    | D    | E    |
|---------------------------------|----|------|------|------|------|
| 26                              | 24 | —    | 11.5 | 25.4 | 29.4 |
| 30                              | 32 | 28.4 | 14.2 | 33.4 | 37.4 |
| 32                              | 32 | 28.4 | 14.2 | 33.4 | 37.4 |
| 33                              | 32 | 28.4 | 14.2 | 33.4 | 37.4 |
| 34                              | 44 | 40.4 | 20.2 | 45.4 | 49.4 |
| 36                              | 44 | 40.4 | 20.2 | 45.4 | 49.4 |
| 40                              | 44 | 40.4 | 20.2 | 45.4 | 49.4 |
| 45                              | 44 | 40.4 | 20.2 | 45.4 | 49.4 |
| 49                              | 44 | 40.4 | 20.2 | 45.4 | 49.4 |
| 50                              | 44 | 40.4 | 20.2 | 45.4 | 49.4 |
| 60                              | 56 | 52.4 | 26.2 | 57.4 | 61.4 |

**●1mm Pitch Vertical mounting Type** Unit : mm

| Dimension<br>Number of Contacts | A  | B    | C    | D    | E    |
|---------------------------------|----|------|------|------|------|
| 6                               | 24 | —    | 11.5 | 25.4 | 29.4 |
| 7                               | 24 | —    | 11.5 | 25.4 | 29.4 |
| 8                               | 24 | —    | 11.5 | 25.4 | 29.4 |
| 16                              | 32 | 28.4 | 14.2 | 33.4 | 37.4 |
| 20                              | 44 | 40.4 | 20.2 | 45.4 | 49.4 |
| 22                              | 44 | 40.4 | 20.2 | 45.4 | 49.4 |
| 24                              | 44 | 40.4 | 20.2 | 45.4 | 49.4 |

## FH12 Series FPC/FFC Construction (Recommended Specifications)

### 1. FFC

### FFC : Flexible Flat Cable

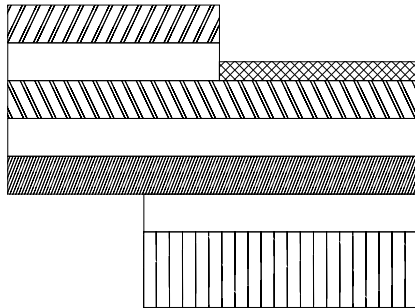

| Material Name                                         | Material                | Thickness (μm) |
|-------------------------------------------------------|-------------------------|----------------|
| Polyester film                                        |                         | (12)           |
| Adhesive                                              | Thermoplastic polyester | (30)           |
| (Nickel under plated / Gold plated), soft copper film |                         | 35             |
| Adhesive                                              | Polyester type          | 30             |
| Polyester                                             |                         | 12             |
| Adhesive                                              | Polyester type          | 30             |
| Stiffener                                             | Polyester type          | 188 (Note)     |
| <b>Total</b>                                          |                         | <b>295</b>     |

\*Real tolerance of thickness dimension is on the order of ±20μm (275 to 315μm)

Note : Use of a thicker FFC results in a stiffer lock action and the lock is more easily released.

A factor that contributes to thicker FFC is the use of 250μm stiffener which is thicker than the standard (188μm) product. This results in a total thickness of 357μm.

When using FFC, control of FFC thickness becomes easy if you indicate to us the thickness of the stiffener.

### 2. FPC

### FPC : Flexible Printed Circuit

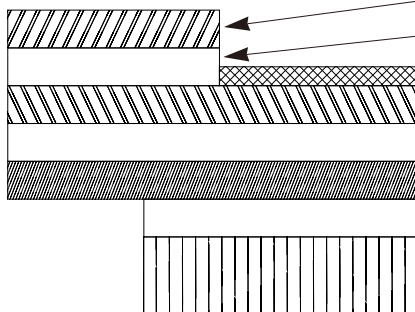

| Material Name                   | Material                                        | Thickness (μm) |
|---------------------------------|-------------------------------------------------|----------------|
| Covering layer film             | Polyimide 1 mil                                 | (25)           |
| Cover adhesive                  |                                                 | (25)           |
| Surface treatment               | Nickel under plated 1to 5μm / Gold plated 0.2μm | 3              |
| Copper foil                     | Cu 1oz                                          | 35             |
| Base adhesive                   | Heat-hardened adhesive                          | 25             |
| Base film                       | Polyimide 1 mil                                 | 25             |
| Reinforcement material adhesive | Heat-hardened adhesive                          | 30             |
| Stiffener                       | Polyimide 7 mil                                 | 175            |
| <b>Total</b>                    |                                                 | <b>293</b>     |

### 3. Precautions

1. This specification is a recommendation for the construction of the FH12 Series FPC and FFC (t=0.3±0.05).
2. For details about the construction, please contact the FPC/FFC manufacturers.

### Recommended Temperature Profile



#### HRS test conditions

- Solder method : Reflow, IR/hot air
- Environment : Room air
- Solder composition : Paste, 96.5%Sn/3%Ag/0.5%Cu (Senju Metal Industry, Co., Ltd.'s Part Number: M705-221CM5-32-10.5)
- Test board : Glass epoxy 40mm×80mm×1.6mm thick
- Land dimensions : Top and bottom contact type 0.3mm×1.3mm Vertical mounting type 0.6mm×1.5mm
- Metal mask : Top and bottom contact type 0.25mm×1.3mm×0.15mm thick Vertical mounting type 0.5mm×1.5mm×0.15mm thick

This temperature profile is based on the above conditions. In individual applications the actual temperature may vary, depending on solder paste type, volume/thickness and board size/thickness. Consult your solder paste and equipment manufacturer for specific recommendations.

**◆ Connector Operating Instructions, precautions and recommendations**  
**● Bottom Contact Type (common for 0.5mm/1mm Pitch)**

| Operation                                                                                                                                                                                                                                                                                                                                                                                                                           | Precautions                                                                                                                                                                                                                                                                                                                                                                                                                                                                                                                                                                                                                                                                                                                                                                                                                                                                                                                                                                                                                                                                                                                                                                                                                                                                                                                                                                                                                                                               |
|-------------------------------------------------------------------------------------------------------------------------------------------------------------------------------------------------------------------------------------------------------------------------------------------------------------------------------------------------------------------------------------------------------------------------------------|---------------------------------------------------------------------------------------------------------------------------------------------------------------------------------------------------------------------------------------------------------------------------------------------------------------------------------------------------------------------------------------------------------------------------------------------------------------------------------------------------------------------------------------------------------------------------------------------------------------------------------------------------------------------------------------------------------------------------------------------------------------------------------------------------------------------------------------------------------------------------------------------------------------------------------------------------------------------------------------------------------------------------------------------------------------------------------------------------------------------------------------------------------------------------------------------------------------------------------------------------------------------------------------------------------------------------------------------------------------------------------------------------------------------------------------------------------------------------|
| <p><b>1. FPC/FFC Termination procedure. Connector installed on the board.</b></p> <p>1) Lift up the actuator. Use thumb or index finger.</p>  <p>2) Fully insert the FPC/FFC parallel to mounting surface, with the exposed conductive traces facing down.</p>  | <p>1) Avoid grasping the actuator with two fingers or lifting the actuator with fingernail.</p>  <p>2) Do not use a thin tool such as the tip of a screwdriver to release the lock lever. Doing so will cause deformation of the contacts.</p>  <p>3) Do not apply force in the direction of arrows A, B, or C while the lock lever is open. Doing so will cause the lock lever to become disengaged, or will damage the hook portion of the connector body.</p>  <p>4) When inserting the FPC/FFC, do not forcefully rub against the surface beneath the connector insertion slot. Doing so will result in the FPC/FFC forcefully striking the contacts and this will cause contact deformation, peeling of the FPC/FFC conductors, and other irregularities.</p>  <p>5) Insert the FPC/FFC at the proper position of the connector insertion slot, and insert perpendicularly with respect to the connector. Improper insertion will cause continuity problems, disengagement of the lock lever, and damage to the hook portion.</p>  |

Aug. 1. 2021 Copyright 2021 HIROSE ELECTRIC CO., LTD. All Rights Reserved.

● Bottom Contact Type (common for 0.5mm/1mm Pitch)

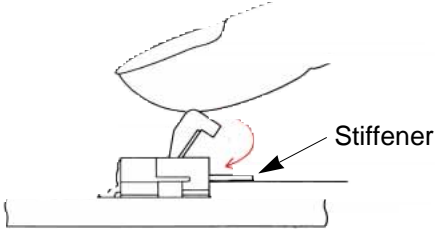
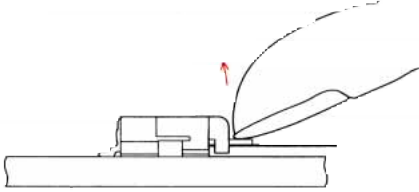
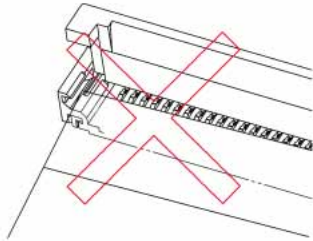
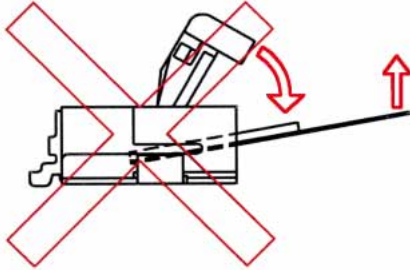
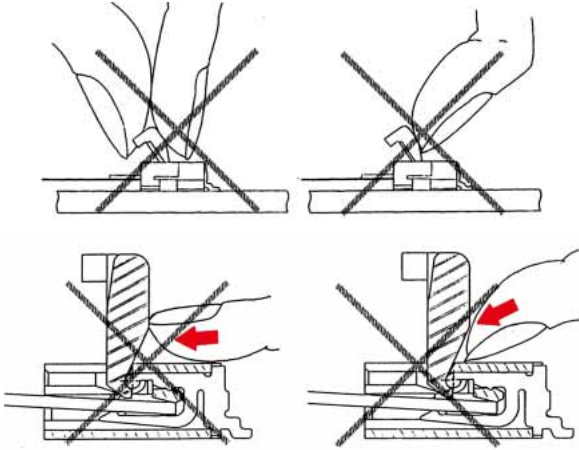
| Operation                                                                                                                                                                                                                                                                                                                                                                                                                                                                                                          | Precautions                                                                                                                                                                                                                                                                                                                                                                                                                                                                                                                                                                                                                                                                                                                                                                                                                                                                                                                                                                                                                                                                                                                       |
|--------------------------------------------------------------------------------------------------------------------------------------------------------------------------------------------------------------------------------------------------------------------------------------------------------------------------------------------------------------------------------------------------------------------------------------------------------------------------------------------------------------------|-----------------------------------------------------------------------------------------------------------------------------------------------------------------------------------------------------------------------------------------------------------------------------------------------------------------------------------------------------------------------------------------------------------------------------------------------------------------------------------------------------------------------------------------------------------------------------------------------------------------------------------------------------------------------------------------------------------------------------------------------------------------------------------------------------------------------------------------------------------------------------------------------------------------------------------------------------------------------------------------------------------------------------------------------------------------------------------------------------------------------------------|
| <p>3) Rotate down the actuator until firmly closed. It is critical that the inserted FPC/FFC is not moved and remains fully inserted. Should the FPC/FFC be moved, open the actuator and repeat the process, starting with Step 1.</p>  <p><b>2. FPC/FFC Removal</b></p> <p>1) Lift up the actuator.<br/>2) Carefully remove the FPC/FFC.</p>  | <p>6) Partial insertion of the FPC/FFC, offset insertion, and diagonal insertion will result in an unfavorable engagement of the lock lever in which the lock lever is raised. To correct this, first remove the FPC/FFC and then reinsert it. Forcing the lock will damage the connector.</p>  <p>7) When locking, handle the FPC/FFC so that a load is not applied to the FPC/FFC as would occur by pulling the FPC/FFC, or lifting it, etc. When a load is applied in the opposite direction to the rotational movement of the lock, an excessive load will be applied and this will cause connector damage.</p>  <p>8) At the time of lock operation, application of force such as that indicated by the arrows in the diagrams below will cause the lock lever to disengage. When the lock lever has become disengaged, please exchange the entire connector.</p>  |

Aug. 1. 2021 Copyright 2021 HIROSE ELECTRIC CO., LTD. All Rights Reserved.

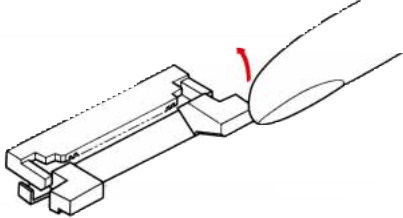
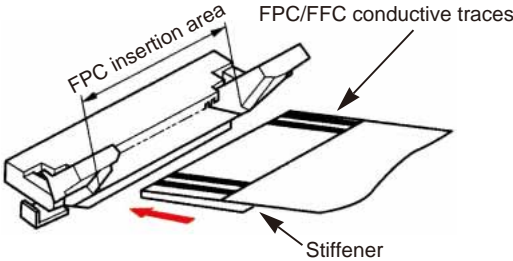
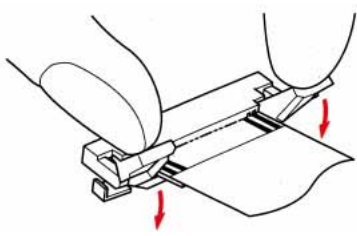
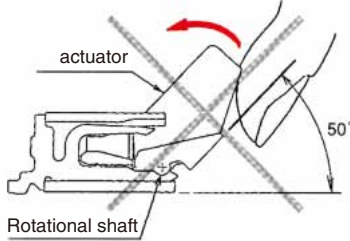
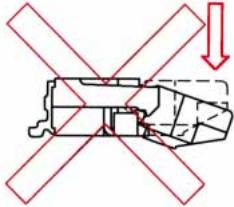
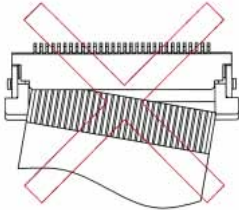
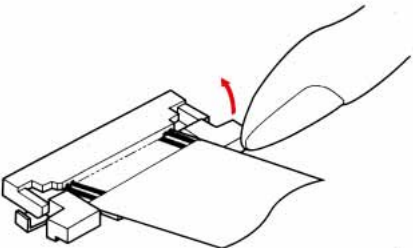
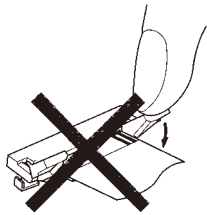

## ●Top Contact Type

| Operation                                                                                                                                                                                                                                                                                                                                                                                                                                                                                                                                                                                                                                                                                                                                                         | Precautions                                                                                                                                                                                                                                                                                                                                                                                                                                                                                                                                                                                                                                                                                                                                                                                                                                                                                                                                                                     |
|-------------------------------------------------------------------------------------------------------------------------------------------------------------------------------------------------------------------------------------------------------------------------------------------------------------------------------------------------------------------------------------------------------------------------------------------------------------------------------------------------------------------------------------------------------------------------------------------------------------------------------------------------------------------------------------------------------------------------------------------------------------------|---------------------------------------------------------------------------------------------------------------------------------------------------------------------------------------------------------------------------------------------------------------------------------------------------------------------------------------------------------------------------------------------------------------------------------------------------------------------------------------------------------------------------------------------------------------------------------------------------------------------------------------------------------------------------------------------------------------------------------------------------------------------------------------------------------------------------------------------------------------------------------------------------------------------------------------------------------------------------------|
| <p><b>1. FPC/FFC Termination procedure. Connector installed on the board.</b></p> <p>1) Lift up the actuator. Use thumb or index finger.</p>  <p>2) Fully insert the FPC/FFC parallel to mounting surface, with the exposed conductive traces facing UP.</p>  <p>3) Rotate down the actuator until firmly closed. It is critical that the inserted FPC/FFC is not moved and remains fully inserted. Should the FPC/FFC be moved, open the actuator and repeat the process, starting with Step 1 above.</p>  | <p>1) Avoid further lifting of the actuator once the lock has been released. Doing so will cause the lock lever to separate from the rotational shaft, and the lock lever will become disengaged or the hook portion of the connector body will be damaged.</p>  <p>2) Avoid further pressing of the lock portion from the locked condition when the FPC/FFC has not yet been inserted. Doing so will cause the lock lever to become disengaged from the rotational shaft, and the hook portion of the connector body will be damaged.</p>  <p>3) Do not insert the FPC/FFC diagonally. Doing so will result in the corners of the FPC/FFC catching on the contacts and will cause deformation of the contacts.</p>  |
| <p><b>2. FPC/FFC Removal</b></p> <p>1) Lift up the actuator.</p> <p>2) Carefully remove the FPC/FFC.</p>                                                                                                                                                                                                                                                                                                                                                                                                                                                                                                                                                                       | <p>4) When closing down the actuator apply equal pressure to both sides of the actuator.</p>                                                                                                                                                                                                                                                                                                                                                                                                                                                                                                                                                                                                                                                                                                                                                                                               |

● Vertical Mounting type (common for 0.5mm/1mm pitch)

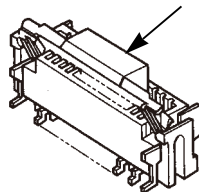
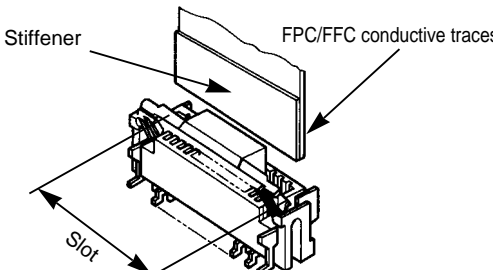
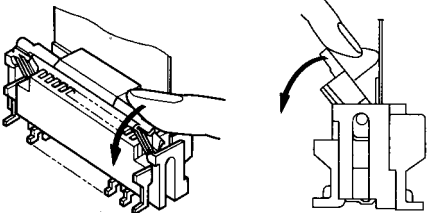
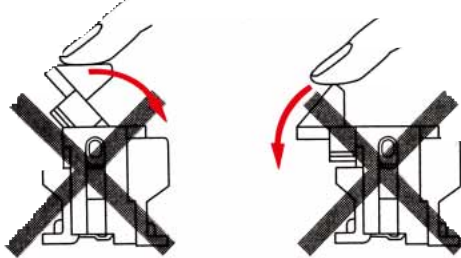
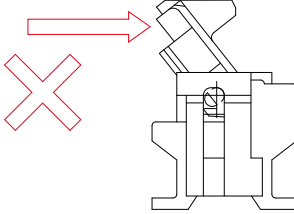
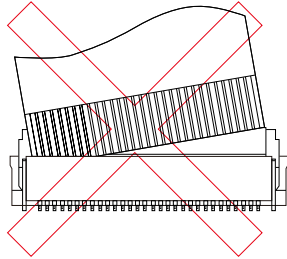
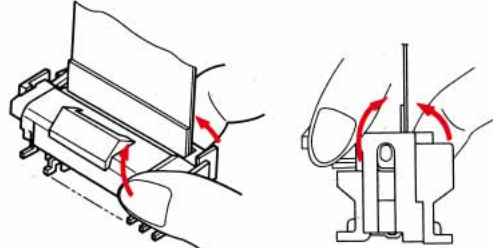
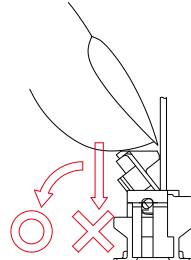
| Operation                                                                                                                                                                                                                                                                                                                                                                                                                                                                                                                                                                                                                                                                                                 | Precautions                                                                                                                                                                                                                                                                                                                                                                                                                                                                                                                                                                                                                                                         |
|-----------------------------------------------------------------------------------------------------------------------------------------------------------------------------------------------------------------------------------------------------------------------------------------------------------------------------------------------------------------------------------------------------------------------------------------------------------------------------------------------------------------------------------------------------------------------------------------------------------------------------------------------------------------------------------------------------------|---------------------------------------------------------------------------------------------------------------------------------------------------------------------------------------------------------------------------------------------------------------------------------------------------------------------------------------------------------------------------------------------------------------------------------------------------------------------------------------------------------------------------------------------------------------------------------------------------------------------------------------------------------------------|
| <p><b>1. FPC/FFC Termination procedure. Connector installed on the board.</b></p> <p>1) Verify that the actuator is positioned upright. If the actuator has rotated to the side, carefully rotate it upright. Actuator upright</p>  <p>2) Insert the FPC/FFC vertically in the connector slot assuring that the conductive traces of the FPC/FFC are facing away from the actuator.</p>  <p>3) Press down the actuator in the direction shown.</p>  | <p>1) Avoid forcing the actuator up or down without the FPC/FFC inserted.</p>  <p>2) Do not attempt to open or over rotate an already released actuator (refer to the diagram below). These actions may damage the actuator.</p>  <p>3) Do not insert the FPC/FFC diagonally. Doing so will result in the corners of the FPC/FFC catching on the contacts and will cause deformation of the contacts.</p>  |
| <p><b>2. FPC/FFC Removal</b></p> <p>Rotate the actuator upward and withdraw the FPC/FFC.</p>                                                                                                                                                                                                                                                                                                                                                                                                                                                                                                                           | <p>4) Do not press down vertically on the actuator when the FPC/FFC already inserted, it needs to be rotated to engage the lock. Refer to the diagram below. Doing so may cause actuator failure.</p>                                                                                                                                                                                                                                                                                                                                                                          |

Aug.1.2021 Copyright 2021 HIROSE ELECTRIC CO., LTD. All Rights Reserved.



**USA:**

**HIROSE ELECTRIC (U.S.A.), INC. HEADQUARTERS CHICAGO OFFICE**  
2300 Warrenville Road, Suite 150,  
Downers Grove, IL 60515  
Phone : +1-630-282-6700  
<http://www.hirose.com/us/>

**USA:**

**HIROSE ELECTRIC (U.S.A.), INC. SAN JOSE OFFICE**  
2841 Junction Ave, Suite 200  
San Jose, CA. 95134  
Phone : +1-408-253-9640  
Fax : +1-408-253-9641  
<http://www.hirose.com/us/>

**USA:**

**HIROSE ELECTRIC (U.S.A.), INC. DETROIT OFFICE (AUTOMOTIVE)**  
17197 N. Laurel Park Drive, Suite 253,  
Livonia, MI 48152  
Phone : +1-734-542-9963  
Fax : +1-734-542-9964  
<http://www.hirose.com/us/>

**THE NETHERLANDS:**

**HIROSE ELECTRIC EUROPE B.V.**  
Hogehillweg #8 1101 CC Amsterdam Z-O  
Phone : +31-20-6557460  
Fax : +31-20-6557469  
<http://www.hirose.com/eu/>

**GERMANY:**

**HIROSE ELECTRIC EUROPE B.V. GERMAN BRANCH**  
Schoenbergstr. 20, 73760 ostfildern  
Phone : +49-711-456002-1  
Fax : +49-711-456002-299  
<http://www.hirose.com/eu/>

**GERMANY:**

**HIROSE ELECTRIC EUROPE B.V. NUREMBERG OFFICE**  
Neumeyerstrasse 22-26, 90411 Nurnberg  
Phone : +49-911 32 68 89 63  
Fax : +49-911 32 68 89 69  
<http://www.hirose.com/eu/>

**GERMANY:**

**HIROSE ELECTRIC EUROPE B.V. HANOVER OFFICE**  
Bayernstr. 3, Haus C 30855 Langenhagen, Germany  
Phone : +49-511 97 82 61 30  
Fax : +49-511 97 82 61 35  
<http://www.hirose.com/eu/>

**FRANCE:**

**HIROSE ELECTRIC EUROPE B.V. PARIS OFFICE**  
Regus La Garenne Colombes, Place de La Belgique,  
71 Boulevard National La Garenne Colombes, 92250, France  
Phone : +33 (0) 1 7082 3170  
Fax : +33 (1) 7082 3101  
<http://www.hirose.com/eu/>

**UNITED KINGDOM:**

**HIROSE ELECTRIC EUROPE BV (UK BRANCH)**  
4 Newton Court, Kelvin Drive, Knowlhill,  
Milton Keynes, MK5 8NH  
Phone : +44-1908 202050  
Fax : +44-1908 202058  
<http://www.hirose.com/eu/>

**CHINA:**

**HIROSE ELECTRIC (SHANGHAI) CO., LTD.**  
1601, Henderson Metropolitan, NO.300, East Nanjing  
Road, Huangpu District, Shanghai, China 200001  
Phone : +86-21-6391-3355  
Fax : +86-21-6391-3335  
<http://www.hirose.com/cn/>

**CHINA:**

**HIROSE ELECTRIC (SHANGHAI) CO.,LTD. BEIJING BRANCH**  
A1001, Ocean International Center, Building 56# East 4th  
Ring Middle Road, ChaoYang District, Beijing, 100025  
Phone : +86-10-5165-9332  
Fax : +86-10-5908-1381  
<http://www.hirose.com/cn/>

**CHINA:**

**HIROSE ELECTRIC TECHNOLOGIES (SHENZHEN) CO., LTD.**  
Room 09-13, 19/F, Office Tower Shun Hing Square, Di Wang Commercial Centre,  
5002 Shen Nan Dong Road, Shenzhen City, Guangdong Province, 518008  
Phone : +86-755-8207-0851  
Fax : +86-755-8207-0873  
<http://www.hirose.com/cn/>

**HONG KONG:**

**HIROSE ELECTRIC HONGKONG TRADING CO., LTD.**  
Room 1001, West Wing, Tsim Sha Tsui Centre, 66  
Mody Road, Tsim Sha Tsui East, Kowloon, Hong Kong  
Phone : +852-2803-5338  
Fax : +852-2591-6560  
<http://www.hirose.com/hk/>

**TAIWAN:**

**HIROSE ELECTRIC TAIWAN CO., LTD.**  
103 8F, No.87, Zhengzhou Rd., Taipei  
Phone : +886-2-2555-7377  
Fax : +886-2-2555-7350  
<http://www.hirose.com/tw/>

**KOREA:**

**HIROSE KOREA CO.,LTD.**  
250, Huimanggongwon-ro, Siheung-si,  
Gyeonggi-do, Korea, 15083  
Phone : +82-31-496-7000 or 7124  
Fax : +82-31-496-7100  
<http://www.hirose.co.kr/>

**SINGAPORE:**

**HIROSE ELECTRIC SINGAPORE PTE. LTD.**  
10 Anson Road #26-16, International Plaza  
079903, Singapore  
Phone : +65-6324-6113  
Fax : +65-6324-6123  
<http://www.hirose.com/sg/>

**INDIA:**

**HIROSE ELECTRIC SINGAPORE PTE. LTD. DELHI LIAISON OFFICE**  
Office NO.552, Regus-Green Boulevard, Level5, Tower C,  
Sec62, Plot B-9A, Block B, Noida, 201301, Uttar Pradesh, India  
Phone : +91-12-660-8018  
Fax : +91-120-4804949  
<http://www.hirose.com/sg/>

**INDIA:**

**HIROSE ELECTRIC SINGAPORE PTE. LTD. BANGALORE LIAISON OFFICE**  
Unit No-403, 4th Floor, No-84, Barton Centre, Mahatma  
Gandhi (MG) Road, Bangalore 560 001, Karnataka, India  
Phone : +91-80-4120 1907  
Fax : +91-80-4120 9908  
<http://www.hirose.com/sg/>

**MALAYSIA:**

**PENANG REPRESENTATIVE OFFICE**  
1-21-01, Suntech @ Penang Cybercity (1164), Lintang  
Mayang Pasir 3,11950, Bayan Baru, Penang, Malaysia.  
Phone : +604-619-2564  
Fax : +604-619-2574  
<http://www.hirose.com/sg/>

**THAILAND:**

**BANGKOK OFFICE (REPRESENTATIVE OFFICE)**  
Unit 4703, 47th FL., 1 Empire Tower, South Sathorn  
Road, Yannawa, Sathorn, Bangkok 10120 Thailand  
Phone : +66-2-686-1255  
Fax : +66-2-686-3433  
<http://www.hirose.com/sg/>

**HIROSE ELECTRIC CO.,LTD.**

2-6-3, Nakagawa Chuoh, Tsuzuki-Ku, Yokohama-Shi 224-8540, JAPAN  
TEL: +81-45-620-3526 Fax: +81-45-591-3726  
<http://www.hirose.com>  
<http://www.hirose-connectors.com>

# Mouser Electronics

Authorized Distributor

Click to View Pricing, Inventory, Delivery & Lifecycle Information:

## [Hirose Electric:](#)

[FH12-10S-0.5SV\(55\)](#) [FH12-12S-0.5SV\(55\)](#) [FH12-15S-0.5SV\(55\)](#) [FH12-16S-0.5SV\(55\)](#) [FH12-20S-0.5SV\(55\)](#) [FH12-22S-0.5SV\(55\)](#) [FH12-24S-0.5SV\(55\)](#) [FH12-26S-0.5SV\(55\)](#) [FH12-30S-0.5SV\(55\)](#) [FH12-33S-0.5SV\(55\)](#) [FH12-36S-0.5SV\(55\)](#) [FH12-40S-0.5SV\(55\)](#) [FH12-45S-0.5SV\(55\)](#) [FH12-50S-0.5SV\(55\)](#) [FH12-8S-1SV\(55\)](#) [FH12-16S-1SV\(55\)](#) [FH12-60S-0.5SV\(55\)](#) [FH12-18S-0.5SV\(55\)](#) [FH12-24S-1SV\(55\)](#) [FH12-32S-0.5SV\(55\)](#) [FH12-6S-1SV\(55\)](#) [FH12-20S-1SV\(55\)](#) [FH12-17S-0.5SV\(55\)](#) [FH12-49S-0.5SV\(55\)](#) [FH12-13S-0.5SV\(55\)](#) [FH12-22S-1SV\(55\)](#) [FH12-7S-1SV\(55\)](#) [FH12-34S-0.5SV\(55\)](#) [FH12-30S-0.5SH\(59\)](#) [FH12-50S-0.5SH\(66\)](#) [FH12A-10\(4\)SB-1SH\(55\)](#) [FH12A-16S-1SH\(55\)](#) [FH12G-50S-0.5SH\(55\)](#) [FH12S-26S-1SH\(55\)](#) [FH12-22S-0.5SH\(59\)](#) [FH12-10S-0.5SV\(1\)\(98\)](#) [FH12-15S-0.5SV\(1\)\(98\)](#) [FH12-16S-0.5SV\(1\)\(98\)](#) [FH12-20S-0.5SV\(1\)\(98\)](#) [FH12-24S-0.5SV\(1\)\(98\)](#) [FH12-30S-0.5SV\(1\)\(98\)](#) [FH12-34S-0.5SV\(1\)\(98\)](#) [FH12-40S-0.5SV\(1\)\(98\)](#) [FH12-60S-0.5SV\(1\)\(98\)](#) [FH12-49S-0.5SV\(1\)\(98\)](#) [FH12-12S-0.5SV\(1\)\(98\)](#) [FH12-18S-0.5SV\(1\)\(98\)](#) [FH12-50S-0.5SV\(1\)\(98\)](#) [FH12-26S-0.5SV\(1\)\(98\)](#) [FH12-22S-0.5SV\(1\)\(98\)](#) [FH12-17S-0.5SV\(1\)\(98\)](#) [FH12-13S-0.5SV\(1\)\(98\)](#) [FH12-33S-0.5SV\(1\)\(98\)](#) [FH12-36S-0.5SV\(1\)\(98\)](#) [FH12-32S-0.5SV\(1\)\(98\)](#) [FH12-45S-0.5SV\(1\)\(98\)](#)