

N type Coaxial Connectors

N Series

■ Features

1. 50 ohms wide varieties standard connectors
2. Screw on locking
3. Applicable cable : RG cable, JIS cable
4. Applicable standard : MIL-C-39012/MIL STD 348-304

■ Functional diagram

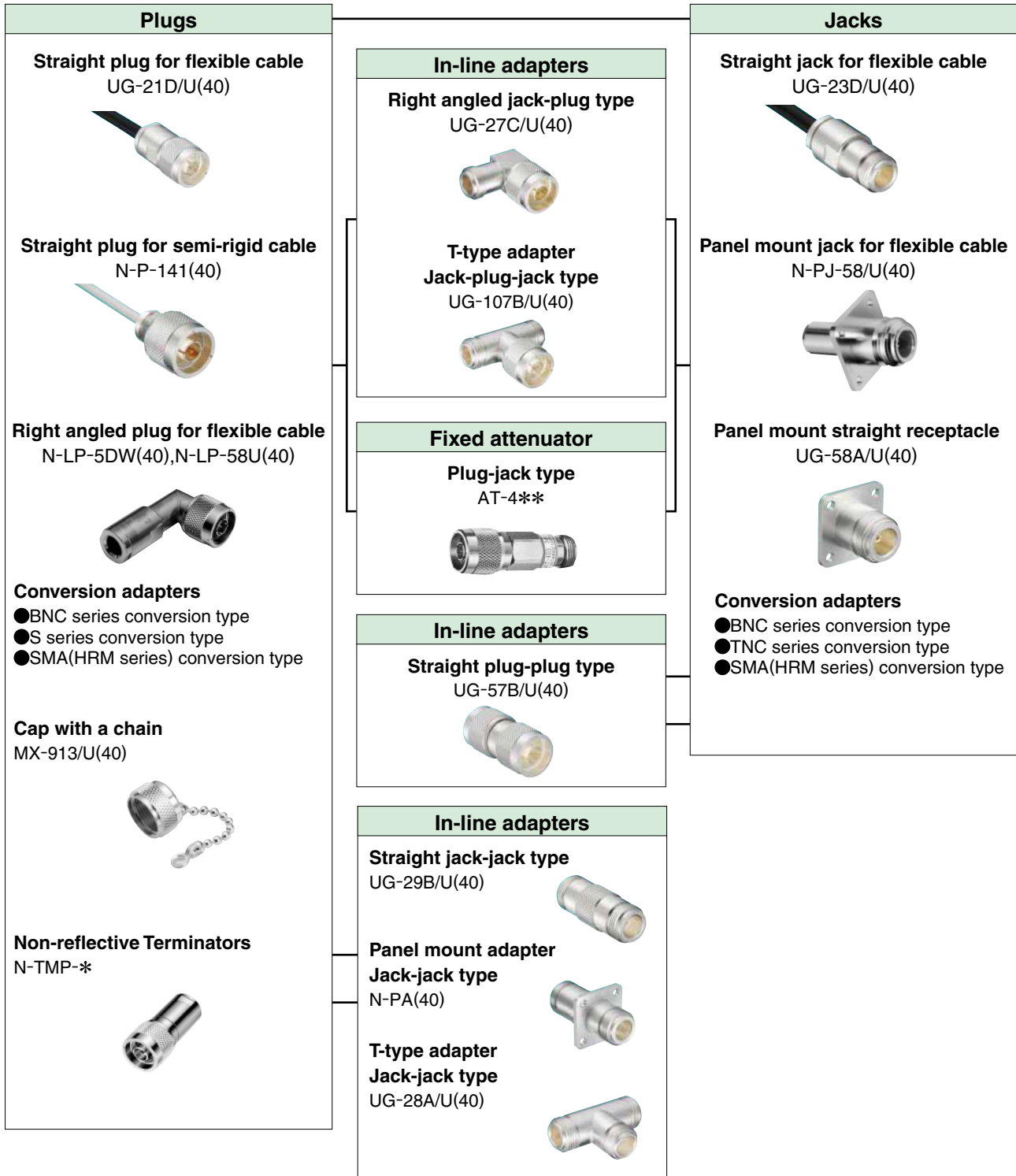

Product Specifications

Ratings	Nominal characteristic impedance Frequency range	50Ω DC to 2GHz	Operating temperature range Operating humidity	-30°C to +60°C 95%RH max.
---------	---	-------------------	---	------------------------------

Item	Specification	Conditions
1. Contact resistance	3mΩ max.	100mA max.
2. Insulation resistance	1000MΩ min.	500V DC
3. Withstanding voltage	No flashover or insulation breakdown.	1500V AC / 1 minute
4. V.S.W.R.*	1.2 max.	Up to 2GHz
5. Durability (mating / un-mating, with corresponding plug)	10mΩ max.	500 cycles
6. Vibration	No electrical discontinuity of 1μs min.	Frequency : 10 to 500Hz, single amplitude of 0.75mm, acceleration of 98m/s ² , for 10 cycles in the direction of each of the 3 axis.
7. Shock	No damage, cracks or parts dislocation.	Acceleration of 490m/s ² , 11ms duration, sine half-wave waveform, 3 cycles in each of 3 axes.
8. Humidity (Steady state)	No damage, cracks or parts dislocation.	96 hours at temperature of 40°C and humidity of 80% to 96%.
9. Temperature cycle	No damage, cracks or parts dislocation.	Temperature : -55°C→+25 to +65°C→+85°C→+5 to +35°C Time : 30min.→ 5min. →30min.→ 5min. 5 cycles
10. Salt spray	No excessive corrosion	5% salt water solution, 48 hours

*V.S.W.R. Measurement System

The above V.S.W.R. standard values were measured using the measurement connection as shown below.

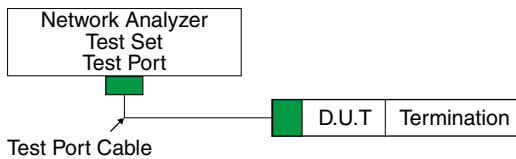

Note 1 : Connectors with cable are measured with 10cm of suitable cable attached at both ends.

Material / Finish

Part	Material	Finish	Remark
Shell	Brass	Silver plated/Nickel plated	——
Male contact	Brass	Silver plated/Gold plated	——
Female contact	Beryllium copper	Silver plated/Gold plated	——
Insulator	Tetrafluoride resin	——	Flame retardant
Packing	Silicone rubber	——	Flame retardant

Product Number Structure

Refer to the chart below when determining the product specifications from the product number.

Please select from the product numbers listed in this catalog when placing orders.

●Standard

N - L P - 5DW

① ② ③ ④

① Series name : N	③ Connector type P : Plug J : Jack PJ : Panel jack R : Receptacle A : Adapter PA : Panel adapter
② Connector style Blank : Straight type L : L angle type T : T angle type	④ Applicable cable

●Product with MIL standard

UG-21 D /U

① ② ③ ①

① High frequency coaxial connectors
② Product identification number
③ Improved sign

Straight Plug

Flexible cable type

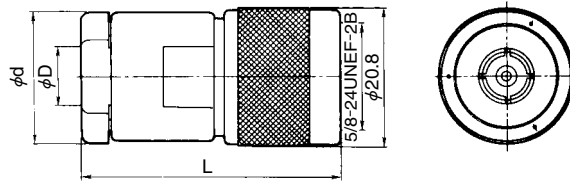

Unit : mm

Part No.	HRS No.	Packaging	Applicable cable	ϕD	ϕd	L
UG-21D/U(40)	301-0003-0 40	1	RG-8/U, RG-9/U	11.1	19.0	38.0
JUG-536/U(40)	301-0001-4 40		RG-58/U	5.4	19.0	38.0
N-P-3DV(40)	301-0078-9 40		3D-2V	6.3	12.7	35.0
N-P-5DV(40)	301-0120-3 40		5D-2V	8.6	18.0	45.5
N-P-5DW(32)	301-0199-3 32		5D-2W	9.3	18.0	46.0
N-P-5DFB(40)	301-0205-4 40		5D-FB	8.6	18.0	46.0
N-P-10DFB(31)	301-0206-7 31		10D-FB	14.5	23.0	55.0

Semi rigid cable type

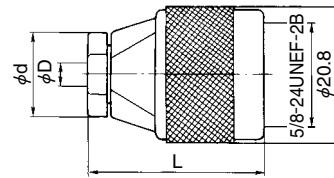

Unit : mm

Part No.	HRS No.	Packaging	Applicable cable	ϕD	ϕd	L
N-P-141(40)	301-0162-3 40	1	UT-141A	3.63	13	27.3
N-P-141-2(A)(40)	301-0262-8 40		UT-141A	3.63	5	25.7
N-P-250(A)(41)	301-0261-5 41		UT-250	6.5	14	34.9

Right angle plug

Flexible cable type

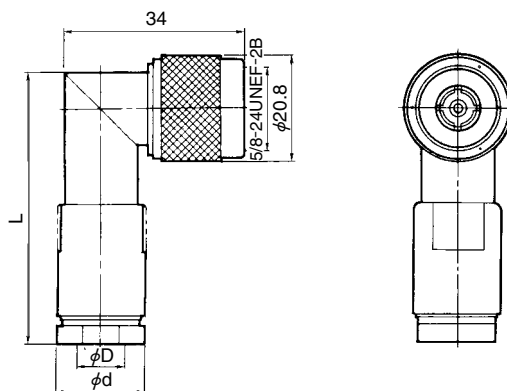

Unit : mm

Part No.	HRS No.	Packaging	Applicable cable	ϕD	ϕd	L	Remarks
N-LP-5DW(40)	301-0007-0 40	1	5D-2W	9.3	17.5	52.4	Nickel-plated except for center conductor
N-LP-58U(40)	301-0076-3 40		RG-58/U	5.3	15.5	44.0	

■ Straight jack

● Flexible cable type

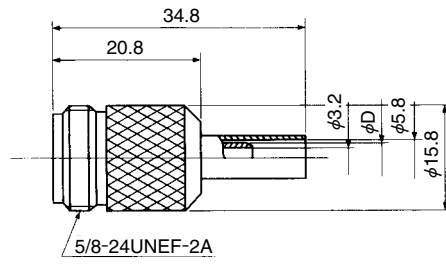

Unit : mm

Part No.	HRS No.	Packaging	Applicable cable	φD
N-J-3DV(40)	301-0180-5 40	1	3D-2V	5.1

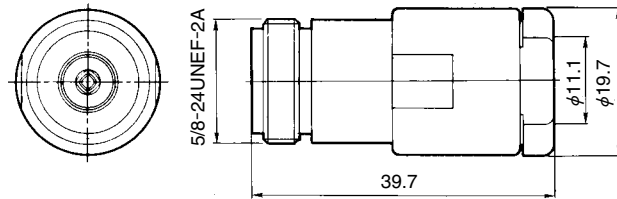

Part No.	HRS No.	Packaging	Applicable cable
UG-23D/U(40)	301-0008-3 40	1	RG-8/U, RG-9/U

■ Panel mount jack

● Flexible cable type

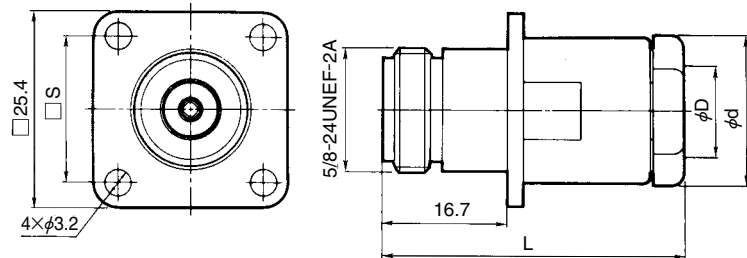

Unit : mm

Part No.	HRS No.	Packaging	Applicable cable	φD	φd	L	□S
UG-22D/U(40)	301-0010-5 40	1	RG-8/U, RG-9/U	11.1	19.0	39.7	18.24
N-PJ-58/U(40)	301-0011-8 40		RG-58/U	5.4	14.6	41.5	18.2

■ Receptacle

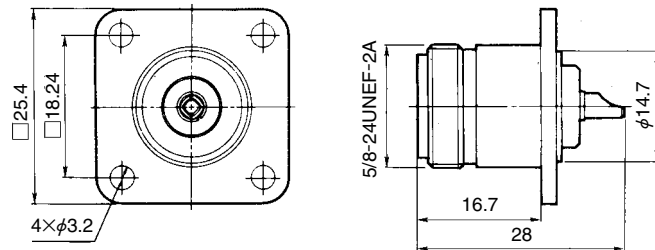

Part No.	HRS No.	Packaging
UG-58A/U(45)	301-0012-0 45	1

■ Straight plug(waterproof type)

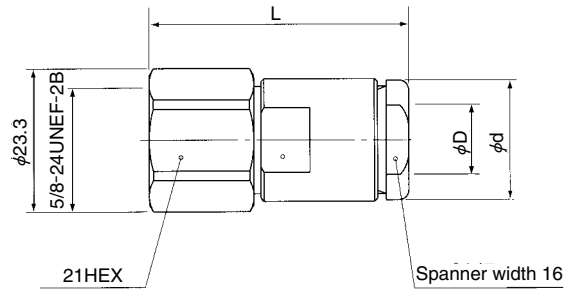

Unit : mm

Part No.	HRS No.	Packaging	Applicable cable	φD	φd	L
N-P-5DFXL(41)	301-0235-5 41	1	5D-FXL	8.6	18	47.2
N-P-8DGXC(40)	301-0228-0 40		8D-GXC	11.6	19.5	49.9

* IP67 compliant

■ Straight jack(waterproof type)

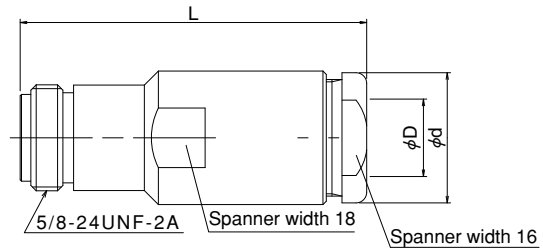

Unit : mm

Part No.	HRS No.	Packaging	Applicable cable	φD	φd	L
N-J-5DFXL(40)	301-0237-0 40	1	5D-FXL	8.6	18	49.1
N-J-8DGXC(40)	301-0229-2 40		8D-GXC	11.6	19.5	51.9

* IP67 compliant

Adapter

● Straight adapter (jack-jack type)

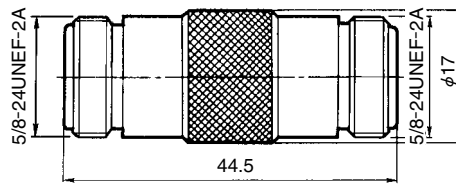

Part No.	HRS No.	Packaging
UG-29B/U(45)	301-0035-6 45	1

(Plug-plug type)

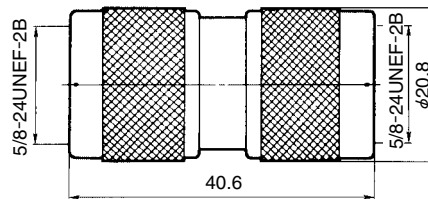

Part No.	HRS No.	Packaging
UG-57B/U(40)	301-0018-7 40	1

● Panel mount adapter (jack-jack type)

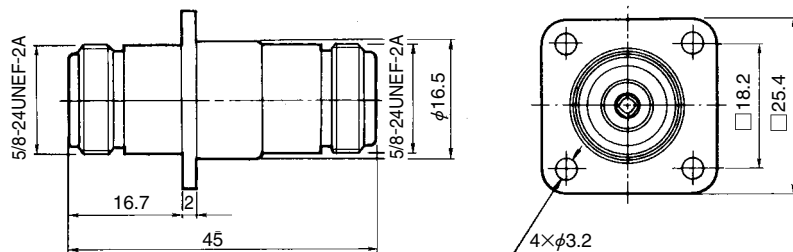

Part No.	HRS No.	Packaging
N-PA(42)	301-0036-9 42	1

● Right angle adapter (Plug-jack type)

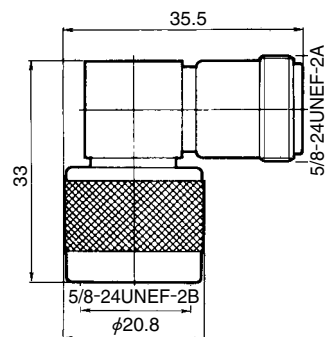

Part No.	HRS No.	Packaging
UG-27C/U(43)	301-0015-9 43	1

● T-shaped adapter
(Jack-jack-jack type)

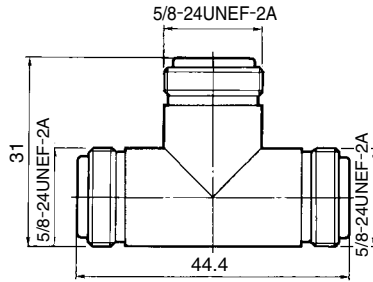

Part No.	HRS No.	Packaging
UG-28A/U(40)	301-0017-4 40	1

(Jack-plug-jack)

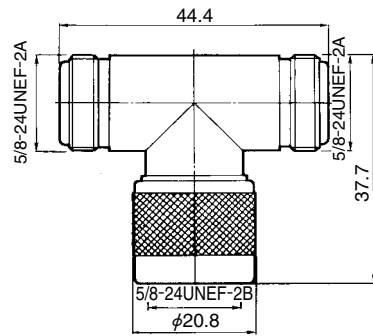

Part No.	HRS No.	Packaging
UG-107B/U(40)	301-0016-1 40	1

■ Conversion adapters

Mating portion 1		Mating portion 2		Part No.	HRS No.	Packaging
Series name	Mating portion	Series name	Mating portion			
N	Plug	BNC	Plug	NP-BNCP(40)	311-0050-7 40	1
			Jack	JUG-201A/U(40)	311-0007-8 40	
		S	Jack	N.P-S.J(40)	311-0245-6 40	
			SMA (HRM)	Plug	HRM-555S(40)	
		Jack		HRM-554S(40)	311-0123-9 40	
		Jack	BNC	Plug	UG-349/U(40)	
	Jack			NJ-BNCJ(40)	311-0005-2 40	
				NJ-BNCJ-PA(40)	311-0014-3 40	
	TNC		Plug	N.J-TNC.P(40)	311-0225-9 40	
	SMA (HRM)		Plug	HRM-553S	311-0121-3	
				HRM-557SV	311-0272-9	
		Jack	HRM-552S	311-0119-1		
	HRM-556SV	311-0298-2				

■ Cap

With a chain

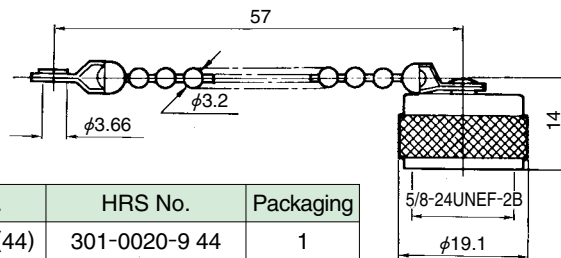

Part No.	HRS No.	Packaging
MX-913/U(44)	301-0020-9 44	1

◆ Cable assembly procedure

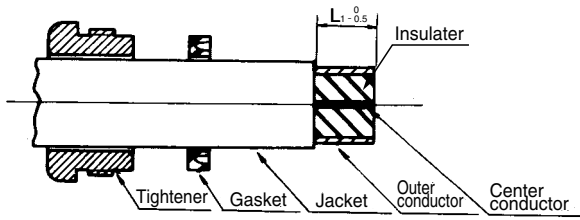

The cable ends are processed as shown in the drawing. For the dimensions L_1 , refer to Table 1, which shows dimensions arranged L by part number.

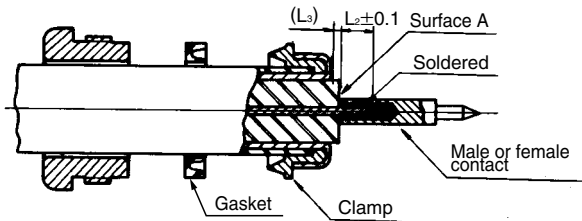

- (1) Insert clamp from tip of cable and fold outer conductor of cable back onto clamp. Using a knife, cut off excess outer conductor left at this time.
- (2) Cut off center conductor of cable at L_2 , from surface A of cable insulation. For dimensions of L_2 and L_3 , refer to Table 1. L_3 is a reference dimension.
- (3) Solder cable center conductor and male contact (or female contact). It is a good idea at this time to solder the contact preliminarily in advance.
(Note: There must be no gap between the contact and the cable insulation.)

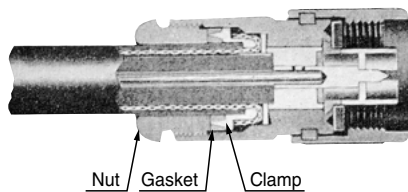

Insert cable and parts into shell and fit sharp end of clamp completely into V-shaped surface of gasket. Tighten tightening nut sufficiently.

■ Remarks

1. The cable dimensions L are based on the MIL and DSP standards. They may differ somewhat depending on the type of cable. In such cases, match the dimensions with the connectors.
2. Some clamps and gaskets does not have not V-shaped, but the assembling procedures are the same.

Table 1 Dimensions L arranged by part number

Unit : mm

Part No.	HRS No.	$L_{1-0.5}$	$L_{2+0.1}$	L_3
JUG-536/U(40)	301-0001-4 40	8.6	6	1
UG-21D/U(47)	301-0003-0 47	10		
N-LP-5DW(40)	301-0007-0 40	11.5	4	3.5
UG-23D/U(40)	301-0008-3 40	8.5	5	1
UG-22D/U(40)	301-0010-5 40			
N-PJ-58/U(40)	301-0011-8 40	7.4	3	3.2
N-LP-58U(40)	301-0076-3 40	9.2	4	3.6
N-P-3DV(41)	301-0078-9 41	12.3	6	4.8
N-P-5DV(40)	301-0120-3 40	11.1		1.5
N-P-5DW(32)	301-0199-3 32	12.0		
N-P-5DFB(40)	301-0205-4 40	11		5
N-P-10DFB(31)	301-0206-7 31			

■ Non-reflective Terminators (Coupling portion plug)

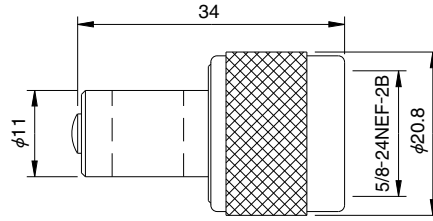

Part No.	HRS No.	Frequency range (GHz)	V.S.W.R.(Max)			Power (W)	Weight (g)	Packaging
			DC~4GHz	4~6GHz	6~8GHz			
N-TMP-1-1(50)	353-0137-5 50	DC~8	1.10	1.15	1.20	1	59	1

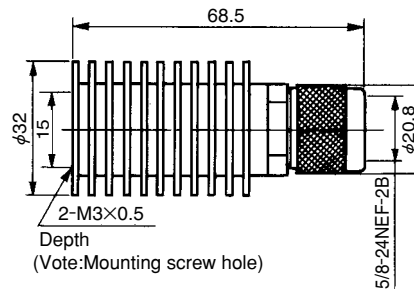

Part No.	HRS No.	Frequency range (GHz)	V.S.W.R.(Max)		Power (W)	Weight (g)	Packaging
			DC~2GHz	2~6GHz			
N-TMP-5(40)	353-0033-0 40	DC~6	1.15	1.20	5	113	1

Fixed Attenuators(plug-jack)

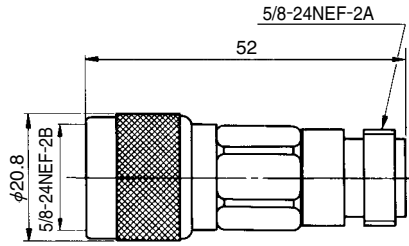

Part No.	HRS No.	Frequency range (GHz)	V.S.W.R.(Max)			Attenuation(dB)			Power (W)	Weight (g)	Packaging
			DC~2GHz	2~4GHz	4~13GHz	DC~2GHz	2~4GHz	4~13GHz			
AT-401(40)	354-0081-9 40	DC~13	1.15	1.20	1.25	1±0.3	1 ^{+0.5} _{-0.3}	1 ^{+0.6} _{-0.3}	2	77	1
AT-402(40)	354-0082-1 40					2±0.3	2 ^{+0.5} _{-0.3}	2 ^{+0.6} _{-0.3}			
AT-403(40)	354-0033-6 40					3±0.3	3 ^{+0.5} _{-0.3}	3 ^{+0.7} _{-0.3}			
AT-406(40)	354-0034-9 40					6±0.3	6 ^{+0.5} _{-0.3}	6 ^{+0.7} _{-0.3}			
AT-410(40)	354-0035-1 40					10±0.5	10 ^{+0.8} _{-0.5}	10 ^{+1.0} _{-0.5}			
AT-420(40)	354-0036-4 40					20±0.5	20 ^{+0.8} _{-0.5}	20 ^{+1.2} _{-0.7}			

Typical data

Non-reflective Terminations

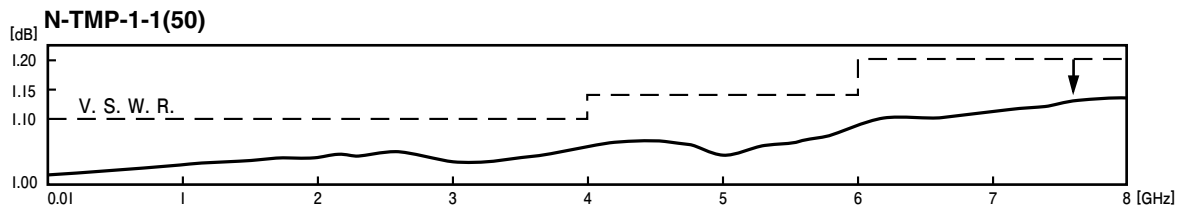

Fixed Attenuator

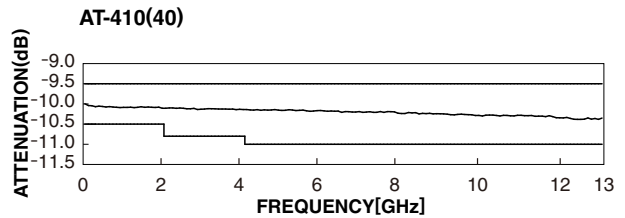
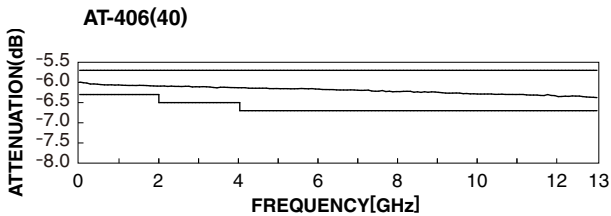
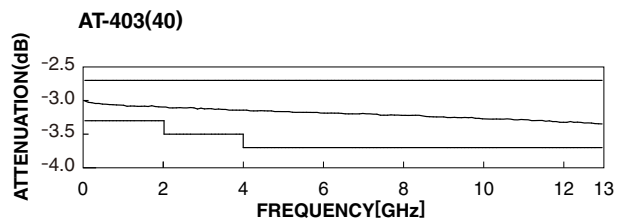
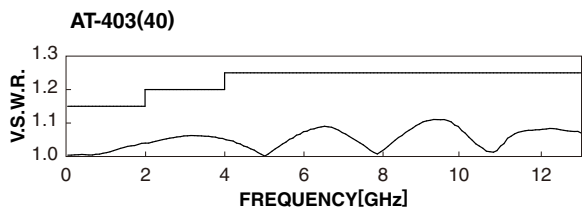

MEMO :

A series of horizontal dashed lines for taking notes.

USA:

HIROSE ELECTRIC (U.S.A.), INC. HEADQUARTERS CHICAGO OFFICE
2300 Warrenville Road, Suite 150,
Downers Grove, IL 60515
Phone : +1-630-282-6700
<http://www.hirose.com/us/>

USA:

HIROSE ELECTRIC (U.S.A.), INC. SAN JOSE OFFICE
2841 Junction Ave, Suite 200
San Jose, CA. 95134
Phone : +1-408-253-9640
Fax : +1-408-253-9641
<http://www.hirose.com/us/>

USA:

HIROSE ELECTRIC (U.S.A.), INC. DETROIT OFFICE (AUTOMOTIVE)
17197 N. Laurel Park Drive, Suite 253,
Livonia, MI 48152
Phone : +1-734-542-9963
Fax : +1-734-542-9964
<http://www.hirose.com/us/>

USA:

HIROSE ELECTRIC (U.S.A.), INC. BOSTON OFFICE
300 Brickstone Square Suite 201,
Andover, MA 01810
Phone : +1-978-662-5255

THE NETHERLANDS:

HIROSE ELECTRIC EUROPE B.V.
Hogehillweg #8 1101 CC Amsterdam Z-0
Phone : +31-20-6557460
Fax : +31-20-6557469
<http://www.hirose.com/eu/>

GERMANY:

HIROSE ELECTRIC EUROPE B.V. GERMAN BRANCH
Schoenbergstr. 20, 73760 ostfildern
Phone : +49-711-456002-1
Fax : +49-711-456002-299
<http://www.hirose.com/eu/>

GERMANY:

HIROSE ELECTRIC EUROPE B.V. NUREMBERG OFFICE
Neumeyerstrasse 22-26, 90411 Nurnberg
Phone : +49-911 32 68 89 63
Fax : +49-911 32 68 89 69
<http://www.hirose.com/eu/>

GERMANY:

HIROSE ELECTRIC EUROPE B.V. HANOVER OFFICE
Bayernstr. 3, Haus C 30855 Langenhagen, Germany
Phone : +49-511 97 82 61 30
Fax : +49-511 97 82 61 35
<http://www.hirose.com/eu/>

FRANCE:

HIROSE ELECTRIC EUROPE B.V. PARIS OFFICE
130 Avenue Joseph Kessel, Bat E, 78960
Voisins le Bretonneux, France
Phone : +33-1-85764886
Fax : +33-1-85764823
<http://www.hirose.com/eu/>

UNITED KINGDOM:

HIROSE ELECTRIC EUROPE BV (UK BRANCH)
4 Newton Court, Kelvin Drive, Knowlhill,
Milton Keynes, MK5 8NH
Phone : +44-1908 202050
Fax : +44-1908 202058
<http://www.hirose.com/eu/>

CHINA:

HIROSE ELECTRIC (CHINA) CO., LTD. (SHANGHAI, HEADQUARTERS)
18, Enterprise Center Tower 2, 209# Gong He
Road, Jing'an District, Shanghai, CHINA 200070
Phone : +86-21-6391-3355
Fax : +86-21-6391-3335
<http://www.hirose.com/cn/>

CHINA:

HIROSE ELECTRIC (CHINA) CO.,LTD. BEIJING BRANCH
A1001, Ocean International Center, Building 56# East 4th
Ring Middle Road, ChaoYang District, Beijing, 100025
Phone : +86-10-5165-9332
Fax : +86-10-5908-1381
<http://www.hirose.com/cn/>

CHINA:

HIROSE ELECTRIC (CHINA) CO., LTD. SHENZHEN BRANCH
Room 09-13, 19/F, Office Tower Shun Hing Square, Di Wang Commercial Centre,
5002 Shen Nan Dong Road, Shenzhen City, Guangdong Province, 518008
Phone : +86-755-8207-0851
Fax : +86-755-8207-0873
<http://www.hirose.com/cn/>

HONG KONG:

HIROSE ELECTRIC HONGKONG TRADING CO., LTD.
Room 1001, West Wing, Tsim Sha Tsui Centre, 66
Mody Road, Tsim Sha Tsui East, Kowloon, Hong Kong
Phone : +852-2803-5338
Fax : +852-2591-6560
<http://www.hirose.com/hk/>

TAIWAN:

HIROSE ELECTRIC TAIWAN CO., LTD.
103 8F, No.87, Zhengzhou Rd., Taipei
Phone : +886-2-2555-7377
Fax : +886-2-2555-7355
<http://www.hirose.com/tw/>

KOREA:

HIROSE KOREA CO.,LTD.
143, Gongdan 1-daero, Siheung-si,
Gyeonggi-do, 15084, Korea
Phone : +82-31-496-7000
Fax : +82-31-496-7100
<http://www.hirose.co.kr/>

SINGAPORE:

HIROSE ELECTRIC SINGAPORE PTE. LTD.
03, Anson Road, #20-01, Springleaf Tower,
Singapore 079909
Phone : +65-6324-6113
Fax : +65-6324-6123
<http://www.hirose.com/sg/>

INDIA:

HIROSE ELECTRIC SINGAPORE PTE. LTD. DELHI LIAISON OFFICE
Office NO.552, Regus-Green Boulevard, Level5, Tower C,
Sec62, Plot B-9A, Block B, Noida, 201301, Uttar Pradesh, India
Phone : +91-12-660-8018
Fax : +91-120-4804949
<http://www.hirose.com/sg/>

INDIA:

HIROSE ELECTRIC SINGAPORE PTE. LTD. BANGALORE LIAISON OFFICE
Unit No-403, 4th Floor, No-84, Barton Centre, Mahatma
Gandhi (MG) Road, Bangalore 560 001, Karnataka, India
Phone : +91-80-4120 1907
Fax : +91-80-4120 9908
<http://www.hirose.com/sg/>

MALAYSIA:

PENANG REPRESENTATIVE OFFICE
73-3-1, Ideal@The One, Jalan Mahsuri, Bayan
Lepas Penang, 11950, Malaysia
Phone : +604-648-5536
<http://www.hirose.com/sg/>

THAILAND:

BANGKOK OFFICE (REPRESENTATIVE OFFICE)
Unit 4703, 47th FL., 1 Empire Tower, South Sathorn
Road, Yannawa, Sathorn, Bangkok 10120 Thailand
Phone : +66-2-686-1255
Fax : +66-2-686-3433
<http://www.hirose.com/sg/>



HIROSE ELECTRIC CO.,LTD.

2-6-3,Nakagawa Chuoh,Tsuzuki-Ku,Yokohama-Shi 224-8540,JAPAN
TEL: +81-45-620-3526 Fax: +81-45-591-3726
<http://www.hirose.com>
<http://www.hirose-connectors.com>

Mouser Electronics

Authorized Distributor

Click to View Pricing, Inventory, Delivery & Lifecycle Information:

[Hirose Electric:](#)

[N-P-10DFB\(31\)](#) [N-P-5DW\(32\)](#)