

**Harvatek Surface Mount CHIP LED Data Sheet
HT-B3053FCH**

Official Product	HT Part No. HT-B3053FCH	Customer Part No.		Data Sheet No.
Preliminary Product	*****	*****		HT-B3053FCH
Specifications are subject to change without notice. Data and drawings herein are copyrighted.		June 22, 2013	Version of 1.0	Page 1/16

DISCLAIMER..... 3

PRODUCT SPECIFICATIONS 4

ATTENTION: ELECTROSTATIC DISCHARGE (ESD) PROTECTION 5

LABEL SPECIFICATIONS 5

ELECTRO-OPTICAL CHARACTERISTICS..... 8

PACKAGE OUTLINE DIMENSION & RECOMMENDED SOLDERING PATTERN FOR SOLDERING 8

ABSOLUTE MAXIMUM RATINGS 8

PRECAUTION FOR USE..... 9

CHARACTERISTICS OF HT-B3053FCH SERIES..... 10

PACKAGING 11

TAPE DIMENSION 11

REEL DIMENSION 12

PACKING 12

DRY PACK..... 13

PRECAUTIONS..... 13

REFLOW SOLDERING 14

REWORKING 14

CLEANING 15

REVISION HISTORY..... 16

Official Product	HT Part No. HT-B3053FCH	Customer Part No.		Data Sheet No.
Preliminary Product	*****	*****		HT-B3053FCH
Specifications are subject to change without notice. Data and drawings herein are copyrighted.		June 22, 2013	Version of 1.0	Page 2/16

DISCLAIMER

HARVATEK reserves the right to make changes without further notice to any products herein to improve reliability, function or design. HARVATEK does not assume any liability arising out of the application or use of any product or circuit described herein; neither does it convey any license under its patent rights, nor the rights of others.

LIFE SUPPORT POLICY

HARVATEK’s products are not authorized for use as critical components in life support devices or systems without the express written approval of the President of HARVATEK or HARVATEK INTERNATIONAL. As used herein:

1. Life support devices or systems are devices or systems which, (a) are intended for surgical implant into the body, or (b) support or sustain life, and (c) whose failure to perform when properly used in accordance with instructions for use provided in the labeling, can be reasonably expected to result in a significant injury of the user.

2. A critical component in any component of a life support device or system whose failure to perform can be reasonably expected to cause the failure of the life support device or system, or to affect its safety or effectiveness.

Official Product	HT Part No. HT-B3053FCH	Customer Part No.		Data Sheet No.
Preliminary Product	*****	*****		HT-B3053FCH
Specifications are subject to change without notice. Data and drawings herein are copyrighted.		June 22, 2013	Version of 1.0	Page 3/16

Product Specifications

	Specification	Material	Quantity
Iv	Red : 110 mcd typical Green : 360 mcd typical Blue : 100 mcd typical R/G/B@20mA/ Ta= 25 °C; Tolerance ±10%		
λD	Red : 622 nm typical Green : 525 nm typical Blue : 467 nm typical R/G/B@20mA/Ta= 25 °C; Tolerance ±0.5nm		
Vf	Red : 2.4 V maximum Green : 3.8 V maximum Blue : 3.8 V maximum R/G/B@20mA/ Ta= 25 °C; Tolerance ± 0.05V		
Ir	< 100 μA @ VR = 5 V		
Resin	Water clear	Epoxy	
Carrier tape	EIA 481-1A specs	Conductive black tape	2000pcs/reel(Minimum)
Reel	EIA 481-1A specs	Conductive black	
Label	HT standard	Paper	
Packing bag	250x230mm	Aluminum laminated bag/ no-zipper	One reel per bag
Carton	HT standard	Paper	Non-specified

Official Product	HT Part No. HT-B3053FCH	Customer Part No.		Data Sheet No.
Preliminary Product	*****	*****		HT-B3053FCH
Specifications are subject to change without notice. Data and drawings herein are copyrighted.		June 22, 2013	Version of 1.0	Page 4/16

Others:

Each immediate box consists of 5 reels. The 5 reels may not necessarily have the same lot number or the same bin combinations of I_v , λ_D and V_f . Each reel has a label identifying its specification; the immediate box consists of a product label as well.

ATTENTION: Electrostatic Discharge (ESD) protection



The symbol to the left denotes that ESD precaution is needed. ESD protection for GaP and AlGaAs based chips is necessary even though they are relatively safe in the presence of low static-electric discharge. Parts built with AlInGaP, GaN, or/and InGaN based chips are **STATIC SENSITIVE devices**. ESD precaution must be taken during design and assembly.

If manual work or processing is needed, please ensure the device is adequately protected from ESD during the process.

Label Specifications

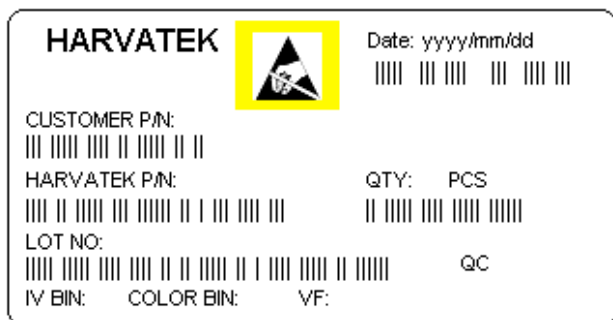

■ Harvatek P/N:

H T - B 3 0 5 3 F C H - Y Y Y Y

Series Name	Package	Dice	Emitting Color	Customer Code
HT= Harvatek	B305= Outline Dimension	3= Triple Dice	FCH= RGB@ 20mA	YYYY Customer Product Code

Official Product	HT Part No. HT-B3053FCH	Customer Part No.		Data Sheet No.
Preliminary Product	*****	*****		HT-B3053FCH
Specifications are subject to change without notice. Data and drawings herein are copyrighted.		June 22, 2013	Version of 1.0	Page 5/16

■ Lot No.:

1	2	3	4	5	6	7	8	9	10
E	1	A	1	A	2	2	L	1	2
Code 1 2		Code 3	Code 4	Code 5	Code 6	Code 7	Code 8	Code 9	Code 10
		Mfg. Year	Mfg. Month	Mfg. Date	Consecutive number		Special code		
Internal Tracing Code		2010-A 2011-B 2012-C 2013-D . .	1:Jan. 2:Feb. A:Oct. B:Nov. C:Dec.	1:A 2:B 3:C ... 26:Z 27:7 28:8 29:9 30:3 31:4	01~ZZ		000~ZZZ		

Official Product	HT Part No. HT-B3053FCH	Customer Part No.		Data Sheet No.
Preliminary Product	*****	*****		HT-B3053FCH
Specifications are subject to change without notice. Data and drawings herein are copyrighted.		June 22, 2013	Version of 1.0	Page 6/16

■ Luminous Intensity (Iv) Bin: R/G/B @20mA

HT-B3053FCH Series								
IV								
R			G			B		
FN1	82.5	99	FS1	250	300	FM3	75.6	91
FN2	91	110	FS2	280	336	FN1	82.5	99
FN3	99	119	FS3	300	360	FN2	91	110
FP1	110	132	FT1	336	405	FN3	99	119
FP2	119	143	FT2	360	435	FP1	110	132
FP3	132	159	FT3	405	490	FP2	119	143
FQ1	143	172						

■ Dominant Wavelength (λ_D) Bin:

HT-B3053FCH Series					
IV					
R		G		B	
R1	616~620	G1	516~520	B1	461~465
R2	618~622	G2	518~522	B2	463~467
R3	620~624	G3	520~524	B3	465~469
R4	622~626	G4	522~526	B4	467~471
R5	624~628	G5	524~528	B5	469~473
R6	626~630	G6	526~530	B6	471~475
R7	628~632	G7	528~532	B7	473~477
R8	630~634	G8	530~534	B8	475~479

■ Forward Voltage (Vf) Bin:

HT-B3053FCH Series					
Vf					
R		G		B	
-	1.6~2.4	-	2.8-3.8	-	2.8-3.8

Official Product	HT Part No. HT-B3053FCH	Customer Part No.		Data Sheet No.
Preliminary Product	*****	*****		HT-B3053FCH
Specifications are subject to change without notice. Data and drawings herein are copyrighted.		June 22, 2013	Version of 1.0	Page 7/16

Electro-Optical Characteristics

(I_F @ 20mA, T_a 25 °C)

Code for parts	Lighting Color	V_F (V)		λ (nm)			I_V (mcd)		I_F (mA)	Viewing Angle 2 θ 1/2
		typ	max	λ_D	λ_P	$\Delta\lambda$	min.	typ.		
HT-B3053FCH	Ultra Bright Red	2.0	2.4	624	630	17	82.5	100	20	120
	Green	3.2	3.8	525	520	40	250	360	20	
	Blue	3.2	3.8	470	468	26	75.6	100	20	

Package Outline Dimension & Recommended Soldering Pattern for Soldering

Unit: mm Tolerance: +/-0.1mm (height maximum is 0.20 +

0.05mm)

Outline Dim.	Soldering Pattern
Soldering terminals may shift in the x, y direction.	

Absolute Maximum Ratings

(T_a 25 °C)

Series	I_F (mA)	I_{FP} (mA)	V_R (V)	I_R (uA)	T_{OP} (°C)	T_{ST} (°C)
Red /Blue/Green	20	100	5	<100@ $V_R = 5$	-30~+85	-40~+85

** Condition for I_{FP} is pulse of 1/10 duty and 0.1msec width

Remarks: This product should be operated in forward bias. If a reverse voltage is continuously applied to the product, such operation can cause migration resulting in LED damage.

Official Product	HT Part No. HT-B3053FCH	Customer Part No.	Data Sheet No.
Preliminary Product	*****	*****	HT-B3053FCH
Specifications are subject to change without notice. Data and drawings herein are copyrighted.		June 22, 2013	Version of 1.0
			Page 8/16

Precaution for Use

1. The chips should not be used directly in any type of fluid such as water, oil, organic solvent, etc.
2. When the LEDs are illuminating, the maximum ambient temperature should be first considered before operation.
3. LEDs must be stored in a clean environment. A sealed container with a nitrogen atmosphere is necessary if the storage period is over 3 months after shipping.
4. The LEDs must be used within seven days after unpacked. Unused products must be repacked in an anti-electrostatic package, folded to close any opening and then stored in a dry and cool space.
5. The appearance and specifications of the products may be modified for improvement without further notice.
6. The LEDs are sensitive to the static electricity and surge. It is strongly recommended to use a grounded wrist band and anti-electrostatic glove when handling the LEDs.

If a voltage over the absolute maximum rating is applied to LEDs, it will damage LEDs. Damaged LEDs will show some abnormal characteristics such as remarkable increase of leak current, lower turn-on voltage and getting unlit at low current.

Official Product	HT Part No. HT-B3053FCH	Customer Part No.		Data Sheet No.
Preliminary Product	*****	*****		HT-B3053FCH
Specifications are subject to change without notice. Data and drawings herein are copyrighted.		June 22, 2013	Version of 1.0	Page 9/16

Characteristics of HT-B3053FCH Series

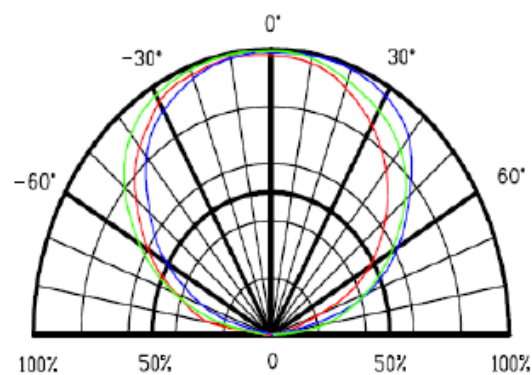
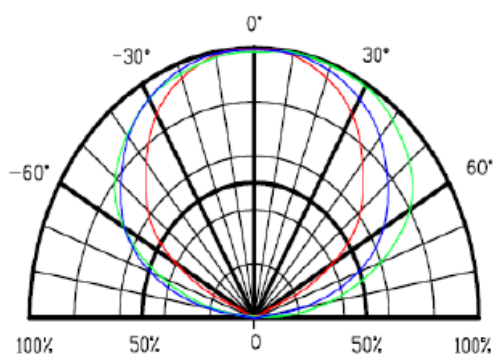
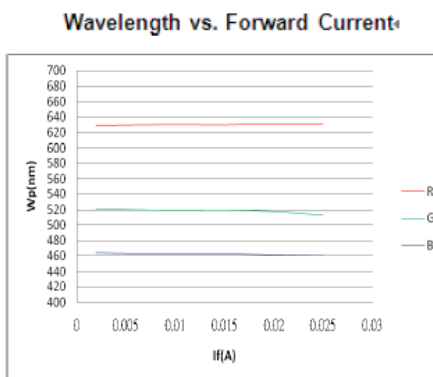
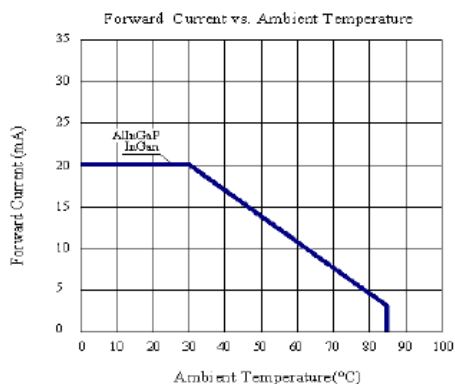
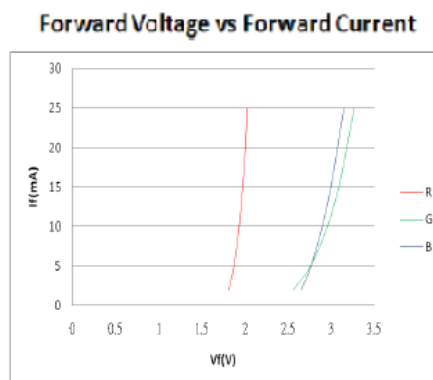
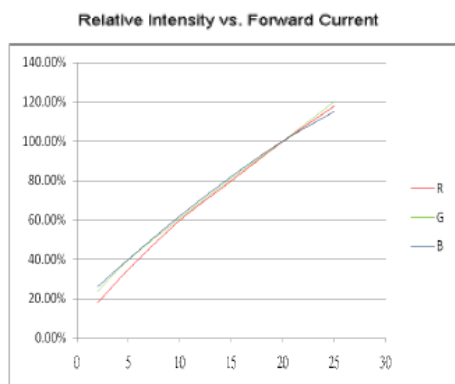

Official Product	HT Part No. HT-B3053FCH	Customer Part No.	Data Sheet No.
Preliminary Product	*****	*****	HT-B3053FCH
Specifications are subject to change without notice. Data and drawings herein are copyrighted.	June 22, 2013	Version of 1.0	Page 10/16

Packaging

Tape Dimension

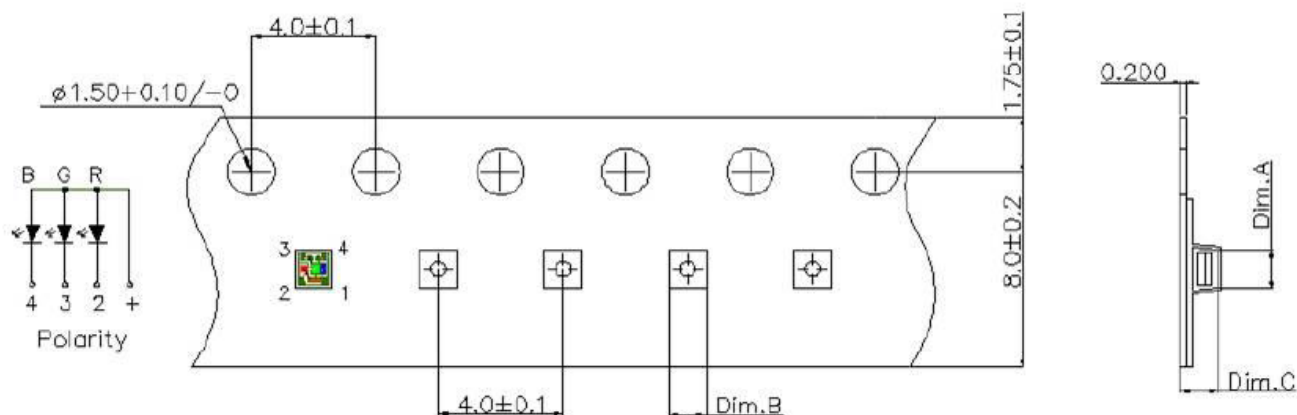

Part No.	Dim. A	Dim. B	Dim. C
HT-B3053FCH	1.13±0.05	1.13±0.05	0.65±0.05

Unit: mm

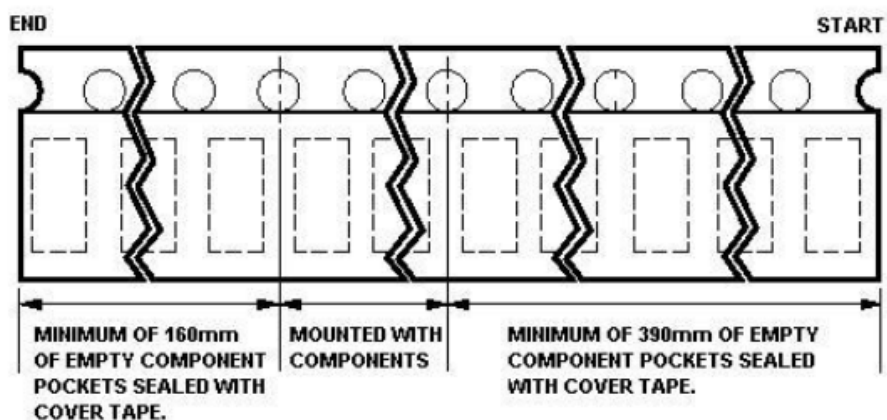

Official Product	HT Part No. HT-B3053FCH	Customer Part No.		Data Sheet No.
Preliminary Product	*****	*****		HT-B3053FCH
Specifications are subject to change without notice. Data and drawings herein are copyrighted.		June 22, 2013	Version of 1.0	Page 11/16

Reel Dimension

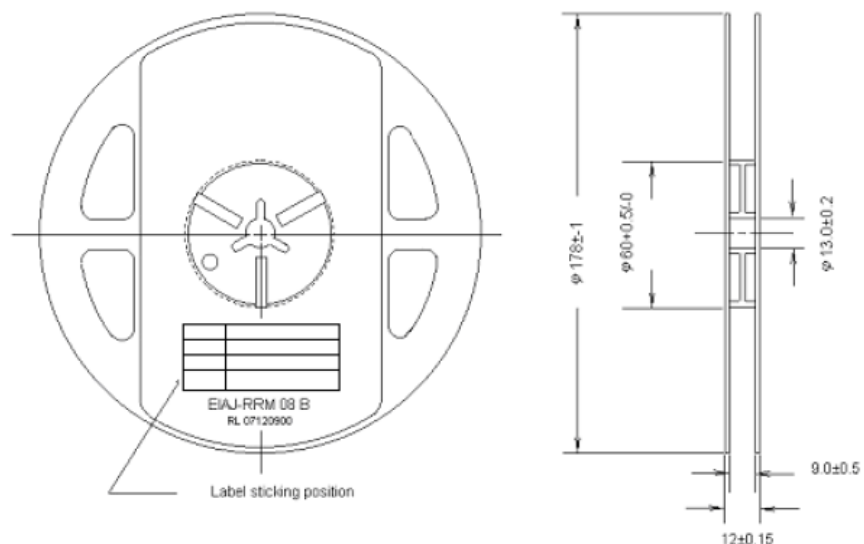

Packing

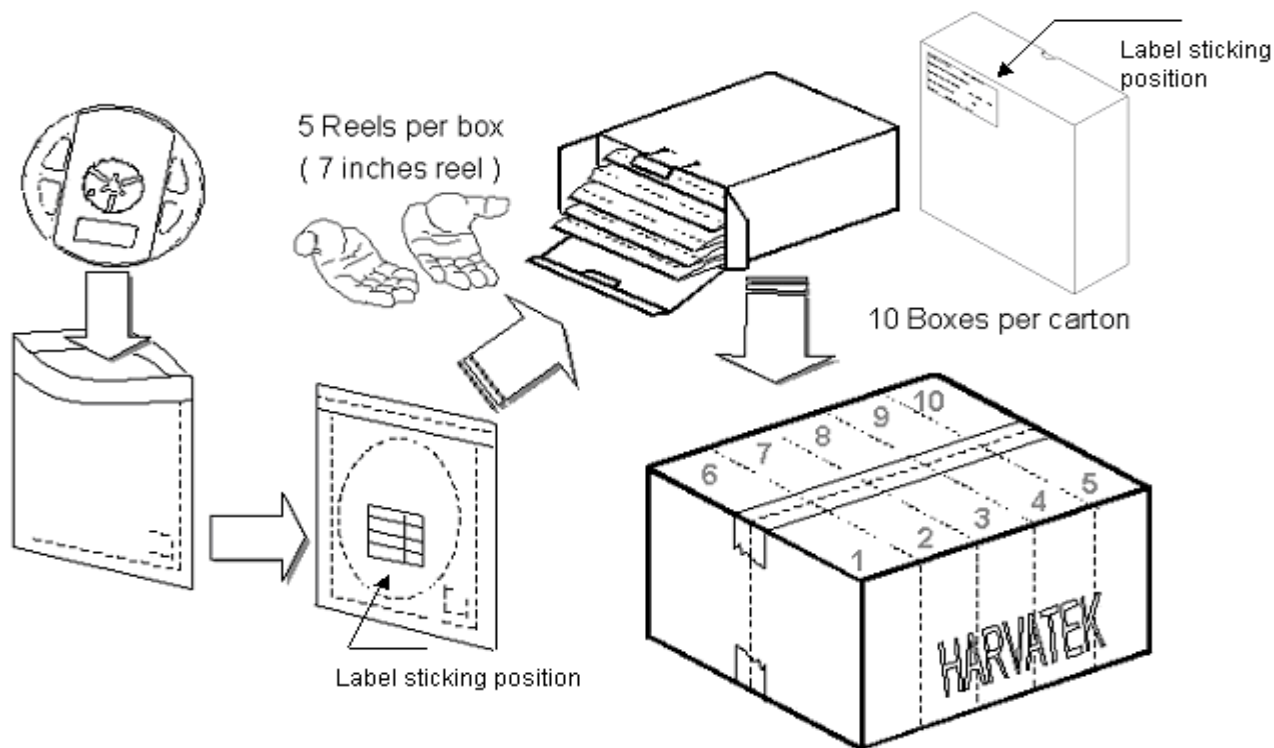

5 boxes per carton is available depending on shipment quantity.

Official Product	HT Part No. HT-B3053FCH	Customer Part No.	Data Sheet No.
Preliminary Product	*****	*****	HT-B3053FCH
Specifications are subject to change without notice. Data and drawings herein are copyrighted.		June 22, 2013	Version of 1.0
			Page 12/16

Dry Pack

All SMD optical devices are **MOISTURE SENSITIVE**. Avoid exposure to moisture at all times during transportation or storage. Every reel is packaged in a moisture protected anti-static bag. Each bag is properly sealed prior to shipment.

Upon request, a humidity indicator will be included in the moisture protected anti-static bag prior to shipment.

The packaging sequence is as follows:

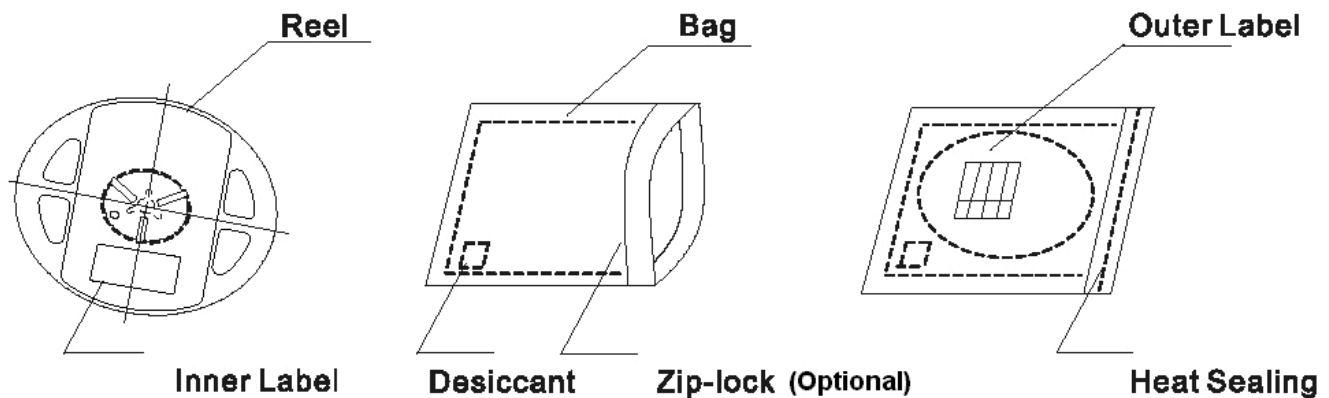

PRECAUTIONS

1. Avoid exposure to moisture at all times during transportation or storage.
2. Anti-Static precaution must be taken when handling GaN, InGaN, and AlInGaP products.
3. It is suggested to connect the unit with a current limiting resistor of the proper size. Avoid applying a reverse voltage beyond the specified limit.
4. Avoid operation beyond the limits as specified by the absolute maximum ratings.
5. Avoid direct contact with the surface through which the LED emits light.
6. If possible, assemble the unit in a clean room or dust-free environment.

Official Product	HT Part No. HT-B3053FCH	Customer Part No.		Data Sheet No.
Preliminary Product	*****	*****		HT-B3053FCH
Specifications are subject to change without notice. Data and drawings herein are copyrighted.		June 22, 2013	Version of 1.0	Page 13/16

Reflow Soldering

Recommend soldering paste specifications:

1. Operating temp.: Above 220°C ,60sec
2. Peak temp.:260°C Max, 10sec Max.
3. Never take next process until the component is cooled down to room temperature after reflow.
4. The recommended reflow soldering profile (measuring on the surface of the LED terminal) is following:

Lead-free Solder Profile

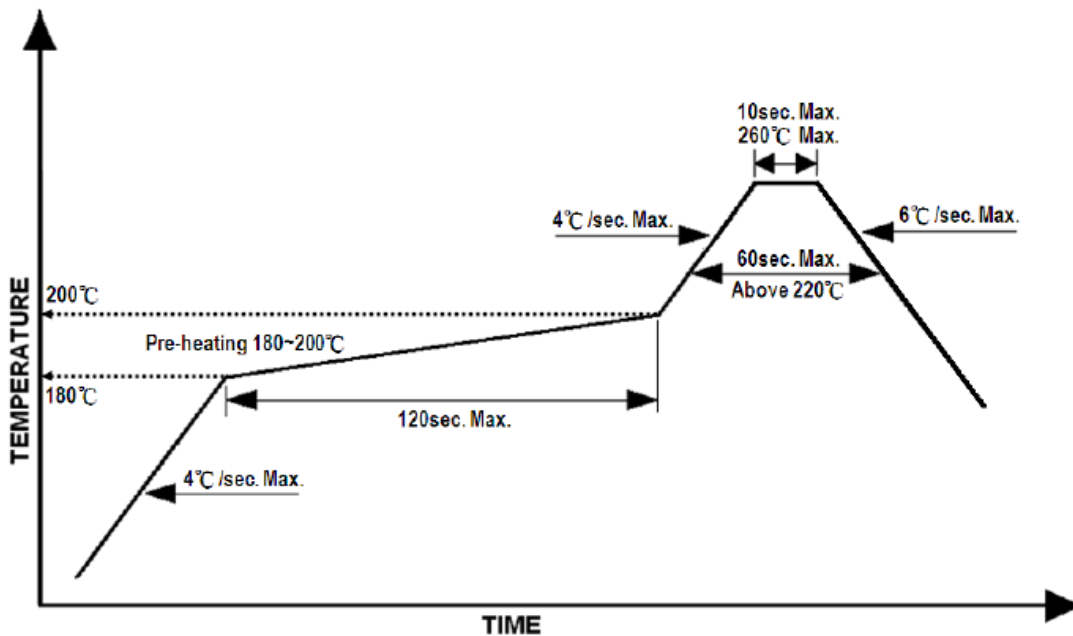

5. Reflow soldering should not be done more than two times

Reworking

- Rework should be completed within 5 seconds under 260°C.
- The iron tip must not come in contact with the copper foil.
- Twin-head type is preferred.

Official Product	HT Part No. HT-B3053FCH	Customer Part No.		Data Sheet No.
Preliminary Product	*****	*****		HT-B3053FCH
Specifications are subject to change without notice. Data and drawings herein are copyrighted.		June 22, 2013	Version of 1.0	Page 14/16

Cleaning

Following are cleaning procedures after soldering:

- An alcohol-based solvent such as isopropyl alcohol (IPA) is recommended.
- Temperature x Time should be 50°C x 30sec. or <30°C x 3min
- Ultra sonic cleaning: < 15W/ bath; bath volume ≤ 1liter
- Curing: 100 °C max, <3min

Cautions of Pick and Place

- Avoid stress on the resin at elevated temperature.
- Avoid rubbing or scraping the resin by any object.
- Electric-static may cause damage to the component. Please ensure that the equipment is properly grounded. Use of an ionizer fan is recommended.

Official Product	HT Part No. HT-B3053FCH	Customer Part No.		Data Sheet No.
Preliminary Product	*****	*****		HT-B3053FCH
Specifications are subject to change without notice. Data and drawings herein are copyrighted.		June 22, 2013	Version of 1.0	Page 15/16

Revision History

Changes since last revision	Page	Version No.	Revision Date
Initial release	-	1.0	06-22-2013

Official Product	HT Part No. HT-B3053FCH	Customer Part No.		Data Sheet No.
Preliminary Product	*****	*****		HT-B3053FCH
Specifications are subject to change without notice. Data and drawings herein are copyrighted.		June 22, 2013	Version of 1.0	Page 16/16

Mouser Electronics

Authorized Distributor

Click to View Pricing, Inventory, Delivery & Lifecycle Information:

[Harvatek:](#)

[HT-B3053FCH](#)