

REVISIONS		
ISS	ZONE	DESCRIPTION\PER REQUEST\DATE

CONFIGURATION CONTROL:
NO CHANGES PERMITTED TO DRAWING WITHOUT
PPAP QUALIFIED CUSTOMER APPROVAL

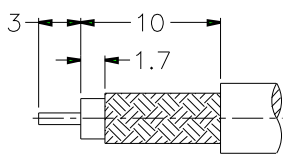

RECOMMENDED
CABLE STRIPPING DIM'S

1. CRIMPED FERRULE
HEX CRIMP SIZE .213"
2. CRIMPED CONTACT PIN
SQ. CRIMP SIZE .042"

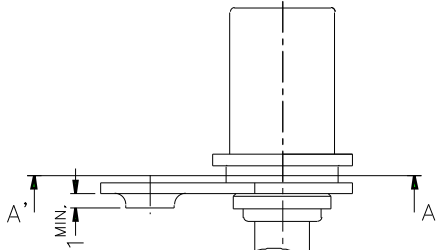
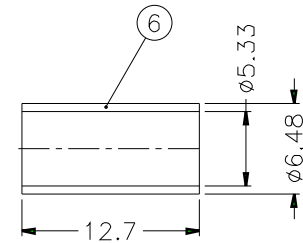
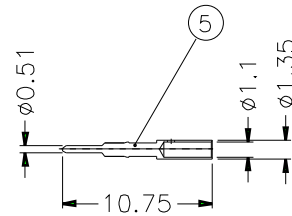
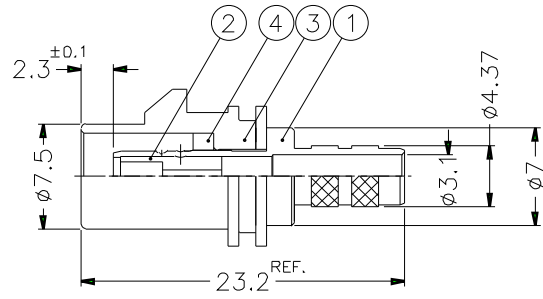
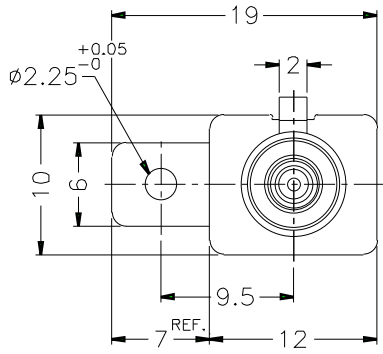

TABLE

KEY CODING	D/N	P/N	LOCK COVER
A	FK1321AW-008-NT30G-50	FA1-NASP-C04-0	FKLC10201A
B	FK1321BW-008-NT30G-50	FA1-NBSP-C04-0	FKLC10202A
C	FK1321CW-008-NT30G-50	FA1-NCSP-C04-0	FKLC10203A
D	FK1321DW-008-NT30G-50	FA1-NDSP-C04-0	FKLC10204A
E	FK1321EW-008-NT30G-50	FA1-NESP-C04-0	FKLC10205A
F	FK1321FW-008-NT30G-50	FA1-NFSP-C04-0	FKLC10206A
G	FK1321GW-008-NT30G-50	FA1-NGSP-C04-0	FKLC10207A
H	FK1321HW-008-NT30G-50	FA1-NHSP-C04-0	FKLC10208A
I	FK1321IW-008-NT30G-50	FA1-NISP-C04-0	FKLC10209A
K	FK1321KW-008-NT30G-50	FA1-NKSP-C04-0	FKLC10210A
Z	FK1321ZW-008-NT30G-50	FA1-NZSP-C04-0	FKLC10211A

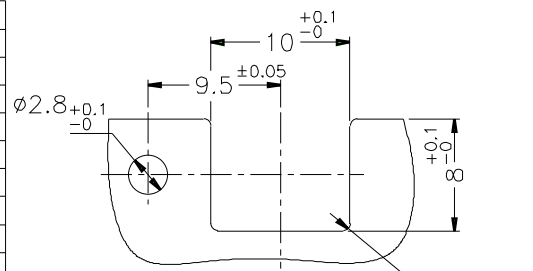

RECOMMENDED
MOUNTING HOLE

- NOTES: FINISH (PLATING THICKNESS IN MICRO-INCHES)
1. BRASS PER QQ-B-626, ALLOY 360, 1/2 H ; JIS H3250 C 3604BD OR EQUIVALENT
 2. NICKEL PL. 60 MIN. THICK OVER COPPER STRIKE
 3. GOLD PL. 30 MIN. THICK OVER NICKEL PL. 100 MIN. THICK OVER COPPER STRIKE
 4. TEFLON MIL-P-19468 OR EQUIVALENT
 5. COPPER PER ASTM B-75 ALLOY C12200 OR EQUIVALENT
 6. PBT(WITH 15% GLASS FIBER) PER CHANG CHUN GRADE 4115202 OR EQUIVALENT

NO.	DESCRIPTION	MATERIAL	FINISH	Q'TY	DRAWING NO.
6	FERRULE	NOTE 5	NOTE 2	1	FKFR00201A
5	CONTACT PIN	NOTE 1	NOTE 3	1	FKCP00301A
4	RING	NOTE 1	NOTE 2	1	FKLR00101A
3	LOCK COVER	NOTE 6		1	SEE TABLE
2	INSULATOR	NOTE 4	NATURAL	1	FKNS00401A
1	MAIN BODY	NOTE 1	NOTE 2	1	FKMB00201A

DIMENSIONS ARE IN MILLIMETERS			
SCALE	2/1	ISSUE	1
UNLESS OTHERWISE SPECIFIED TOLERANCES			
0.5-6 = ±0.2			
6-30 = ±0.4			
30-120 = ±0.6			
120-315 = ±1			
315-1000 = ±1.6			
1000-2000 = ±2.4			

PART NO.	
FA1-NXSP-C04-0	
APPROVED	DATE
	09-25-01'
CHECKED	DATE
	09-25-01'
DRAWN	DATE
ANGELA	09-25-01'

Amphenol
Danbury,CT,USA-Tainan,Taiwan-Shenzehn,China

TITLE
FAKRA SMB CRIMP PLUG
(FOR RG-58A/U, 58C/U CABLE)

DRAWING NO.
KJ-FK1321XX-008-NT30G-50

FILE NO. F:\DWG\FK\FA1\NXSP\C04\0

Mouser Electronics

Authorized Distributor

Click to View Pricing, Inventory, Delivery & Lifecycle Information:

[Amphenol:](#)

[FA1-NBSP-C04-0](#) [FA1-NCSP-C04-0](#) [FA1-NFSP-C04-0](#) [FA1-NISP-C04-0](#) [FA1-NZSP-C04-0](#)