



BOARD LEVEL COOLING – Square Skived Fin

Square skived fin is a series of square skived fin board level heat sinks designed to cool BGA and FPGA devices. Representative image only.

ORDERING INFORMATION

Part Number	Device Type
342940	BGA, FPGA
342941	BGA, FPGA
342942	BGA, FPGA
342943	BGA, FPGA
342945	BGA, FPGA
342946	BGA, FPGA
342947	BGA, FPGA
342948	BGA, FPGA
342949	BGA, FPGA
342950	BGA, FPGA

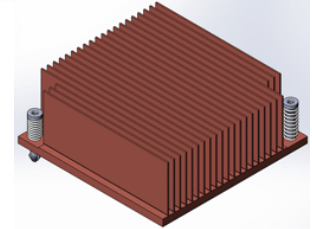
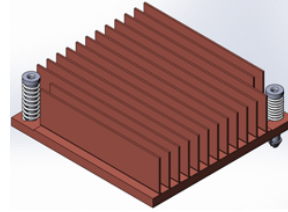

HEAT SINK DETAILS

Property	Details
Material	Copper
Finish	AavSHIELD 3C
Device Attachment Options	Push Pin

Property	Details
Thermal Interface Material	Laird TPCM 585
Heat Sink Mounting Direction	Horizontal

MECHANICAL & PERFORMANCE

Drawing dimensions are shown in mm, (in)

Part Number	"T" Dim	"H" Dim	"W" Dim	"L" Dim
342940	2.80 (0.110)	14.00	38.50	37.58
342941	2.80 (0.110)	13.50	40.00	40.50
342942	2.80 (0.110)	22.50	45.00	44.00
342943	2.80 (0.110)	14.00	50.00	50.00
342945	2.80 (0.110)	14.00	60.00	60.00
342946	2.80 (0.110)	22.00	60.00	60.00
342947	2.80 (0.110)	11.00	57.90	59.00
342948	2.80 (0.110)	14.00	70.00	69.00
342949	2.30 (0.091)	12.00	80.00	80.00
342950	2.30 (0.091)	10.00	90.00	90.00

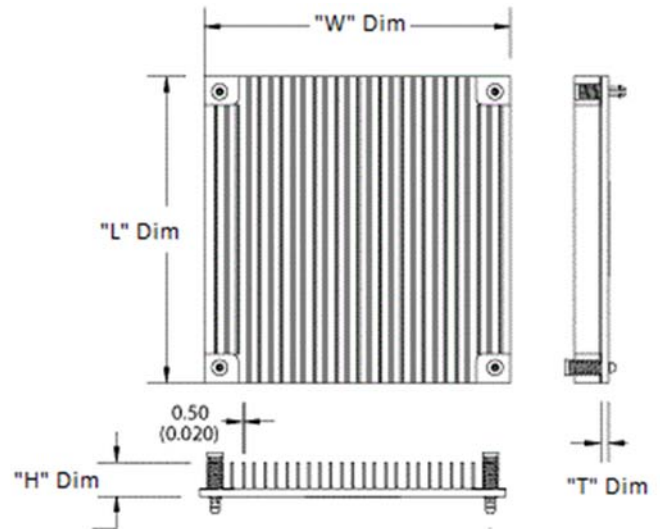

Part Number: 342943

Mounting Details:

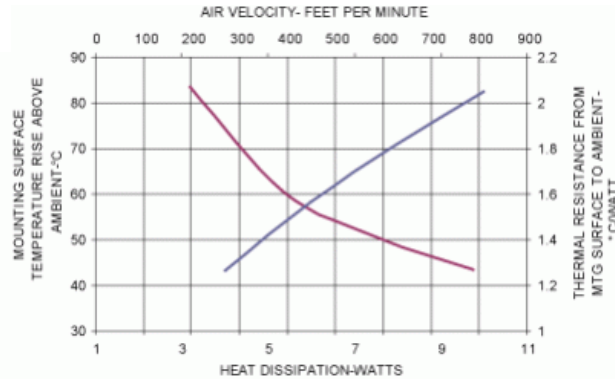
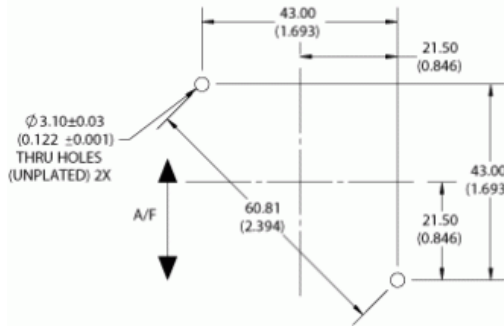

Part Number: 342945

Mounting Details:

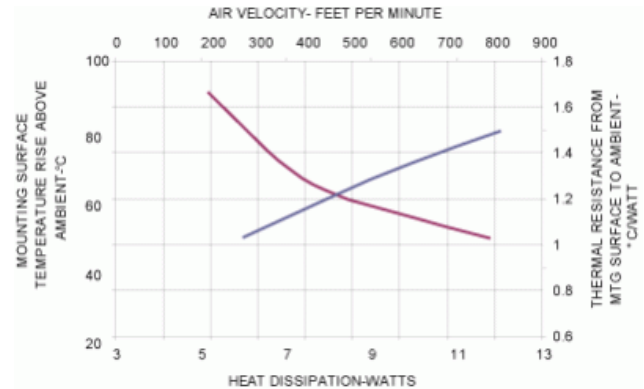
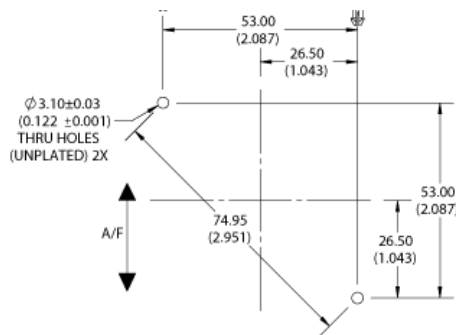

Part Number: 342946

Mounting Details:

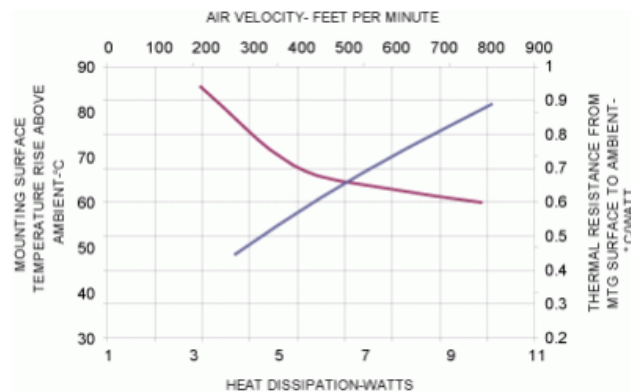
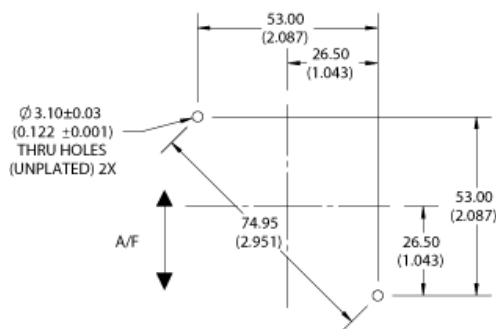

Part Number: 342947

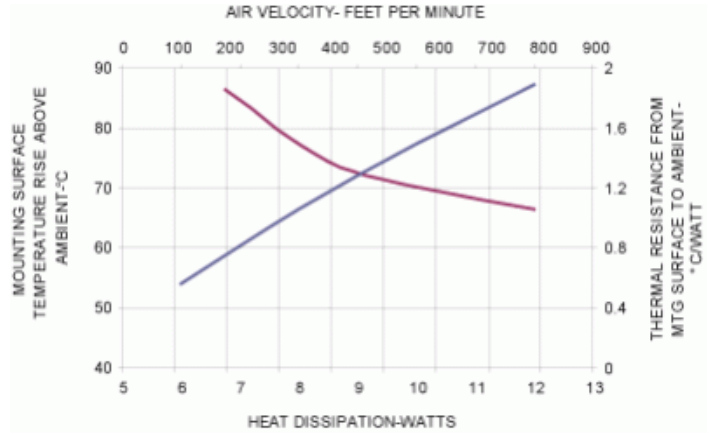
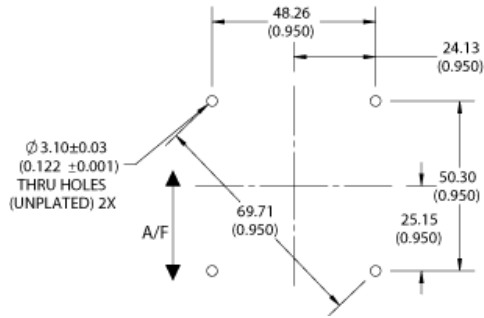

Part Number: 342948

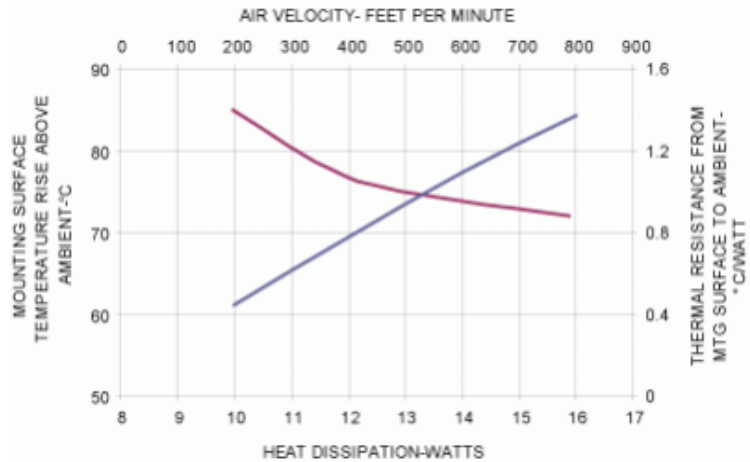
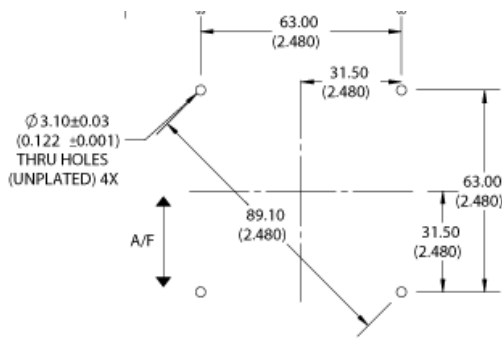

Part Number: 342949

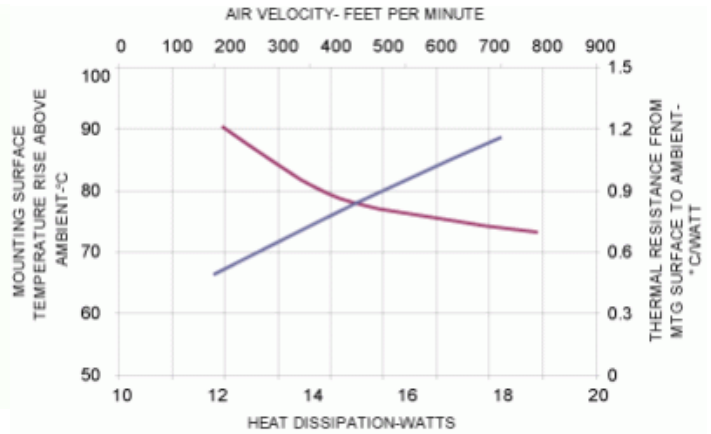
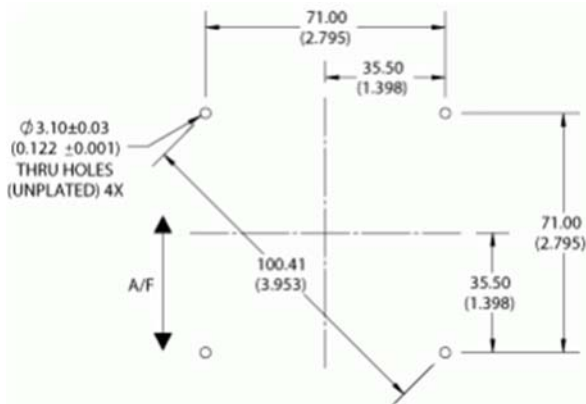

Part Number: 342950

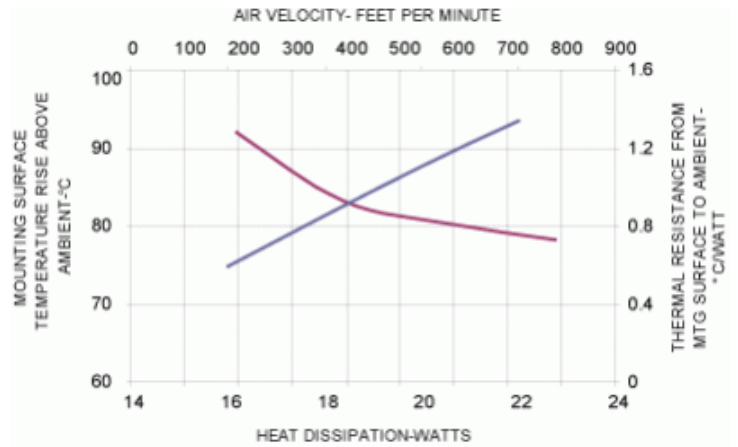
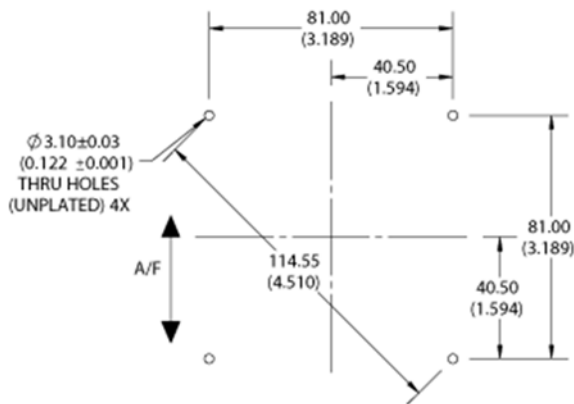

Mouser Electronics

Authorized Distributor

Click to View Pricing, Inventory, Delivery & Lifecycle Information:

[Amphenol:](#)

[342946](#)