

HOUSING BODY WITH 4 CONTACTS

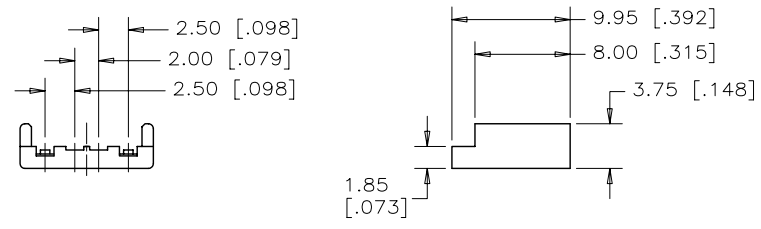
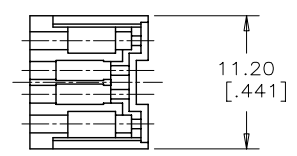

COVER

REVISIONS				
SYM	ZONE	ECN, ERN NO.	DATE	APPRD.
A		RELEASE DWG PER ECN E07122	APR26.07	L.C
B		PROPOSAL	MAR 4.07	L.C

NOTES:

- MATERIALS:
 - CONTACTS: COPPER ALLOY. GOLD PLATING ON MATING AREA ,REFER TO AMPHENOL PART NUMBER OPTION. 50u" NICKEL PLATED UNDERPLATE ALLOVER. 100u" TIN PLATED SOLDER AREA.
 - FRONT & REAR SHELLS: STEEL, 0.35 [.014] THICK. FRONT & REAR SHELL NICKEL PLATED.
 - HOUSING BODY & COVER: PBT, GLASS FILLED, FLAMMABILITY UL94V-0. COLOUR: REFER TO AMPHENOL PART NUMBER OPTION.
- TOLERANCE UNLESS INDICATED OTHERWISE: ±0.30 [.012].



AMPHENOL P/N: UE28-AMX4-XX0

CONTACT PLATING _____
 5=[0.76 MICRONS] 30u" GOLD
 7=[0.08 MICRONS] 3u" GOLD

COLOUR _____
 1=BLACK
 2=BEIGE

SHELL STYLE _____
 2=SMALL REAR CLAMP
 3=LARGE REAR CLAMP (STANDARD)

SEE SHEET 2 FOR SHELL DETAILS

DRAWN	MT.CHEN	DATE	APR26.07
DESIGNED	MT.CHEN	DATE	APR26.07
CHECKED	L.CHAN	DATE	APR26.07
I. E. APPRD.			
Q. A. APPRD.			
DWG. APPRD.			

Amphenol Canada Corp.

TITLE		DWG	DRAWING NO.	REV.
UNIVERSAL SERIAL BUS (SERIES A) PLUG, SOLDER CUP, 4 CONTACTS-ROHS COMPLIANT				
REF.	ECN E07122	C	P-UE28-AMX4-XX0	B

ENG. REL. NO.		DWG	DRAWING NO.	REV.
DIMENSIONS ARE IN	CODE ID. NO.	SCALE	3/1	WT. ----- SURF. ----- SHEET 1 of 2
mm [INCHES]	03554			

THIS DOCUMENT CONTAINS PROPRIETARY INFORMATION AND SUCH INFORMATION MAY NOT BE DISCLOSED TO OTHERS FOR ANY PURPOSE OR USED FOR MANUFACTURING PURPOSES WITHOUT WRITTEN PERMISSION FROM AMPHENOL CANADA CORP.

REVISIONS				
SYM	ZONE	ECN, ERN NO.	DATE	APPRD.
A		RELEASE DWG PER ECN E07122	APR26.07	L.C
B		PROPOSAL	MAR 4.07	L.C

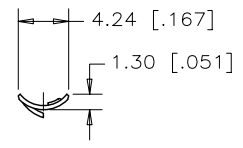
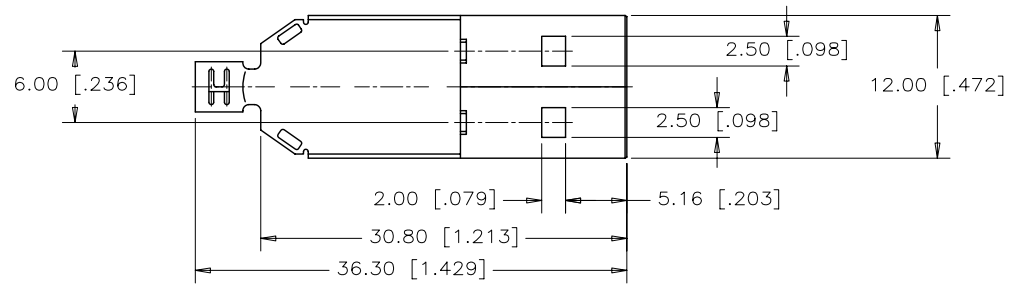

PARTIAL LEFT END VIEW

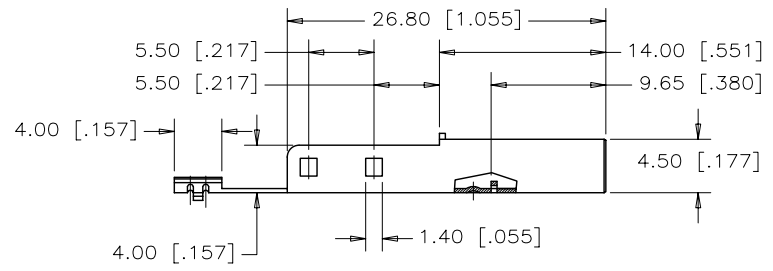

FRONT SHELL

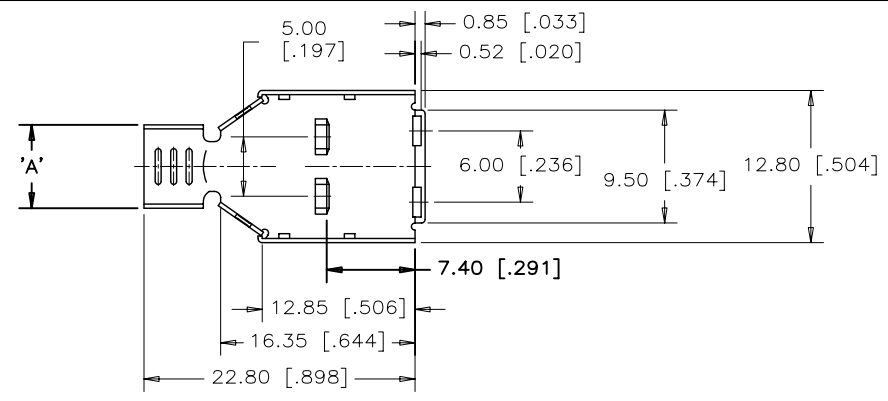
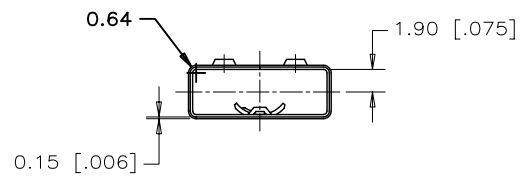

SHELL STYLE	'A'	'B'
SMALL REAR CLAMP ($\phi 3.2 \sim \phi 4.0$)	6.80 [.268]	6.00 [.236]
LARGE REAR CLAMP ($\phi 4.2 \sim \phi 5.0$)	9.00 [.354]	7.00 [.276]



PARTIAL LEFT END VIEW

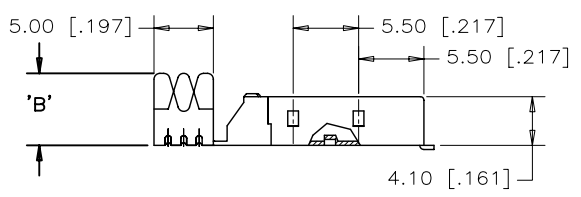

REAR SHELL

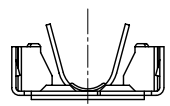

DRAWN	MT.CHEN	DATE	APR26.07	Amphenol Canada Corp.	
DESIGNED	MT.CHEN	DATE	APR26.07		
CHECKED	L.CHAN	DATE	APR26.07	TITLE UNIVERSAL SERIAL BUS (SERIES A) PLUG, SOLDER CUP, 4 CONTACTS-RoHS COMPLIANT	
I. E. APPRD.					
Q. A. APPRD.				DWG DRAWING NO. C P-UE28-AMX4-XXO	
DWG. APPRD.					
ENG. REL. NO.				REF.	ECN E07122
DIMENSIONS ARE IN			CODE ID. NO.	REV. B	
mm [INCHES]			03554	SCALE	3/1
			WT.	SURF.	SHEET 2 OF 2

THIS DOCUMENT CONTAINS PROPRIETARY INFORMATION AND SUCH INFORMATION MAY NOT BE DISCLOSED TO OTHERS FOR ANY PURPOSE OR USED FOR MANUFACTURING PURPOSES WITHOUT WRITTEN PERMISSION FROM AMPHENOL CANADA CORP.

Mouser Electronics

Authorized Distributor

Click to View Pricing, Inventory, Delivery & Lifecycle Information:

[Amphenol:](#)

[UE28AM54130](#)