

REV.	DATE	DESCRIPTION
NC	04/01/08	INITIAL RELEASE

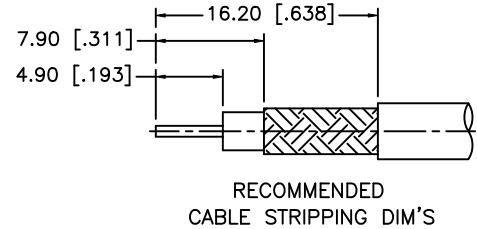
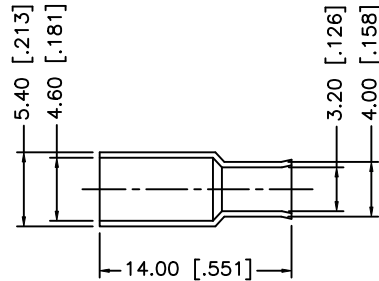
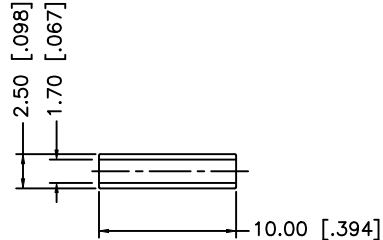
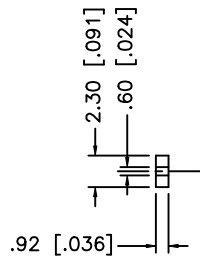
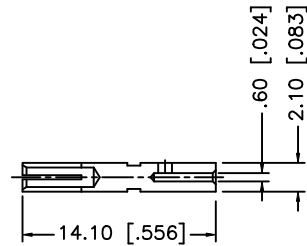
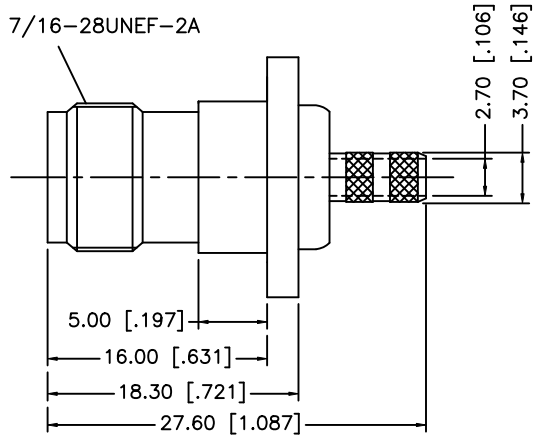
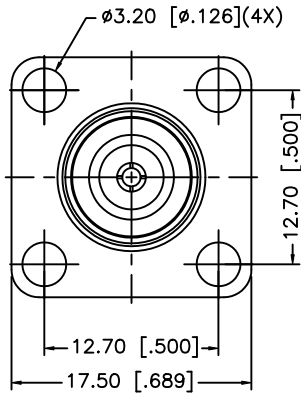

NOTE:

1. CRIMPED FERRULE HEX CRIMP SIZE .178"
2. CRIMPED CONTACT PIN HEX CRIMP SIZE .068"

DESCRIPTION	MATERIAL	FINISH	QTY	
8				
7	FERRULE	BRASS	NICKEL	1
6	SLEEVE	TEFLON	NATURAL	1
5	SPACER	BRASS	NICKEL	1
4	CONTACT PIN	PHOS. BRONZE	GOLD	1
3	BODY	BRASS	NICKEL	1
2	INSULATOR	DELRIN	NATURAL	1
1	HOUSING	BRASS	NICKEL	1

UNLESS OTHERWISE SPECIFIED DIMENSIONS ARE IN MILLIMETERS. DIMENSIONS IN [] ARE IN INCHES AND FOR CUSTOMER REFERENCE ONLY.

UNLESS OTHERWISE SPECIFIED TOLERANCES FOR MILLIMETERS ARE:
0.5 - 8mm ± 0.20mm
8 - 30mm ± 0.40mm
30 - 120mm ± 0.50mm

UNLESS OTHERWISE SPECIFIED TOLERANCES FOR INCHES ARE:
.020 - .315 = ± 0.007"
.315 - 1.180 = ± 0.015"
1.180 - 4.724 = ± 0.020"

DO NOT SCALE DRAWING

APPROVALS	DATE
DRAWN G.R.S.	04/01/08
CHECKED	
ISSUED	
SHEET 1 OF 1	
CAD FILE	C:/122/122379.DWG

Amphenol Connex

PART DESCRIPTION
**TNC PANEL CRIMP JACK
FOR RG-316 DOUBLE BRAID**

PART NO.
122379

DWG. NO.	122379.DWG	REV.	NC	SIZE	A	SCALE	NA
----------	------------	------	----	------	---	-------	----

Mouser Electronics

Authorized Distributor

Click to View Pricing, Inventory, Delivery & Lifecycle Information:

[Amphenol:](#)

[122379](#)