

Automotive / Appliance control

6 mm carbon potentiometer PS-6



Mechanical specifications

| | |
|---------------------------|------------------------------------|
| Mechanical rotation angle | 235° ± 5° |
| Electrical rotation angle | 200° ± 20° |
| Torque | 0.2 to 2 Ncm. (0.3 to 2.7 in - oz) |
| Stop torque | > 4 Ncm. (>7 in-oz) |
| Life* | 1K cycles |

Electrical specifications

| | |
|------------------------------|---|
| Range of values * | 1KΩ ≤ Rn ≤ 1.5MΩ (Decad. 1.0 - 2.0 - 2.2 - 2.5 - 4.7 - 5.0) |
| Tolerance * | 1KΩ ≤ Rn ≤ 500KΩ ----- ±30% 500KΩ < Rn ≤ 1.5MΩ ----- +50% / -30% |
| Nominal power @ 50°C (122°F) | 0.1 W |
| Taper * | Linear |
| Residual resistance | ≤ 5 · 10 ⁻³ Rn |
| Operating temperature | - 40°C to +85°C |

* Others: upon request

Main features

- Specifically designed for leadfree reflow soldering processes (excellent performance).
- Carbon resistive element.
- IP54 protection according to IEC 60529.
- Moisture sensitivity level 1.
- Embossed tape according to IEC 60286-3:2007.
- Wiped positioned at initial, 50% or fully clockwise.
- Full traceability.
- Stop positions.

- Also upon request:
 - Long life model for low cost control potentiometer applications.
 - Shaft - knob.
 - Self extinguishable plastic UL 94V-0

Description

The PS-6 potentiometer offers control where frequent adjustment is required. The shaftless design allows for employment of different engagement mechanisms, such as a customized shaft, a motor control or a human interface adjustment.

This potentiometer can also control variable outputs including frequency, change in motor speed or volume.

Typical applications include popular in hundreds of white goods, motor control, timer relays, power supply, appliance panel control, and automotive sensing applications, now offer product designers the full features of PIHER larger products in a miniature control / trimmer package.

This datasheet shows you the basics of the PS-6 potentiometer that is quite versatile and easy to tailor. Do not hesitate to contact Piher for advice.

6 mm carbon potentiometer PS-6

How to order

Optional extras

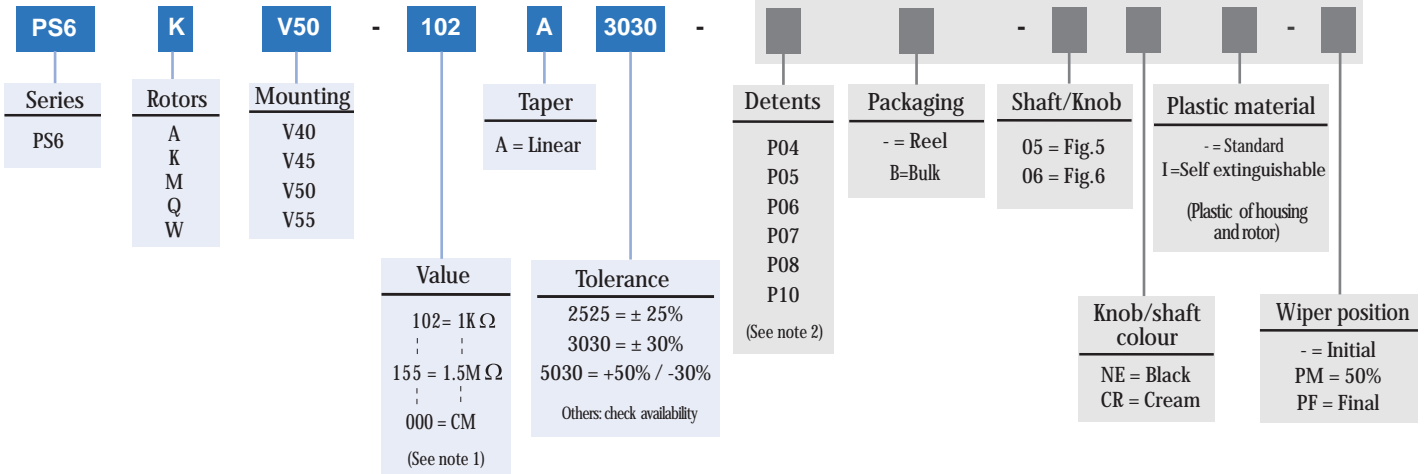

NOTES: (1) Value: – Code: 22 3 = 22KΩ
 → Number of zeros
 → First two digits.
 – 000 = CM = switch SPDT version (contact us for further information)

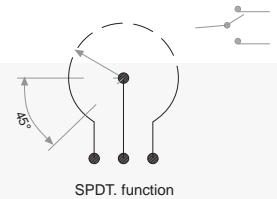

| | | | | | | | | | | | | | | | | | | | | |
|--------------------|------|-----|------|------|------|-----|-----|-----|-----|-----|-----|-----|------|------|------|------|------|------|-------------|------|
| Resistance Ω | 1K | 2K | 2.2K | 2.5K | 4.7K | 5K | 10K | 20K | 22K | 25K | 47K | 50K | 100K | 200K | 220K | 250K | 470K | 500K | 1M | 1.5M |
| How to order code | 102 | 202 | 222 | 252 | 472 | 502 | 103 | 203 | 223 | 253 | 473 | 503 | 104 | 204 | 224 | 254 | 474 | 504 | 105 | 155 |
| Standard tolerance | ±30% | | | | | | | | | | | | | | | | | | +50% / -30% | |

(2) Detented versions are available for K and M rotor types. Rotor color: brown. others: check availability.

How to order examples

PS6KV50-103A3030

PS6 model with K rotor, V50 mounting type, 10K ohm resistive value, linear taper and 30% tolerance.

PS6WV40-502A2525-06NE-PF

PS6 model with inserted knob fig. 6, 5K ohm resistive value, linear taper, 25% tolerance, color of the knob: black; wiper positioned at the end of the travel.

Standard - default options

- Rotor colour ----- Grey
- Housing colour ----- Grey
- Wiper position ----- Initial
- Packaging ----- Reel
- Life ----- 1K cycles
- Detents ----- None
- Plastic material ----- Self extinguishable UL 94V-0 (housing and rotor)

Automotive / Appliance control

6 mm carbon potentiometer PS-6

Rotors (Default delivery is at initial position. Wipers are shown positioned at 50% for the picture)

K= Cross slot through hole

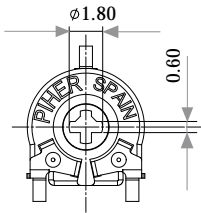

Q= Cross slot through hole
Available in white color only

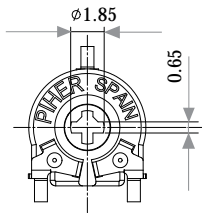

M= Hexagonal through hole

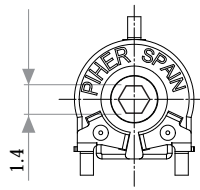

A= Hexagonal through hole
Available in white color only

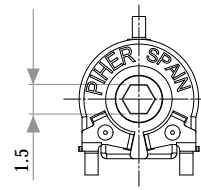

W = with inserted knob. Default color of the knob: cream.
Drawing example, W V40 with knob ref 6:

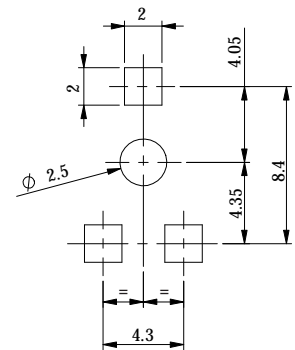
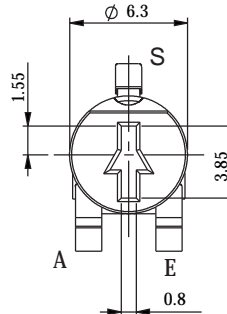
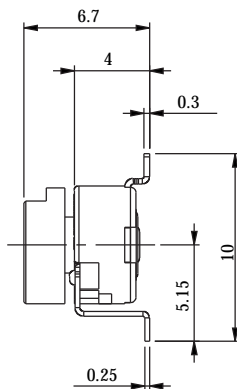
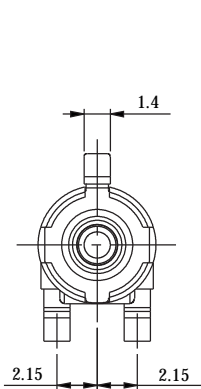
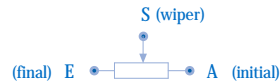

Mounting methods

Dimensions - V40

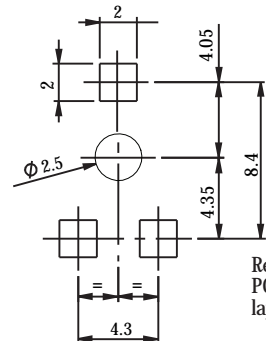
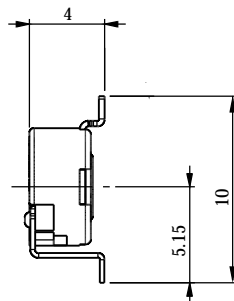
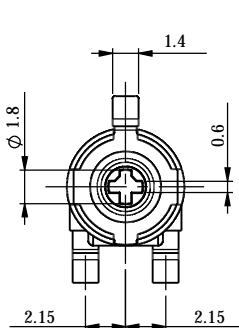

Recommended
PCB hole
layout

Automotive / Appliance control

6 mm carbon potentiometer PS-6

Mounting methods

Dimensions - V45

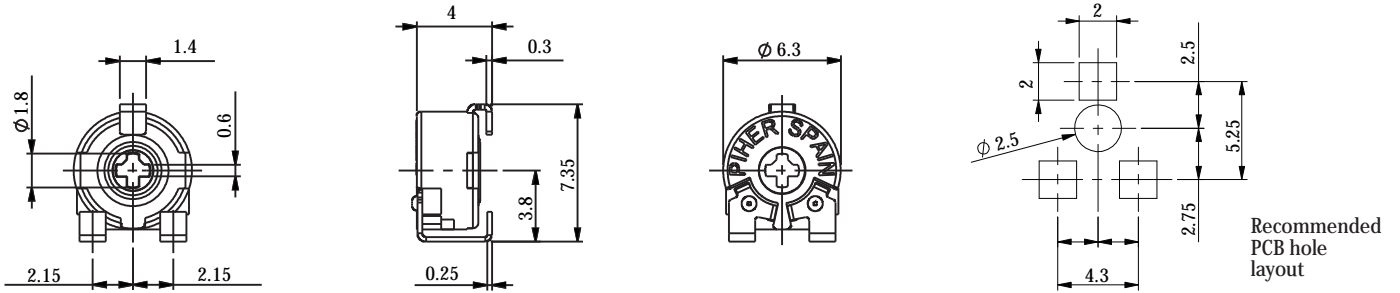

Dimensions - V50

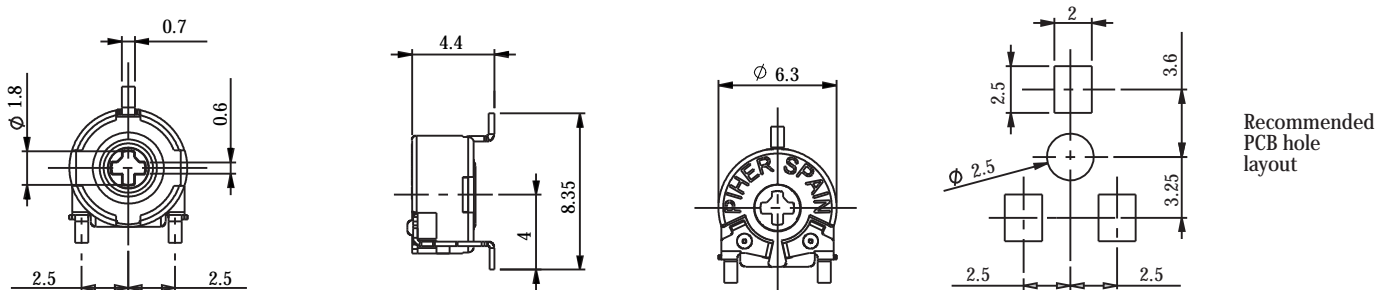

Dimensions - V55

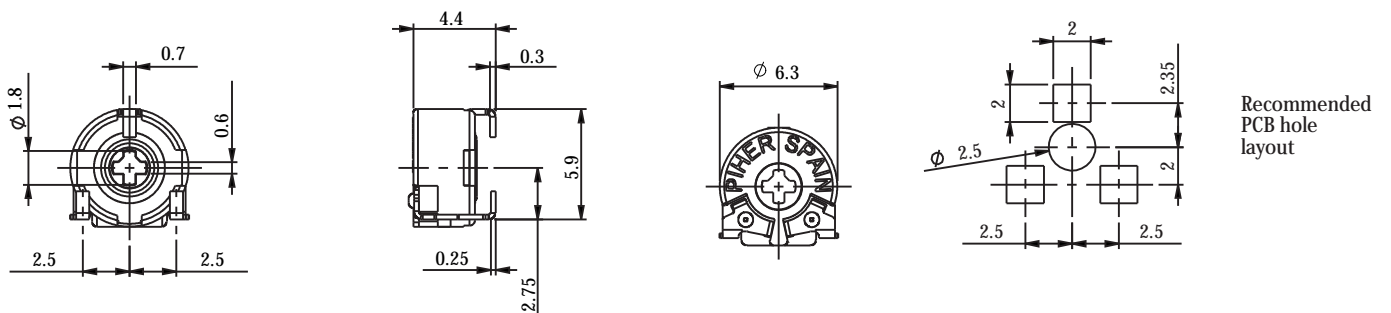

Download STEP files here:
<https://piher.net/piher/?p=897>

Automotive / Appliance control

6 mm carbon potentiometer PS-6

Shaft / Knob

If you wish to use your own plastic shaft/knob/actuator please contact Piher for advice about compatible materials.

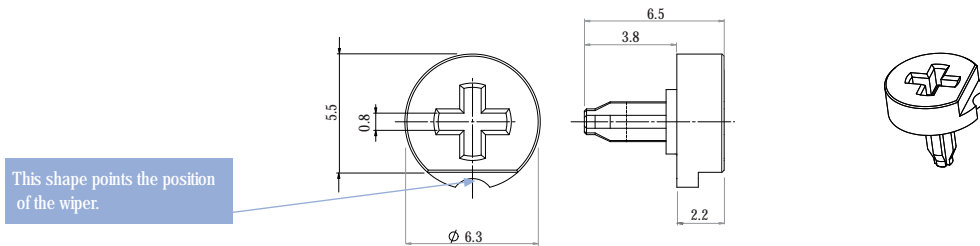

Ref.: 6148 / Fig. 5

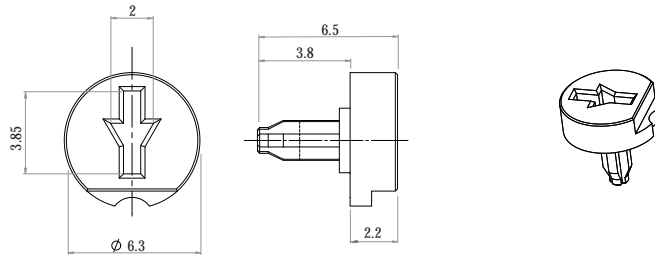

Ref.: 6160 / Fig. 6

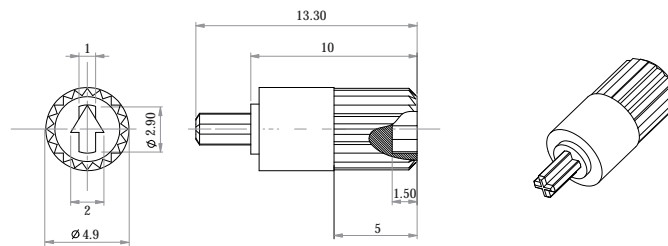

Color: black, others check availability. Please order this shaft separately as it is not provided-factory assembled to the potentiometer

Ref.: 6144

Positioning

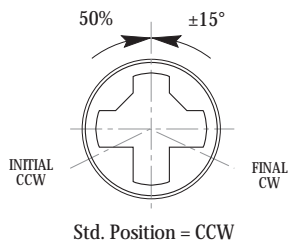

Detents - stop positions

Note: the standard mechanical life for PS6 with detents is 100 cycles.

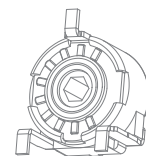
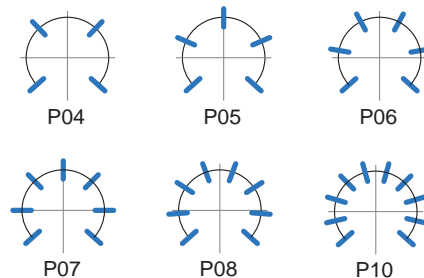

— Relative detent positions along the total mechanical travel.

6 mm carbon potentiometer PS-6

Packaging

V40 and V45 models

BULK (1000pcs / Box)

EMBOSSED TAPE (1000pcs / Reel)

Models with factory-assembled knob will use a reel of 380mm diameter.

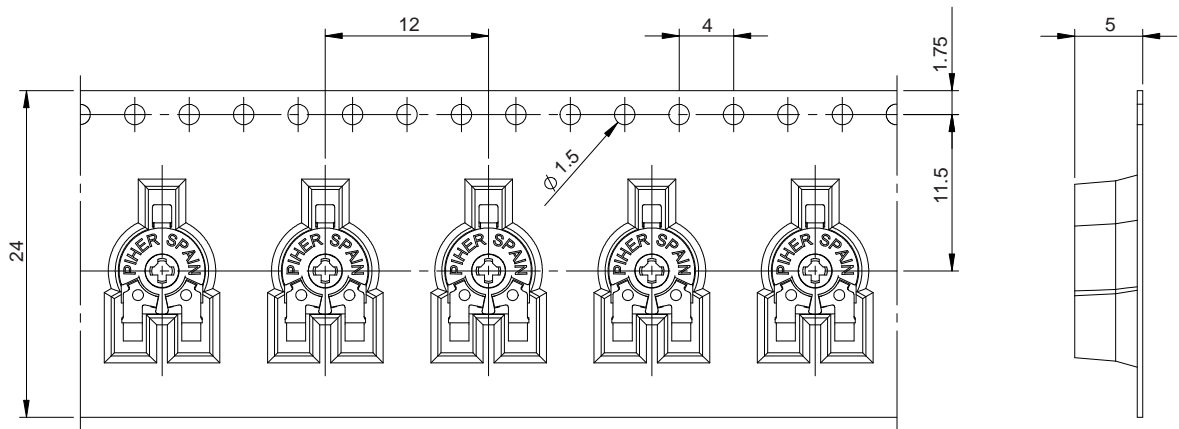
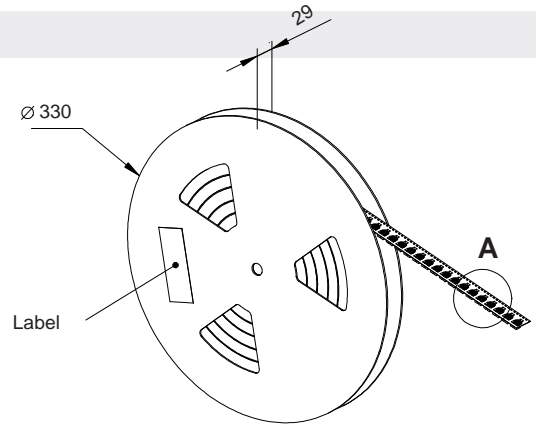
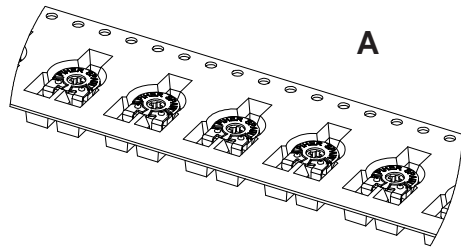

V50 and V55 models

BULK (1000pcs / Box)

EMBOSSED TAPE (1000pcs / Reel)

Models with factory-assembled knob will use a reel of 380mm diameter.

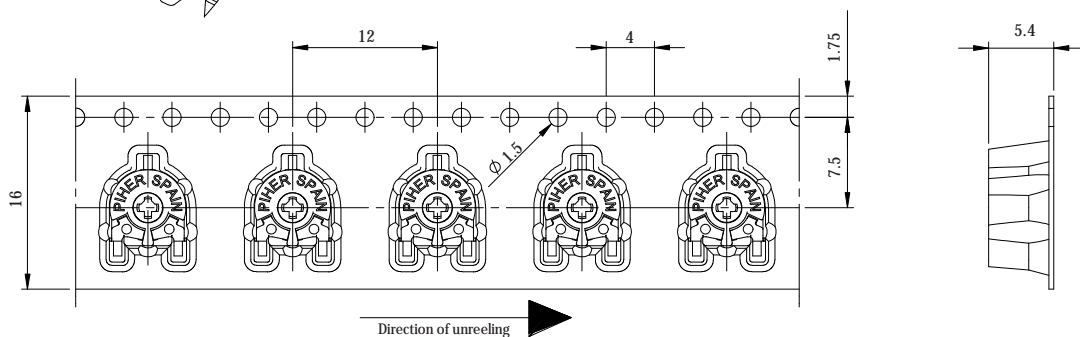
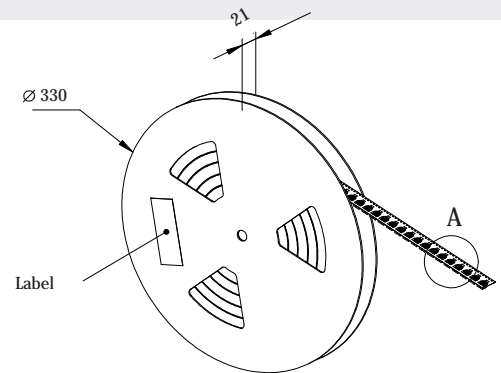
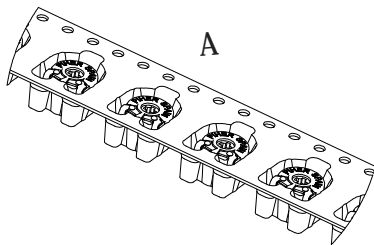

6mm carbon potentiometer PS-6

Recommended reflow profile

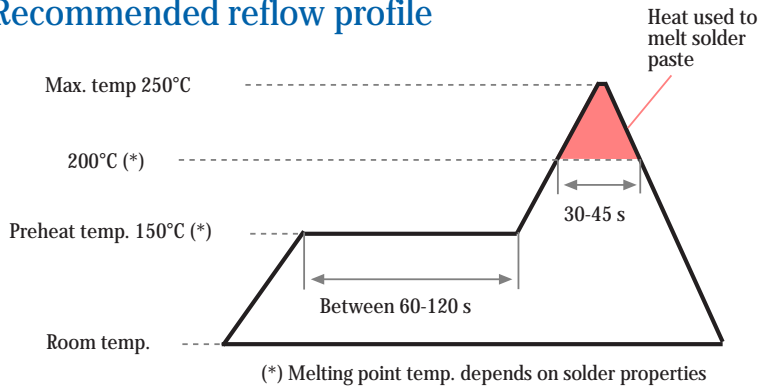

The recommended reflow profile is provided as a guideline. Optimal profile may differ due to oven type, assembly layout or other design or process variables. Customers should verify actual device performance in their specific application and reflow process. Please contact Piher if you require additional support.

Tests

| | | Typical variations |
|----------------------------------|---------------------------|--------------------|
| Electrical life | 1.000 h. @ 50°C; 0.10 W | ±10% |
| Mechanical life (cycles)* | 1000 @ 10 CPM ...15 CPM | ±10 % |
| Temperature coefficient | -40°C; +85°C | ±1500 ppm |
| Thermal cycling | 16 h. @ 90°C; 2h. @ -40°C | ±5 % |
| Damp heat | 500 h. @ 40°C @ 95% HR | ±15 % |
| Vibration (for each plane X,Y,Z) | 2 h. @ 10 Hz. ... 55 Hz. | ±3 % |

* Tests at room temperature. Other life cycles upon request. The mechanical life for detented versions is 100 cycles. Out of range values may not comply these results. Please confirm with the factory all the information before designing in.

Disclaimer

The product information in this catalogue is for reference purposes. Please consult for the most up to date and accurate design information.

Piher Sensors & Controls S.A., its affiliates, agents, and employees, and all persons acting on its or their behalf (collectively, "Piher"), disclaim any and all liability for any errors, inaccuracies or incompleteness contained herein or in any other disclosure relating to any product described herein.

Piher disclaims any and all liability arising out of the use or application of any product described herein or of any information provided herein to the maximum extent permitted by law. The product specifications do not expand or otherwise modify Piher's terms and conditions of sale, including but not limited to the warranty expressed therein, which apply to these products.

No licence, express or implied, by estoppel or otherwise, to any intellectual property rights is granted by this document or by any conduct of Piher.

The products shown herein are not designed for use in medical, life-saving, or life-sustaining applications unless otherwise expressly indicated. Customers using or selling Piher products not expressly indicated for use in such applications do so entirely at their own risk and agree to fully indemnify Piher for any damages arising or resulting from such use or sale. Please contact authorised Piher personnel to obtain written terms and conditions regarding products designed for such applications.

Product names and markings noted herein may be trademarks of their respective owners.

Information contained in and/or attached to this catalogue may be subject to export control regulations of the European Community, USA, or other countries. Each recipient of this document is responsible to ensure that usage and/or transfer of any information contained in this document complies with all relevant export control regulations. If you are in any doubt about the export control restrictions that apply to this information, please contact the sender immediately. For any Piher Exports, Note: All products / technologies are EAR99 Classified commodities. Exports from the United States are in accordance with the Export Administration Regulations. Diversion contrary to US law is prohibited.

Piher is an Amphenol™ company.



All Piher products can be adapted to meet customer's requirements. Due to continuous process improvement, specifications are subject to change without notice. Please always use the latest updated datasheets and 3D models published at our website www.piher.net.



Recommended connections

Piher potentiometer's recommended connection circuit for a position sensor or control application. (voltage divider circuit electronic design)

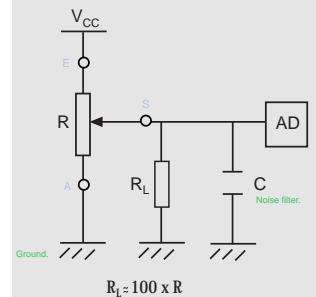

Contact

Piher Sensing Systems
Polígono Industrial Municipal
Vial T2 Nº22
31500 Tudela - Spain
Tel: +34-948-820450

sales@piher.net

www.piher.net

rev100620

Mouser Electronics

Authorized Distributor

Click to View Pricing, Inventory, Delivery & Lifecycle Information:

Amphenol:

[PS6MV50-203A3030](#) [PS6KV50-104A3030](#) [PS6MV50-103A3030](#) [PS6KV50-104A3030-PM](#) [PS6KV55-103A3030](#)
[PS6MV55-104A3030](#) [PS6KV55-105A3030](#) [PS6KV55-503A3030](#) [PS6KV50-105A3030](#) [PS6WV55-104A3030-05-I-PM](#)
[PS6WV55-104A3030-06-I-PM](#) [PS6WV55-502A3030-05-I-PM](#) [PS6KV50-503A3030-I-PM](#) [PS6WV55-103A3030-06-I-PM](#)
[PS6KV50-103A3030-PM](#)