

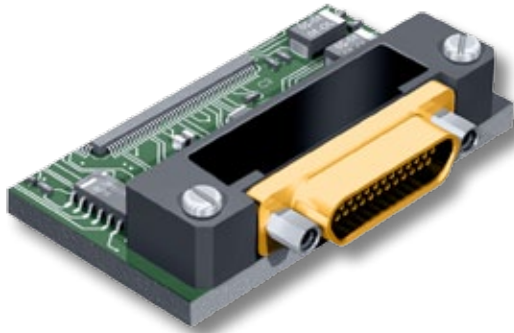

Micro-D Metal Shell Printed Circuit Board Connectors BR Style Right Angle Thru-Hole



High Performance—These connectors feature gold-plated TwistPin contacts for best performance. PC tails are .020 inch diameter. Specify nickel-plated shells or cadmium plated shells for best availability.

Solder-Dipped—Terminals are coated with SN63/Pb37 tin-lead solder for best solderability. Optional gold-plated terminals are available for RoHS compliance.

Front Panel or Rear Mountable—Can be installed through panels up to .125 inch thick. Specify rear panel mount jackposts.

HOW TO ORDER BR STYLE PCB MICRO-D CONNECTORS

Series	Shell Material and Finish	Insulator Material	Contact Layout	Contact Type	Termination Type	Jackpost Option	Threaded Insert Option	Terminal Length In Inches	Gold-Plated Terminal Mod Code	
MWDM	Aluminum Shell	L – LCP 30% Glass-Filled Liquid Crystal Polymer	9	P Pin	BR Board Right Angle	(Omit for None)	T	.080	These connectors are solder-dipped in 63/37 tin-lead solder. To delete the solder dip and change to gold-plated terminals, add code 513	
	1 – Cadmium		15					P – Jackpost		.110
	2 – Nickel		21	S Socket		Jackposts for Rear Panel Mounting	(Omit for Thru-Hole)	Threaded Insert In Board Mount Hole		.125
	4 – Black Anodize		25					.140		
	5 – Gold		31					.150		
	6 – Chem Film		37					.172		
	Stainless Steel Shell	3 – Passivated	51	R1 – .032" Panel	.190	Length in Inches ± .015 (0.38)				
			100	R2 – .047" Panel	.250					
				R3 – .062" Panel						
				R4 – .093" Panel						
				R5 – .125" Panel						
Sample Part Number										
MWDM	1	L	- 15	P	BR	R3		- .110		

MICRO-D JACKPOST OPTIONS

No Designator	P	R1 Thru R5
<p>HEX NUT EPOXY FILL</p>		<p>Panel</p>
<p>Thru-Hole For use with Glennair jackposts only. Order hardware separately. Install with threadlocking compound.</p>	<p>Standard Jackpost Factory installed, not intended for removal.</p>	<p>Jackpost for Rear Panel Mounting Shipped loosely installed. Install with permanent threadlocking compound.</p>

Micro-D Metal Shell Printed Circuit Board Connectors BR Style Right Angle Thru-Hole



Micro-D
PCB

PERFORMANCE SPECIFICATIONS

Current Rating	3 AMP
DWV	600 VAC Sea level
Insulation Resistance	5000 Megohms Minimum
Contact Resistance	8 Milliohms Maximum
Low Level Contact Resist.	32 Milliohms Maximum
Magnetic Permeability	2 μ Maximum
Operating Temperature	-55° C. to +150° C.
Shock, Vibration	50 g., 20g.
Mating Force	(10 Ounces) X (# of Contacts)

MATERIALS AND FINISHES

Connector Shell	Aluminum Alloy 6061 or Stainless Steel, 300 Series, passivated. See Ordering Info for Plating Options
Insulator, Tray	Liquid Crystal Polymer (LCP)
Interfacial Seal	Fluorosilicone Rubber, Blue
Pin Contact	Copper Alloy, Gold over Nickel Plating
Socket Contact	Copper Alloy, Gold Over Nickel Plating
PCB Terminals	Gold Plated Copper Alloy, Solder Dipped
Hardware	300 Series Stainless Steel
Encapsulant	Epoxy Resin Hysol EE4215

C

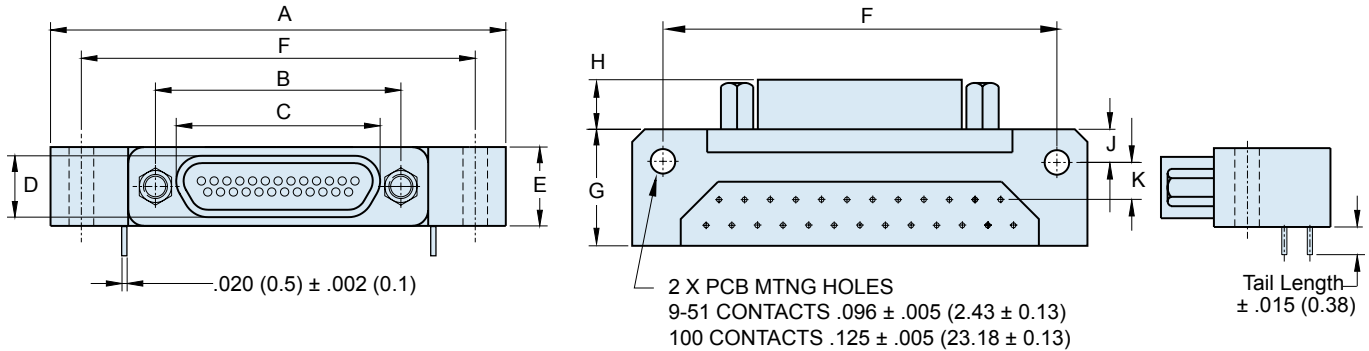

BR STYLE MICRO-D PCB CONNECTORS

Layout	A Max.		B		C Max.		D Max.		E Max.		F		G Max.		H		J		K	
	In.	mm.	In. ±.003	mm. ±0.08	In.	mm.	In.	mm.	In.	mm.	In. ±.007	mm. ±0.18	In.	mm.	In. ±.003	mm. ±0.08	In. ±.015	mm. ±0.38	In. ±.010	mm. ±0.25
9P	1.390	35.31	.565	14.35	.333	8.46	.184	4.67	.310	7.87	1.150	29.21	.465	11.81	.183	4.65	.125	3.18	.150	3.81
9S	1.390	35.31	.565	14.35	.400	10.16	.250	6.35	.310	7.87	1.150	29.21	.465	11.81	.195	4.95	.125	3.18	.150	3.81
15P	1.540	39.12	.715	18.16	.483	12.27	.184	4.67	.310	7.87	1.300	33.02	.465	11.81	.183	4.65	.125	3.18	.150	3.81
15S	1.540	39.12	.715	18.16	.551	14.00	.250	6.35	.310	7.87	1.300	33.02	.465	11.81	.195	4.95	.125	3.18	.150	3.81
21P	1.690	42.93	.865	21.97	.633	16.08	.184	4.67	.310	7.87	1.450	36.83	.465	11.81	.183	4.65	.125	3.18	.150	3.81
21S	1.690	42.93	.865	21.97	.701	17.81	.250	6.35	.310	7.87	1.450	36.83	.465	11.81	.195	4.95	.125	3.18	.150	3.81
25P	1.790	45.47	.965	24.51	.733	18.62	.184	4.67	.310	7.87	1.550	39.37	.465	11.81	.183	4.65	.125	3.18	.150	3.81
25S	1.790	45.47	.965	24.51	.801	20.35	.250	6.35	.310	7.87	1.550	39.37	.465	11.81	.195	4.95	.125	3.18	.150	3.81
31P	2.040	51.82	1.115	28.32	.883	22.43	.184	4.67	.310	7.87	1.800	45.72	.465	11.81	.183	4.65	.125	3.18	.150	3.81
31S	2.040	51.82	1.115	28.32	.951	24.16	.250	6.35	.310	7.87	1.800	45.72	.465	11.81	.195	4.95	.125	3.18	.150	3.81
37P	2.340	59.44	1.265	32.13	1.033	26.24	.184	4.67	.310	7.87	2.100	53.34	.465	11.81	.183	4.65	.125	3.18	.150	3.81
37S	2.340	59.44	1.265	32.13	1.101	27.96	.250	6.35	.310	7.87	2.100	53.34	.465	11.81	.195	4.95	.125	3.18	.150	3.81
51P	1.875	47.63	1.215	30.86	.983	24.97	.228	5.79	.351	8.92	1.600	40.64	.565	14.35	.183	4.65	.125	3.18	.150	3.81
51S	1.875	47.63	1.215	30.86	1.051	26.70	.296	7.52	.351	8.92	1.600	40.64	.565	14.35	.195	4.95	.125	3.18	.150	3.81
100P	2.780	70.60	1.800	45.72	1.383	35.13	.270	6.86	.394	10.01	2.500	63.50	.765	19.43	.183	4.65	.225	5.72	.150	3.81
100S	2.780	70.60	1.800	45.72	1.451	36.86	.333	8.46	.394	10.01	2.500	63.50	.765	19.43	.195	4.95	.225	5.72	.150	3.81

MICRO-D BR BOARD MOUNT CONNECTOR PCB LAYOUTS – PIN CONNECTORS

Patterns shown are for connector mounting side of PC board. 9 Thru 51 Contacts .096 (2.44) Diameter Mounting Holes, 100 Pin .125 (3.18) Diameter

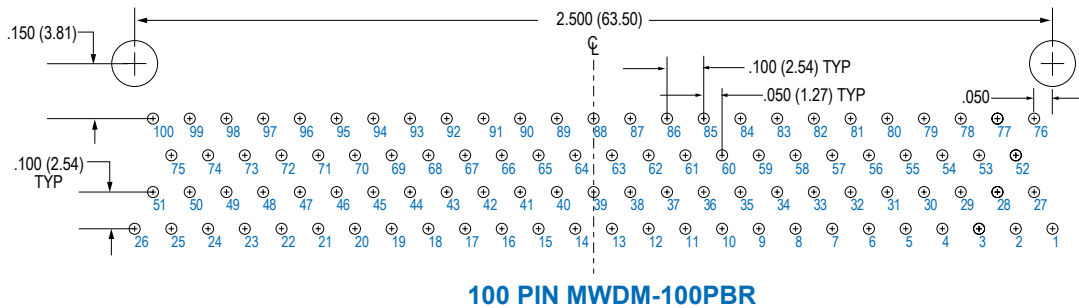
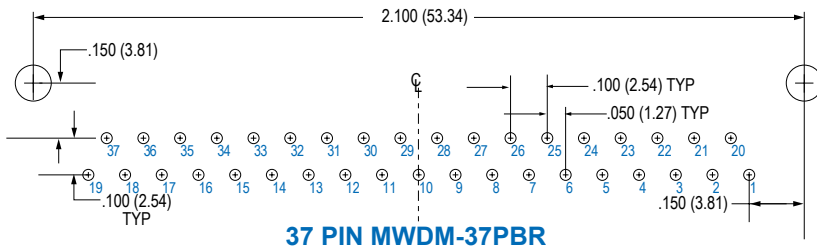
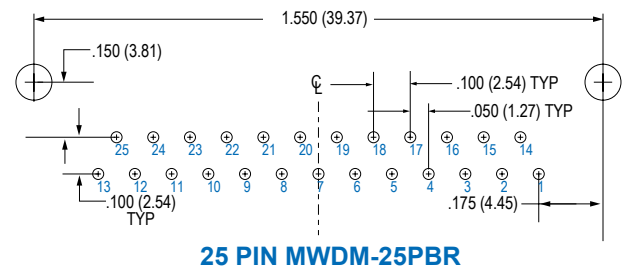
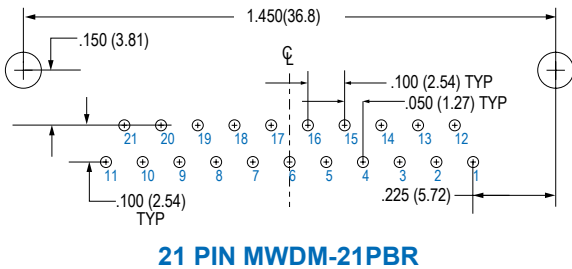
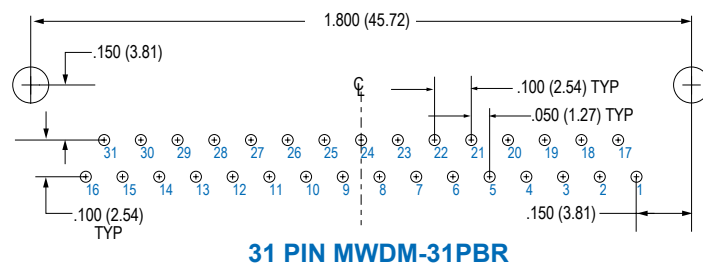
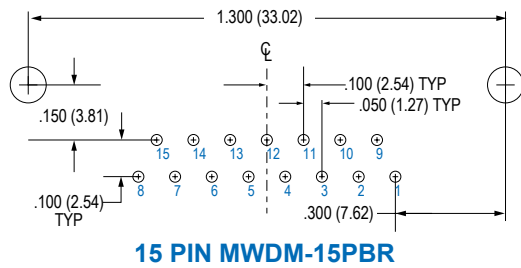
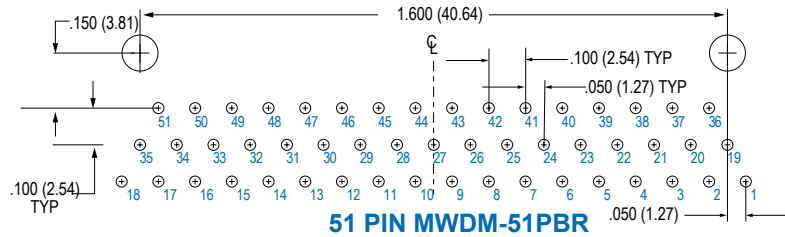
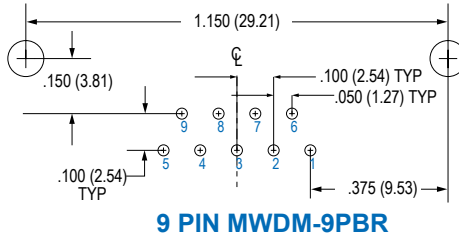

Micro-D Metal Shell Printed Circuit Board Connectors BR Style Right Angle Thru-Hole



MICRO-D BR BOARD MOUNT CONNECTOR PCB LAYOUTS – SOCKET CONNECTORS

Patterns shown are for connector mounting side of PC board. 9 Thru 51 Contacts .096 (2.44) Diameter Mounting Holes, 100 Pin .125 (3.18) Diameter

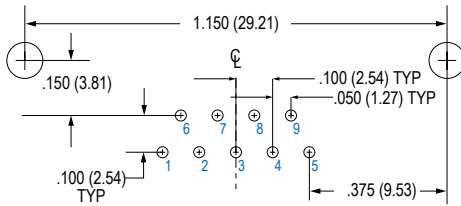

9 SOCKET MWDM-9SBR

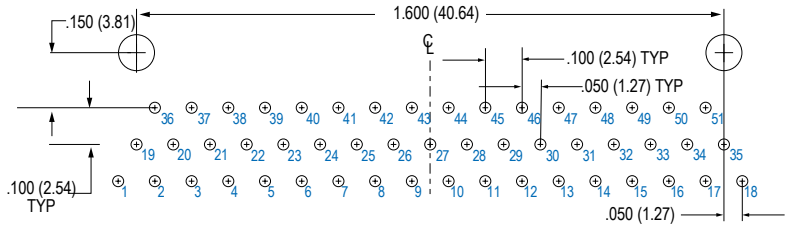

51 SOCKET MWDM-51SBR

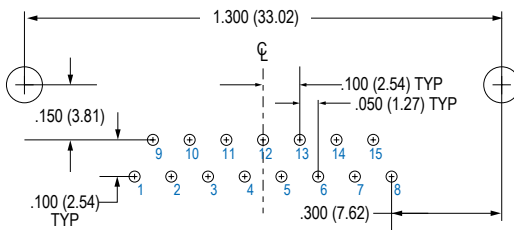

15 SOCKET MWDM-15SBR

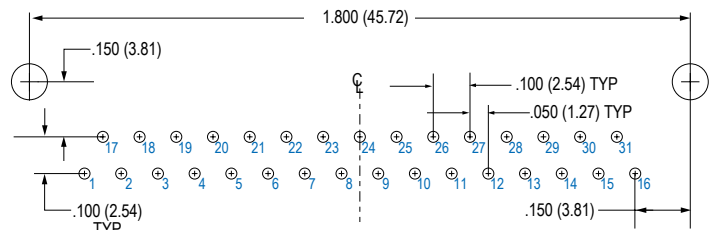

31 SOCKET MWDM-31SBR

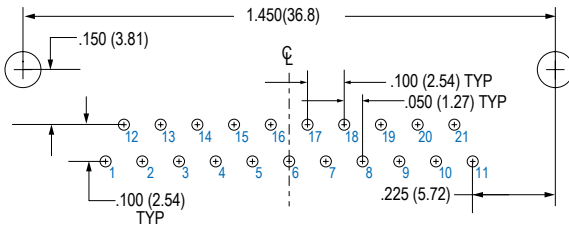

21 SOCKET MWDM-21SBR

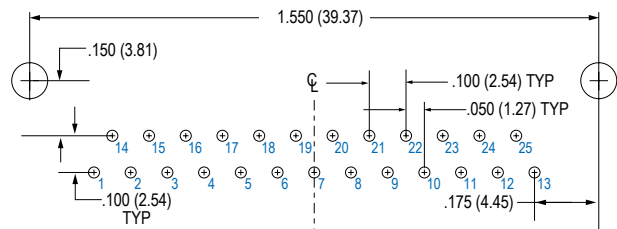

25 SOCKET MWDM-25SBR

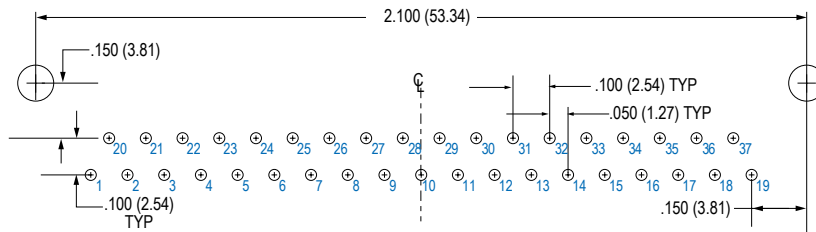

37 SOCKET MWDM-37SBR

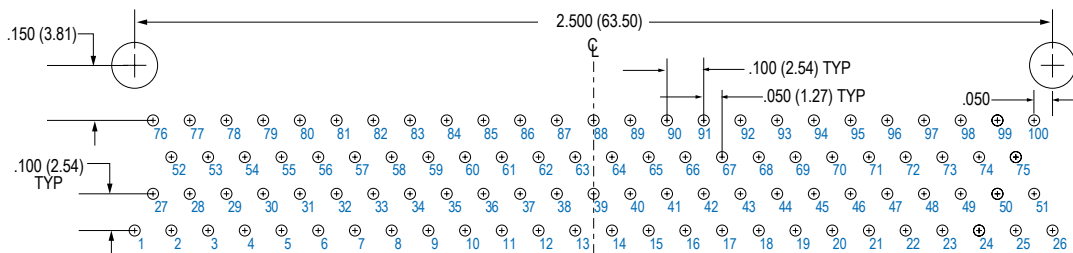

100 SOCKET MWDM-100SBR

Mouser Electronics

Authorized Distributor

Click to View Pricing, Inventory, Delivery & Lifecycle Information:

Glenair:

[MWDM2L-51PBRP-.110](#) [MWDM2L-51PBRPT-.190](#) [MWDM2L-51PBRPT-.150](#) [MWDM1L-21PBRP-.110](#) [MWDM1L-21PBRP-.150](#) [MWDM1L-21SBRP-.150](#) [MWDM1L-21SBRR4-.110](#) [MWDM1L-25PBRP-.150](#) [MWDM1L-25SBRP-.190](#) [MWDM1L-25SBRPT-.110](#) [MWDM1L-31PBRP-.150](#) [MWDM1L-31PBRPT-.110](#) [MWDM1L-31SBRP-.110](#) [MWDM1L-37PBRP-.110](#) [MWDM1L-37PBRP-.190](#) [MWDM1L-37SBR-.110](#) [MWDM1L-37SBRP-.190](#) [MWDM1L-51PBRP-.110](#) [MWDM1L-51PBRP-.140](#) [MWDM1L-51PBRP-.150](#) [MWDM1L-51PBRPT-.110](#) [MWDM1L-51SBRP-.140](#) [MWDM1L-51SBRP-.150](#) [MWDM1L-9PBRP-.110](#) [MWDM1L-9PBRP-.140](#) [MWDM1L-9PBRP-.150](#) [MWDM1L-9SBRP-.150](#) [MWDM1L-9SBRP-.190](#) [MWDM1L-9SBRPT-.125](#) [MWDM1L-9SBRPT-.140](#) [MWDM2L-100PBRR1-.110](#) [MWDM2L-100PBRR4-.150](#) [MWDM2L-100PBRR5-.110](#) [MWDM2L-100SBRP-.080](#) [MWDM2L-100SBRR1-.110](#) [MWDM2L-100SBRR5-.110](#) [MWDM1L-100PBRPT-.110](#) [MWDM1L-100PBRR3-.110](#) [MWDM1L-100SBRR1T-.125](#) [MWDM1L-15PBRP-.140](#) [MWDM1L-15PBRPT-.110](#) [MWDM1L-15SBR-.150](#) [MWDM2L-21PBRP-.150](#) [MWDM2L-37PBRP-.150](#) [MWDM2L-51PBRP-.172](#) [MWDM2L-51PBRP-.250](#) [MWDM2L-51PBRR1-.110](#) [MWDM2L-51SBR-.110](#) [MWDM2L-51SBRPT-.110](#) [MWDM2L-51SBRR3T-.110](#) [MWDM2L-51SBRR4-.110](#) [MWDM2L-51SBRR5T-.080](#) [MWDM2L-9PBRP-.190](#) [MWDM2L-9PBRPT-.190](#) [MWDM2L-9PBRR3T-.150](#) [MWDM2L-9SBR-.110](#) [MWDM2L-9SBRPT-.110](#) [MWDM2L-9SBRPT-.125](#) [MWDM2L-9SBRPT-.250](#) [MWDM2L-9SBRR4T-.110](#) [MWDM5L-21PBRPT-.110](#) [MWDM5L-21SBR-.190](#) [MWDM5L-21SBRP-.110](#) [MWDM5L-21SBRPT-.080](#) [MWDM5L-25PBRP-.150](#) [MWDM5L-25PBRR3T-.150](#) [MWDM5L-37SBRPT-.110](#) [MWDM5L-37SBRR3T-.110](#) [MWDM5L-51PBRP-.150](#) [MWDM5L-51PBRR3-.190](#) [MWDM6L-15PBRPT-.150](#) [MWDM6L-9PBRPT-.150](#) [MWDM1L-15PBRP-.190](#) [MWDM1L-15SBRP-.190](#) [MWDM1L-21SBR-.250](#) [MWDM1L-25PBRP-.080](#) [MWDM1L-25SBR-.080](#) [MWDM1L-25SBRP-.080](#) [MWDM2L-21PBRR3-.110](#) [MWDM2L-25PBRR2-.080](#) [MWDM2L-37PBRR5T-.080](#) [MWDM2L-51PBRR3-.110](#) [MWDM3L-21SBR-.250](#) [MWDM3L-25PBRR2-.080](#) [MWDM3L-51SBRPT-.250](#) [MWDM3L-9SBRR3-.110](#) [MWDM4L-25PBRP-.080](#) [MWDM4L-37SBRP-.150](#) [MWDM5L-25SBR-.080](#) [MWDM1L-31SBRP-.080](#) [MWDM1L-37PBRP-.080](#) [MWDM1L-9SBRPT-.150](#) [MWDM2L-15PBRP-.250](#) [MWDM2L-15PBRPT-.110](#) [MWDM2L-15SBR-.172](#) [MWDM2L-15SBRP-.190](#) [MWDM2L-15SBRP-.250](#) [MWDM2L-15SBRPT-.190](#) [MWDM2L-21PBRP-.140](#) [MWDM2L-21PBRR5-.172](#)