

## QBDE084A0B Barracuda™ Series DC-DC Power Modules

40-60Vdc Input; 12.0Vdc, 84.0A, 1000W Output



### Applications

- Distributed power architectures
- Intermediate bus voltage applications
- Networking equipment
- Servers and storage applications
- Supercomputers
- Automatic Test Equipment

### Options

- Passive Droop Load Sharing (-P=option code)
- Negative Remote On/Off logic (1=option code, factory preferred)
- Auto-restart after fault shutdown (4=option code, factory preferred)
- Shorter pin length

### Description

The QBDE084A0B Barracuda™ series of dc-dc converters is a new generation of fully regulated DC/DC power modules designed to support 12.0Vdc intermediate bus applications where multiple low voltages are subsequently generated using point of load (POL) converters, as well as other application requiring a tightly regulated output voltage. The QBDE084A0B series operate from an input voltage range of 40 to 60Vdc and provide up to 1000W output power with a fully regulated output voltage of 12.0Vdc in an industry-standard, modified DOSA digital quarter brick. The converter incorporates digital control, synchronous rectification technology, a fully regulated control topology, and innovative packaging techniques to achieve full load efficiency exceeding 96.5% at 12.0Vdc output. This leads to lower power dissipations such that for many applications a heat sink is not required. Standard features include a heat plate to attach external heat sinks or contact a cold wall, on/off control, output overcurrent and over voltage protection, over temperature protection, input under and over voltage lockout and PMBus interface.

The output is fully isolated from the input, allowing versatile polarity configurations and grounding connections. Built-in filtering for both input and output minimizes the need for external filtering.

Barracuda is a trademark of General Electric Company

^ PMBus name and logo are registered trademarks of SMIF, Inc.

# UL is a registered trademark of Underwriters Laboratories, Inc.

† CSA is a registered trademark of Canadian Standards Association.

‡ VDE is a trademark of Verband Deutscher Elektrotechniker e.V.

⌘ IEEE and 802 are registered trademarks of the Institute of Electrical and Electronics Engineers, Incorporated.

§ This product is intended for integration into end-user equipment. All of the required procedures of end-use equipment should be followed.

\*\* ISO is a registered trademark of the International Organization of Standards.

### Features

- Compliant to RoHS Directive 2011/65/EU and amended Directive (EU) 2015/863.
- Compliant to REACH Directive (EC) No 1907/2006
- High and flat efficiency with peak efficiency 96.8%
- Input voltage range: 40-60V<sub>dc</sub>
- Delivers up to 1000W output power
- Fully regulated 12V output at all Vin
- Low output ripple and noise
- Industry standard, modified-DOSA Digital Quarter Brick: 58.4mm x 36.8mm x 15.2 mm (2.30in x 1.45in x 0.60in)
- Constant switching frequency
- Remote On/Off control
- Output over current/voltage protection
- Digital interface with PMBus™ Rev.1.2 compliance<sup>^</sup>
- Firmware update possible on installed module
- Over temperature protection
- Wide operating temperature range: -40°C to 85°C, continuous
- ANSI/UL\* 62368-1 and CAN/CSA† C22.2 No. 62368-1 Recognized, DIN VDE‡ 0868-1/A11:2017 (EN62368-1:2014/A11:2017)
- ISO\*\* 9001 and ISO14001 certified manufacturing facilities 50 Vdc Functional Isolation CE mark meets 2014/35/EU directive<sup>§</sup>
- Base plate (-H=option code, always required)

## QBDE084A0B Barracuda™ Series DC-DC Power Modules

40-60Vdc Input; 12.0Vdc,84.0A, 1000W Output

### Absolute Maximum Ratings

Stresses in excess of the absolute maximum ratings can cause permanent damage to the device. These are absolute stress ratings only; functional operation of the device is not implied at these or any other conditions in excess of those given in the operations sections of the Preliminary Data Sheet. Exposure to absolute maximum ratings for extended periods can adversely affect device reliability.

Parameter	Symbol	Min	Max	Unit
Input Voltage <sup>1</sup>				
Continuous	$V_{IN}$	-0.3	60	V <sub>dc</sub>
Operating transient up to 100 ms	$V_{IN}$		75	V <sub>dc</sub>
Non-operating continuous	$V_{IN}$		75	V <sub>dc</sub>
$V_{ON/OFF}$ to $V_{IN}(-)$	$V_{ON/OFF}$	—	14.5	V <sub>dc</sub>
ADDRx (pins 14,15) to SIG_GND (pin 10)		-0.5	3.8	V
Operating Ambient Temperature	$T_A$	-40	85	°C
Storage Temperature	$T_{stg}$	-40	125	°C
I/O Isolation Voltage <sup>2</sup> (100% factory Hi-Pot tested)	—	—	750	V <sub>dc</sub>

<sup>1</sup> Input over voltage protection will shut down the output voltage when the input voltage exceeds threshold level.

<sup>2</sup> Base plate is considered floating.

### Electrical Specifications

Unless otherwise indicated, specifications apply overall operating input voltage, resistive load, and temperature conditions.

Parameter	Device	Symbol	Min	Typ	Max	Unit
Operating Input Voltage		$V_{IN}$	40	50	60	V <sub>dc</sub>
Maximum Input Current ( $V_{IN}=40V$ , $I_o=I_{o,max}$ )		$I_{IN,max}$	—	—	27	A <sub>dc</sub>
Input No Load Current ( $V_{IN} = V_{IN,nom}$ , $I_o = 0$ , module enabled)	All	$I_{IN,No load}$		195		mA
Input Stand-by Current ( $V_{IN} = V_{IN,nom}$ , module disabled)	All	$I_{IN,stand-by}$			30	mA
External Input Capacitance	All		140	—	700	μF
Inrush Transient (for fuse sizing*)	All	$I^2t$	—	—	1	A <sup>2</sup> s
Input Terminal Ripple Current (Measured at module input pin with maximum specified input capacitance and < 500uH inductance between voltage source and input capacitance) 5Hz to 20MHz, $V_{IN}= 48V$ , $I_o= I_{o,max}$	All		—	900	—	mA <sub>rms</sub>
Input Ripple Rejection (120Hz)	All		—	25	—	dB

**CAUTION: This power module is not internally fused. An input line fuse must always be used.**

\*This power module can be used in a wide variety of applications, ranging from simple standalone operation to an integrated part of sophisticated power architecture, including hot-plug with no external inrush limiting. To preserve maximum flexibility, internal fusing is not included, however, to achieve maximum safety and system protection, always use an input line fuse. The safety agencies require a fast-acting fuse with a maximum rating of 30A in the ungrounded input lead of the power supply (see Safety Considerations section). Based on the information provided in this Data Sheet on inrush energy and maximum dc input current, the same type of fuse with a lower rating can be used. Refer to the fuse manufacturer's Data Sheet for further information.

### Electrical Specifications

Unless otherwise indicated, specifications apply overall operating input voltage, resistive load, and temperature conditions.

Parameter	Device	Symbol	Min	Typ	Max	Unit
Output Voltage Set-point ( $V_{IN}=48V$ , $I_o=42A$ , $T_A=25^{\circ}C$ ) (Adjustable via PMBus)	Without -P option	$V_{O,set}$	11.95	12.00	12.05	V <sub>dc</sub>
Output Voltage Set-point ( $V_{IN}=48V$ , $I_o=42A$ , $T_A=25^{\circ}C$ ) (Not Adjustable via PMBus)	-P Option	$V_{O,set}$	11.95	12.00	12.05	V <sub>dc</sub>
Output Voltage (Over all operating input voltage (40V to 60V), resistive load, and temperature conditions until end of life)	Without -P option	$V_o$	11.76	—	12.24	V <sub>dc</sub>
Output Voltage (Over all operating input voltage (40V to 60V), resistive load, and temperature conditions until end of life)	-P Option	$V_o$	11.50	—	12.50	V <sub>dc</sub>

## QBDE084A0B Barracuda™ Series DC-DC Power Modules

40-60Vdc Input; 12.0Vdc, 84.0A, 1000W Output

Output Regulation [ $V_{IN,min} = 40V$ ] Line ( $V_{IN} = V_{IN,min}$ to $V_{IN,max}$ ) Line ( $V_{IN} = V_{IN,min}$ to $V_{IN,max}$ ) Load ( $I_O = I_{O,min}$ to $I_{O,max}$ ) Load ( $I_O = I_{O,min}$ to $I_{O,max}$ ), Intentional Droop Temperature ( $T_A = -40^\circ C$ to $+85^\circ C$ )	w/o -P -P option w/o -P -P option All	— — — — —	0.2 0.5 0.2 0.4 2	— — — — —	% $V_{O,set}$ % $V_{O,set}$ % $V_{O,set}$ $V_{dc}$ % $V_{O,set}$
Output Ripple and Noise, $C_O = 660\mu F$ , $\frac{1}{2}$ Ceramic, $\frac{1}{2}$ PosCap ( $V_{IN} = V_{IN,nom}$ and $I_O = I_{O,min}$ to $I_{O,max}$ ) RMS (5Hz to 20MHz bandwidth) Peak-to-Peak (5Hz to 20MHz bandwidth)	All	— —	50 —	— 120	$mV_{rms}$ $mV_{pk-pk}$
External Output Capacitance (mix <20% ceramic, remainder electrolytic. For non-droop models (w/o -P), startup $I_O \leq 55A$ )	All	$C_{O,max}$	470	—	10,000 $\mu F$
Output Power	All	$P_O$	0	—	1000 W
Output Current	All	$I_O$	0	—	84 A
VOUT_OC_FAULT_LIMIT (Default) (Adjustable via PMBus)	All	$I_{O,lim}$	—	92	— A <sub>dc</sub>
Efficiency ( $V_{IN} = 48V$ , $T_A = 25^\circ C$ ) $I_O = 100\% I_{O,max}$ , $V_O = V_{O,set}$ $I_O = 50\% I_{O,max}$ to $90\% I_{O,max}$ , $V_O = V_{O,set}$	All All	$\eta$ $\eta$	— —	96.5 96.8	% %
Switching Frequency (Primary FETs)		fsw		160	kHz
Dynamic Load Response $di_O/dt = 1A/\mu s$ ; $V_{in} = V_{in,nom}$ ; $T_A = 25^\circ C$ ; (Tested with a $1.0\mu F$ ceramic, and $470\mu F$ capacitor at the load.) Load Change from $I_O = 50\%$ to $75\%$ of $I_{O,max}$ : Peak Deviation Settling Time ( $V_O < 10\%$ peak deviation) Load Change from $I_O = 75\%$ to $50\%$ of $I_{O,max}$ : Peak Deviation Settling Time ( $V_O < 10\%$ peak deviation)	All All	$V_{pk}$ $t_s$ $V_{pk}$ $t_s$	— — — —	500 300 500 300	$mV_{pk}$ $\mu s$ $mV_{pk}$ $\mu s$

### Isolation Specifications

Parameter	Symbol	Min	Typ	Max	Unit
Isolation Capacitance	$C_{iso}$	—	10	—	nF
Isolation Resistance	$R_{iso}$	10	—	—	MΩ

### General Specifications

Parameter	Device	Symbol	Typ	Unit
Calculated Reliability Based upon Telcordia SR-332 Issue 3: Method I, Case 3, ( $I_O = 80\% I_{O,max}$ , $T_c = 40^\circ C$ , Airflow = 200 LFM), 90% confidence	All	MTBF	8,596,325	Hours
	All	FIT	116.3	$10^9$ /Hours
Weight – with Base plate			90(3.17)	g (oz.)

## QBDE084A0B Barracuda™ Series DC-DC Power Modules

40-60Vdc Input; 12.0Vdc, 84.0A, 1000W Output

### Feature Specifications

Unless otherwise indicated, specifications apply overall operating input voltage, resistive load, and temperature conditions. See Feature Descriptions for additional information.

Parameter	Device	Symbol	Min	Typ	Max	Unit
Remote On/Off Signal Interface ( $V_{IN}=V_{IN, min}$ to $V_{IN, max}$ , Signal referenced to $V_{IN-}$ terminal) Negative Logic ("1" device code suffix): Logic Low = module On; Logic High = module Off Positive Logic (no device code suffix): Logic Low = module Off; Logic High = module On Logic Low (pull down to $V_{IN(-)}$ externally) Voltage Sink current ( $V_{in}=56V$ ) Logic High (default; pulled up internally) Internal pull-up voltage Optional external applied voltage Leakage current of external pull-down device ( $V_{on/off}=2.4V$ )	All All All All All	$V_{on/off}$ $I_{on/off}$ $V_{on/off}$ $V_{on/off}$ $I_{on/off}$	-0.3 — 2.4 2.4 —	— 150 5 — —	0.8 200 8.2 14.5 130	$V_{dc}$ $\mu A$ $V_{dc}$ $V_{dc}$ $\mu A$
Turn-On Delay and Rise Times ( $I_o=I_{o, max}$ , Adjustable via PMBus) $T_{delay}$ =Time until $V_o = 10\%$ of $V_{o, set}$ from either application of $V_{in}$ with Remote On/Off set to On (Enable with $V_{in}$ ); or operation of Remote On/Off from Off to On with $V_{in}$ already applied for at least 30 milli-seconds (Enable with on/off). * Increased $T_{delay}$ for parallel modules, with $I_{o, TOT} = 50\% I_{o, max}$	Without -P option -P option	$T_{delay, Enable with Vin}$ $T_{delay, Enable with on/off}$ $T_{delay, Enable with Vin}$ $T_{delay, Enable with on/off}$	— — — —	— — — —	85 45 85* 45*	ms ms ms ms
$T_{rise}$ =Time for $V_o$ to rise from 10% to 90% of $V_{o, set}$ , *Increased $T_{rise}$ for parallel modules when pre-bias $V_o$ exists at startup.	Without -P option -P option	$T_{rise}$ $T_{rise}$	— —	15 25	— —	ms ms
Load Sharing Current Balance (difference in output current across all modules with outputs in parallel, no load to full load)	-P option	$I_{diff}$	—	—	8	$A_{dc}$
VOUT_COMMAND (Adjustable via PMBus)	All	$V_{o, set}$	9.5		12.0	$V_{dc}$
VOUT_OV_FAULT_LIMIT (Adjustable via PMBus)	All	$V_{o, limit}$	$V_{o, set} + 2.5V$		$V_{o, set} + 4.0V$ up to 15.99V	$V_{dc}$
Overtemperature Protection (Adjustable via PMBus)	All	$T_{OTP, set}$	—	140	—	$^{\circ}C$
Input Undervoltage Lockout (Adjustable via PMBus) Turn-on Threshold Turn-off Threshold Hysteresis			— — 2	39 36.5	— —	$V_{dc}$ $V_{dc}$ $V_{dc}$
Input Overvoltage Lockout (Adjustable via PMBus) Turn-off Threshold [VIN_OV_FAULT_LIMIT] Turn-on Threshold (follows VIN_OV_FAULT_LIMIT -7V)			— 61	— —	68 —	$V_{dc}$ $V_{dc}$

## QBDE084A0B Barracuda™ Series DC-DC Power Modules

40-60Vdc Input; 12.0Vdc,84.0A, 1000W Output

### Digital Interface Specifications

Unless otherwise indicated, specifications apply overall operating input voltage, resistive load, and temperature conditions. See Feature Descriptions for additional information.

Parameter	Conditions	Symbol	Min	Typ	Max	Unit
<b>PMBus Signal Interface Characteristics</b>						
Input High Voltage (CLK, DATA)		$V_{IH}$	2.1		3.6	V
Input Low Voltage (CLK, DATA)		$V_{IL}$			0.8	V
Input high level current (CLK, DATA)		$I_{IH}$	-10		10	$\mu A$
Input low level current (CLK, DATA)		$I_{IL}$	-10		10	$\mu A$
Output Low Voltage (CLK, DATA, SMBALERT#)		$V_{OL}$			0.4	V
Output Low internal sink current (CLK, DATA)	$V_{OL}=0.4V$	$I_{OL}$	4			mA
Output Low internal sink current (SMBALERT#)	$V_{OL}=0.4V$	$I_{OL}$	2			mA
Output high level internal leakage current (DATA, SMBALERT#)	$V_{OUT}=3.6V$	$I_{OH}$	0		10	$\mu A$
Pin capacitance		$C_O$		0.7		pF
PMBus Operating frequency range (* 5-10 kHz to accommodate hosts not supporting clock stretching)	Slave Mode	FPMB	5*		400	kHz
<b>Measurement System Characteristics</b>						
Output current reading range		$I_{OUT(RNG)}$	1.6500		97	A
Output current reading blanking		$I_{OUT(BNK)}$	0		1.5875	A
Output current reading resolution		$I_{OUT(RES)}$		146		mA
Output current reading accuracy	$16.5A < I_{out} < 97A$	$I_{OUT(ACC)}$	-5.0	-1.4	3.0	%
Output current reading accuracy (absolute difference between actual and reported values)	$1.65A < I_{out} < 16.5A$	$I_{OUT(ACC)}$	-1.7		2.5	A
$V_{OUT}$ reading range		$V_{OUT(RNG)}$	0		15.9997	V
$V_{OUT}$ reading resolution		$V_{OUT(RES)}$		0.244		mV
$V_{OUT}$ reading accuracy		$V_{OUT(ACC)}$	-2.0	0.6	2.0	%
$V_{IN}$ reading range		$V_{IN(RNG)}$	0		127.875	V
$V_{IN}$ reading resolution		$V_{IN(RES)}$		125		mV
$V_{IN}$ reading accuracy		$V_{IN(ACC)}$	-4.0	0.8	4.0	%
Temperature reading resolution		$T_{(RES)}$		0.25		$^{\circ}C$
Temperature reading accuracy		$T_{(ACC)}$	-5.0		5.0	%

# QBDE084A0B Barracuda™ Series DC-DC Power Modules

40-60Vdc Input; 12.0Vdc, 84.0A, 1000W Output

## Characteristic Curves, 12.0V<sub>dc</sub> Output

The following figures provide typical characteristics for the QBDE084A0B (12.0V, 84.0A) at 25°C. The figures are identical for either positive or negative Remote On/Off logic.

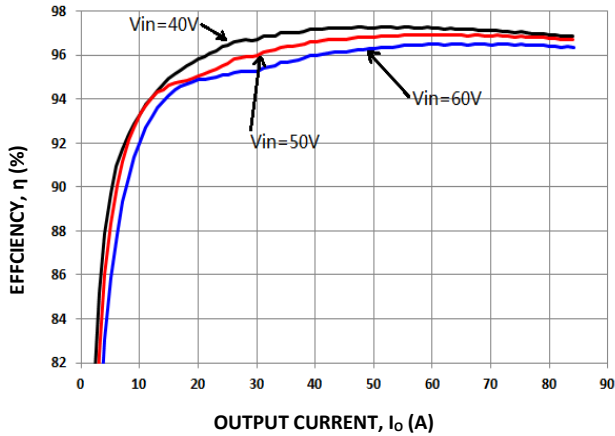

Figure 1. Typical Converter Efficiency vs. Output Current.

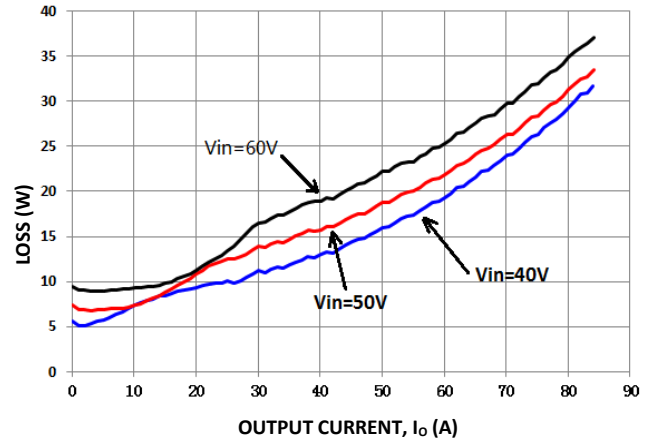

Figure 2. Typical Converter Loss vs. Output Current.

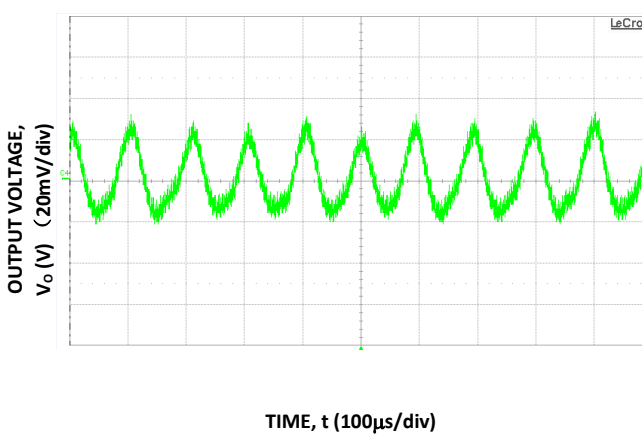

Figure 3. Typical Output Ripple and Noise,  $I_o = I_{o,max}$ ,  $C_o=660\mu F$ .

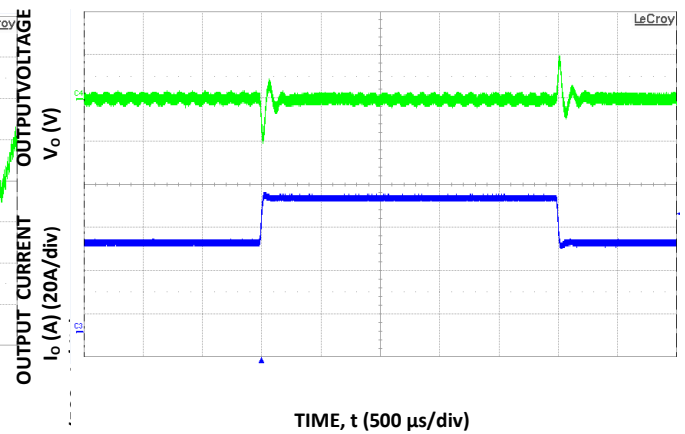

Figure 4. Typical Transient Response to 1.0A/ $\mu s$  Step Change in Load from 50% to 75% to 50% of Full Load,  $C_o=470\mu F$  and 50 V<sub>dc</sub> Input.

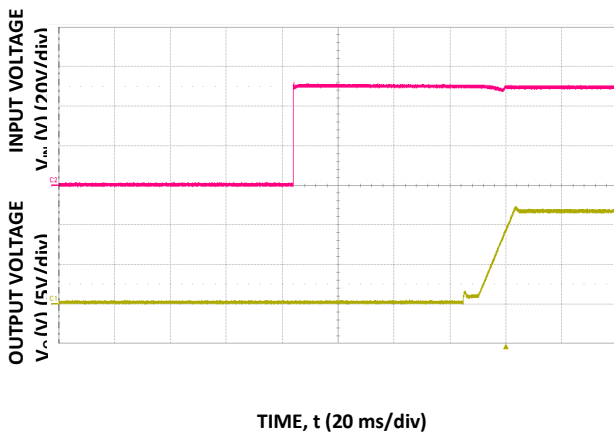

Figure 5. Typical Start-Up Using Vin with Remote On/Off enabled, negative logic version, without the -P option shown,  $I_o = I_{o,max}$ .

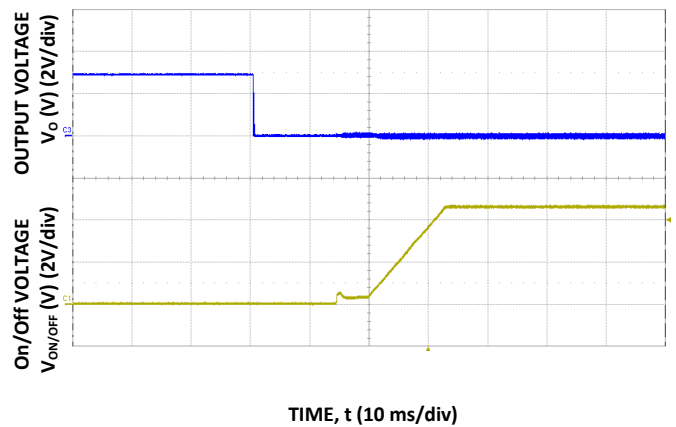

Figure 6. Typical Start-Up Using Remote On/Off with Vin applied, negative logic version, without the -P option shown,  $I_o = I_{o,max}$ .

# QBDE084A0B Barracuda™ Series DC-DC Power Modules

40-60Vdc Input; 12.0Vdc,84.0A, 1000W Output

## Characteristic Curves, 12.0V<sub>dc</sub> Output (continued)

The following figures provide typical characteristics for the QBDE084A0B (12.0V, 67A) at 25°C. The figures are identical for either positive or negative Remote On/Off logic.

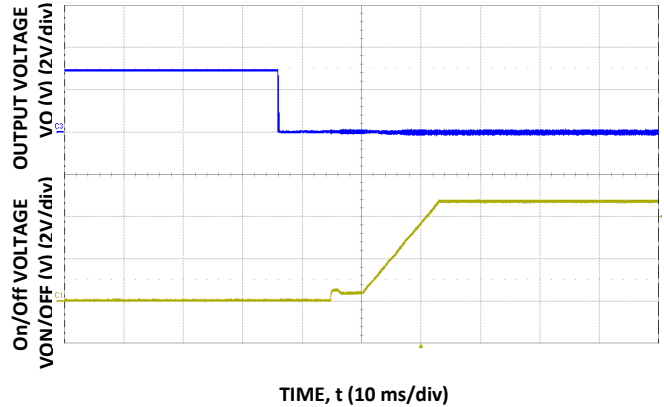
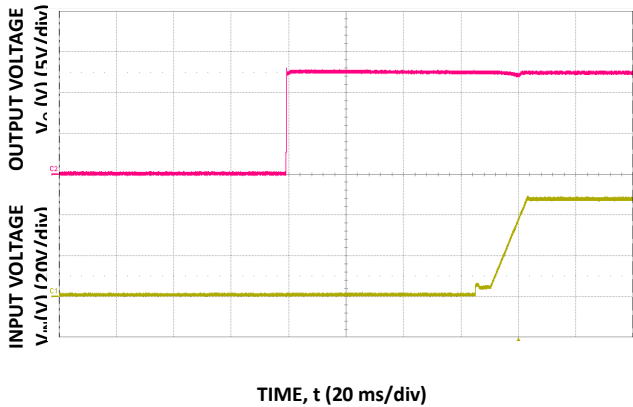

Figure 7. Typical Start-Up Using  $V_{in}$  with Remote On/Off enabled, negative logic version, with the  $-P$  option shown,  $I_o = 50\% I_{o,max}$ .

Figure 8. Typical Start-Up Using Remote On/Off with  $V_{in}$  applied, negative logic version, with the  $-P$  option shown,  $I_o = 50\% I_{o,max}$ .

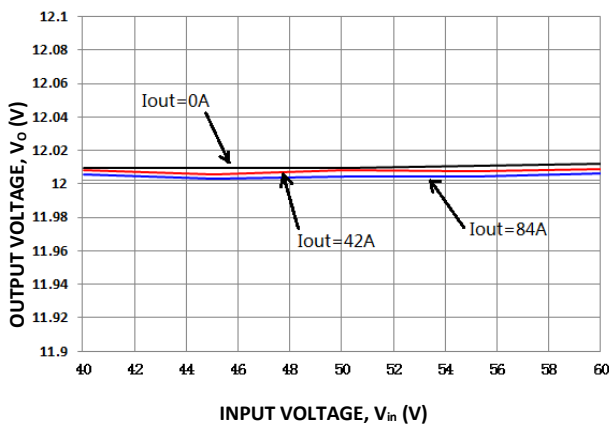

Figure 9. Typical Output Voltage Regulation vs. Input Voltage without the  $-P$  option.

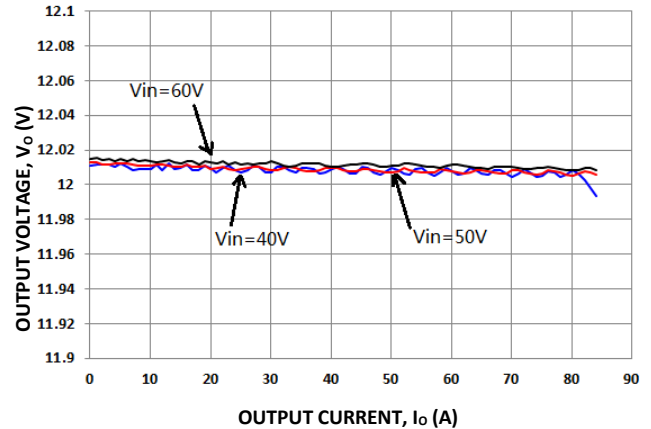

Figure 10. Typical Output Voltage Regulation vs. Output Current without the  $-P$  option.

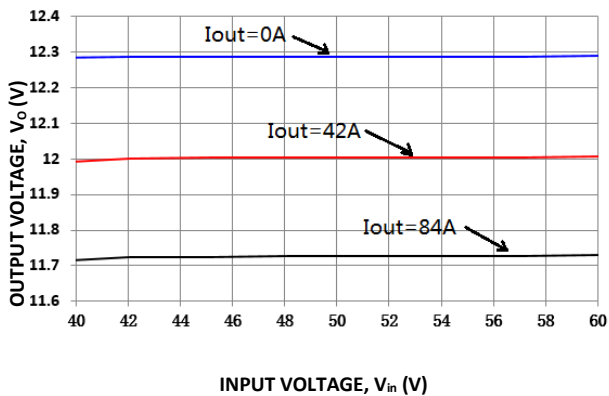

Figure 11. Typical Output Voltage Regulation vs. Input Voltage with the  $-P$  option.

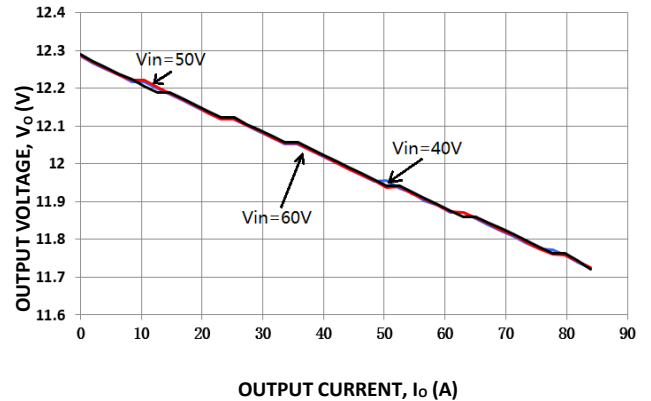
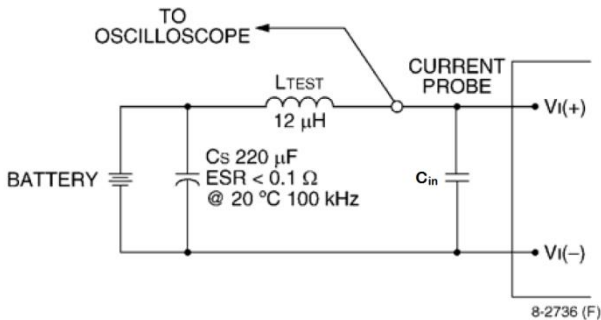

Figure 12. Typical Output Voltage Regulation vs. Output Current with the  $-P$  option.

# QBDE084A0B Barracuda™ Series DC-DC Power Modules

40-60Vdc Input; 12.0Vdc, 84.0A, 1000W Output

## Test Configurations



Note: Measure input reflected-ripple current with a simulated source inductance (LTEST) of 12 μH. Capacitor Cs offsets possible battery impedance. Measure current as shown above.

Figure 13. Input Reflected Ripple Current Test Setup.

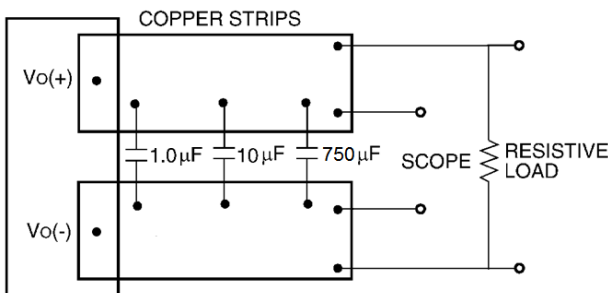

Note: Use a 1.0 μF ceramic capacitor, a 10 μF aluminum or tantalum capacitor and a 750 polymer capacitor. Scope measurement should be made using a BNC socket. Position the load between 51 mm and 76 mm (2 in. and 3 in.) from the module.

Figure 14. Output Ripple and Noise Test Setup.

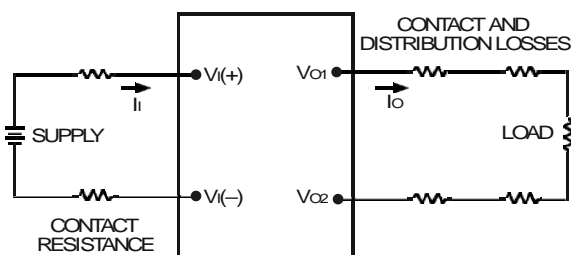

Note: All measurements are taken at the module terminals. When socketing, place Kelvin connections at module terminals to avoid measurement errors due to socket contact resistance.

$$\eta = \left( \frac{[V_{O(+)} - V_{O(-)}] I_{O}}{[V_{I(+)} - V_{I(-)}] I_{I}} \right) \times 100 \%$$

Figure 15. Output Voltage and Efficiency Test Setup.

## Design Considerations

### Input Source Impedance

The power module should be connected to a low ac-impedance source. Highly inductive source impedance can affect the stability of the power module. For the test configuration in Figure 13, a 660μF electrolytic capacitor, Cin, (ESR<0.7Ω at 100kHz), mounted close to the power module helps ensure the stability of the unit.

### Safety Considerations

For safety agency approval the power module must be installed in compliance with the spacing and separation requirements of the end-use safety agency standards, i.e., UL ANSI/UL 62368-1 and CAN/CSA C22.2 No. 62368-1 Recognized, DIN VDE 0868-1/A11:2017 (EN62368-1:2014/A11:2017)

If the input source is non-SELV (ELV or a hazardous voltage greater than 60 Vdc and less than or equal to 75Vdc), for the module’s output to be considered as meeting the requirements for safety extra-low voltage (SELV) or ES1, all of the following must be true:

- The input source is to be provided with reinforced insulation from any other hazardous voltages, including the ac mains.
- One VIN pin and one VOUT pin are to be grounded, or both the input and output pins are to be kept floating.
- The input pins of the module are not operator accessible.
- Another SELV or ES1 reliability test is conducted on the whole system (combination of supply source and subject module), as required by the safety agencies, to verify that under a single fault, hazardous voltages do not appear at the module’s output.

**Note:** Do not ground either of the input pins of the module without grounding one of the output pins. This may allow a non-SELV/ES1 voltage to appear between the output pins and ground.

The power module has safety extra-low voltage (SELV) or ES1 outputs when all inputs are SELV or ES1.

The input to these units is to be provided with a maximum 30A fast-acting (or time-delay) fuse in the ungrounded input lead.



# QBDE084A0B Barracuda™ Series DC-DC Power Modules

40-60Vdc Input; 12.0Vdc, 84.0A, 1000W Output

## Feature Descriptions

### Overcurrent Protection

To provide protection in a fault output overload condition, the module is equipped with internal current-limiting circuitry and can endure current limiting continuously. If the overcurrent condition causes the output voltage to fall greater than 3.0V from  $V_{o, set}$ , the module will shut down and remain latched off. The overcurrent latch is reset by either cycling the input power or by toggling the on/off pin for one second. If the output overload condition still exists when the module restarts, it will shut down again. This operation will continue indefinitely until the overcurrent condition is corrected.

A factory configured auto-restart option (with overcurrent and overvoltage auto-restart managed as a group) is also available. An auto-restart feature continually attempts to restore the operation until fault condition is cleared.

### Remote On/Off

The module contains a standard on/off control circuit reference to the  $V_{IN(-)}$  terminal. Two factory configured remote on/off logic options are available. Positive logic remote on/off turns the module on during a logic-high voltage on the ON/OFF pin, and off during a logic low. Negative logic remote on/off turns the module off during a logic high, and on during a logic low. Negative logic, device code suffix "1," is the factory-preferred configuration.

The On/Off circuit is powered from an internal bias supply, derived from the input voltage terminals. To turn the power module on and off, the user must supply a switch to control the voltage between the On/Off terminal and the  $V_{IN(-)}$  terminal ( $V_{on/off}$ ). The switch can be an open collector or equivalent (see Figure 16). The switch should maintain <0.8V while sinking up to 200 $\mu$ A. During a logic high when the switch is off, the maximum allowable leakage current at  $V_{on/off} = 2.4V$  is 130 $\mu$ A. If using an external voltage source, the maximum voltage  $V_{on/off}$  on the pin is 14.5V with respect to the  $V_{IN(-)}$  terminal.

If not using the remote on/off feature, perform one of the following to turn the unit on:

For negative logic, short ON/OFF pin to  $V_{IN(-)}$ .

For positive logic: leave ON/OFF pin open.

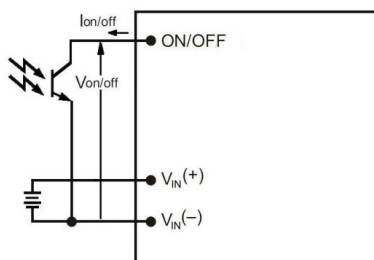

Figure 16. Remote On/Off Implementation.

### Output Overvoltage Protection

The module contains circuitry to detect and respond to output overvoltage conditions. If the overvoltage condition causes the output voltage to rise above the limit in the Specifications Table, the module will shut down and remain

latched off. The overvoltage latch is reset by either cycling the input power, or by toggling the on/off pin for one second. If the output overvoltage condition still exists when the module restarts, it will shut down again. This operation will continue indefinitely until the overvoltage condition is corrected.

A factory configured auto-restart option (with overcurrent and overvoltage auto-restart managed as a group) is also available. An auto-restart feature continually attempts to restore the operation until fault condition is cleared.

### Overtemperature Protection

These modules feature an overtemperature protection circuit to safeguard against thermal damage. The circuit shuts down the module when the maximum device reference temperature is exceeded. The module will automatically restart once the reference temperature cools by  $\sim 25^{\circ}C$ .

### Input Under/Over voltage Lockout

At input voltages above or below the input under/over voltage lockout limits, module operation is disabled. The module will begin to operate when the input voltage level changes to within the under and overvoltage lockout limits. However recovery from input undervoltage may be delayed by 4 seconds, or 13 seconds if the module is hot.

### Load Sharing

For higher power requirements, the QBDE084A0B-P module offers an optional feature for parallel operation (-P Option code). This feature provides a precise forced output voltage load regulation droop characteristic. The output set point and droop slope are factory calibrated to ensure optimum matching of multiple modules' load regulation characteristics. To implement load sharing, the following requirements should be followed:

- The  $V_{OUT(+)}$  and  $V_{OUT(-)}$  pins of all parallel modules must be connected together. Balance the trace resistance for each module's path to the output power planes, to ensure best load sharing and operating temperature balance.
- $V_{IN}$  must remain between 40V<sub>dc</sub> and 60V<sub>dc</sub> for droop sharing to be functional.
- It is permissible to use a common Remote On/Off signal to start all modules in parallel. However if spurious shutdowns occur at startup due to very low impedance between module outputs, the modules should be started sequentially instead, waiting at least the Turn-On Delay Time + Rise Time before starting the next module.
- These modules contain means to block reverse current flow upon start-up, when output voltage is present from other parallel modules, thus eliminating the requirement for external output ORing devices. Modules with the -P option may automatically increase the Turn On delay,  $T_{delay}$ , as specified in the Feature Specifications Table, if output voltage is present on the output bus at startup.
- When parallel modules startup into a pre-biased output, e.g. partially discharged output capacitance, the  $T_{rise}$  is automatically increased, as specified in the Feature Specifications Table, to ensure graceful startup.
- Ensure that the total load is <50%  $I_{O,MAX}$  (for a single module) until all parallel modules have started. Full load may be applied after  $Max T_{delay} + T_{rise}$ .

# QBDE084A0B Barracuda™ Series DC-DC Power Modules

40-60Vdc Input; 12.0Vdc, 84.0A, 1000W Output

- If fault tolerance is desired in parallel applications, output ORing devices should be used to prevent a single module failure from collapsing the load bus.

## Feature Descriptions (continued)

### Power Good, PG

The QBDE084A0B module provides a Power Good (PG) feature, which compares the module's output voltage to the module's POWER\_GOOD\_ON and POWER\_GOOD\_OFF values. These values are adjustable via PMBus. PG is asserted when the module's output voltage is above the POWER\_GOOD\_ON value, and PG is de-asserted if any condition such as overtemperature, overcurrent or loss of regulation occurs that would result in the output voltage going below the POWER\_GOOD\_OFF value.

The PG signal, provided on pin C2, is implemented with an open-drain node, pulled up via a 10kΩ resistor to 3.3V internally. For Positive Logic PG (default), the PG signal is HI, when PG is asserted, and LO, when the PG is de-asserted. For Negative Logic PG, the PG signal is LO, when PG is asserted, and HI, when the PG is de-asserted.

The PMBus command MFR\_PGOOD\_POLARITY is used to set the logic polarity of the signal.

If not using the Power Good feature, the pin may be left N/C.

### Thermal Considerations

The power modules operate in a variety of thermal environments and sufficient cooling should be provided to help ensure reliable operation. Thermal considerations include ambient temperature, airflow, module power dissipation, and the need for increased reliability. A reduction in the operating temperature of the module will result in an increase in reliability. Heat-dissipating components are mounted on the top side of the module. Heat is removed by conduction, convection and radiation to the surrounding environment. Proper cooling can be verified by measuring the thermal reference temperature (TH1).

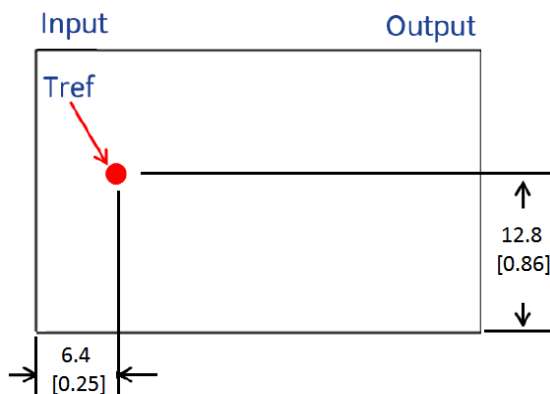

Figure 17. Location of the thermal reference temperature TH1 for base plate module.

Peak temperature occurs at the position indicated in Figure 17. For reliable operation, this temperature should not exceed TH1=105°C at any airflow condition. For extremely high reliability you can limit this temperature to a lower value. The output power of the module should not exceed the rated power for the module as listed in the Ordering Information table, or the derated power for the actual operating conditions as indicated in Figs. 19-24.

### Heat Transfer via Convection

The thermal data presented here is based on physical measurements taken in a wind tunnel, using automated thermo-couple instrumentation to monitor key component temperatures: FETs, diodes, control ICs, magnetic cores, ceramic capacitors, opto-isolators, and module PWB conductors, while controlling the ambient airflow rate and temperature. For a given airflow and ambient temperature, the module output power is increased, until one (or more) of the components reaches its maximum derated operating temperature, as defined in IPC-9592B. This procedure is then repeated for a different airflow or ambient temperature until a family of module output derating curves is obtained. Please refer to the Application Note "Thermal Characterization Process For Open-Frame Board-Mounted Power Modules" for a detailed discussion of thermal aspects including maximum device temperatures.

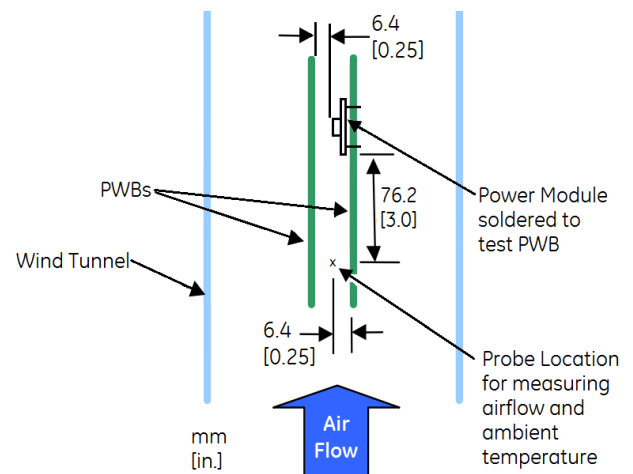

Figure 18. Thermal Test Setup

Increased airflow over the module enhances the heat transfer via convection. The thermal derating of figure 19- 24 shows the maximum output current that can be delivered by each module in the indicated orientation without exceeding the maximum TH1 temperature versus local ambient temperature (TA) for several air flow conditions.

# QBDE084A0B Barracuda™ Series DC-DC Power Modules

40-60Vdc Input; 12.0Vdc,84.0A, 1000W Output

## Thermal Considerations (continued)

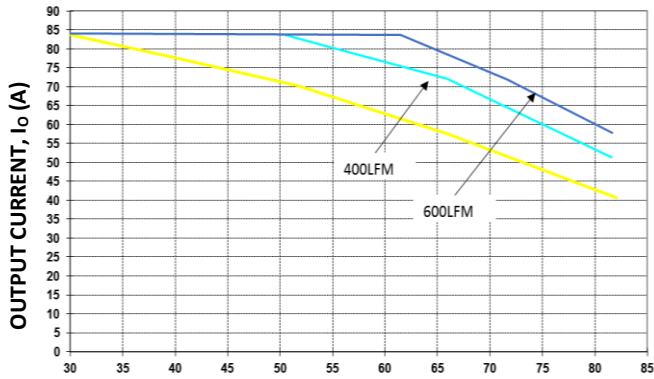

LOCAL AMBIENT TEMPERATURE,  $T_A$  (°C)

Figure 19. Output Current Derating for the Base Plate QBDE084A0Bxx-H in the Transverse Orientation; Airflow Direction for input- to input+ orientation;  $V_{in} = 50V$ .

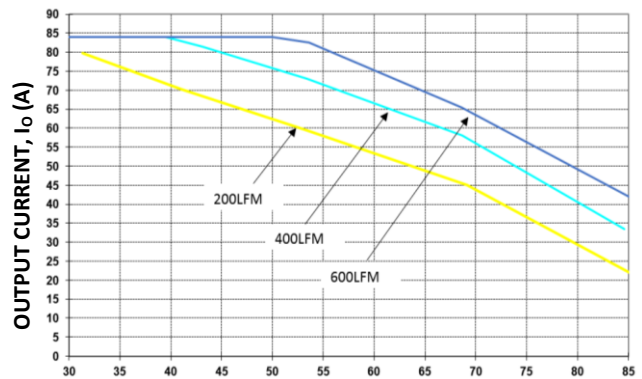

LOCAL AMBIENT TEMPERATURE,  $T_A$  (°C)

Figure 20. Output Current Derating for the Base Plate QBDE084A0Bxx-H in the Longitudinal Airflow Direction for input to output orientation;  $V_{in} = 50V$ .

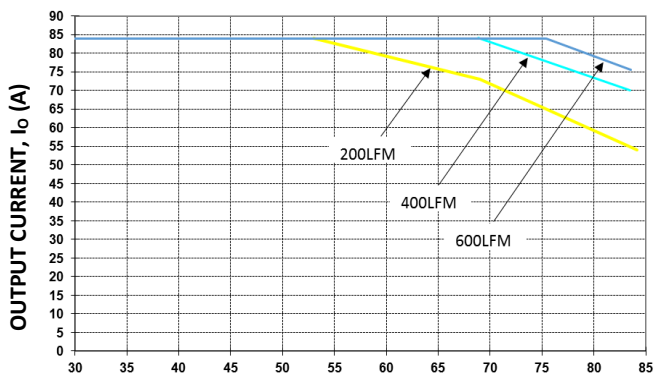

LOCAL AMBIENT TEMPERATURE,  $T_A$  (°C)

Figure 21. Output Current Derating for the Base Plate QBDE084A0Bxx-H+0.5" Heat Sink in the Transverse Orientation; Airflow Direction for input- to input+ orientation;  $V_{in} = 50V$ .

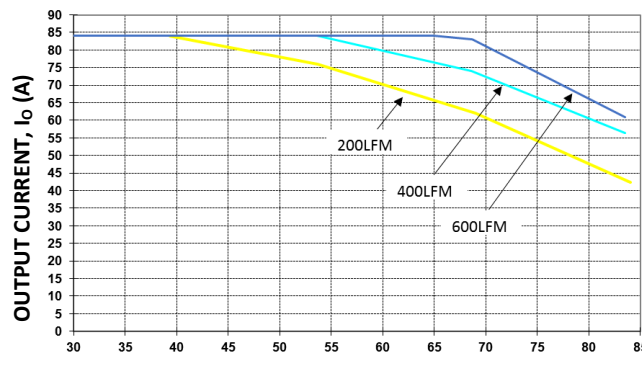

LOCAL AMBIENT TEMPERATURE,  $T_A$  (°C)

Figure 22. Output Current Derating for the Base Plate QBDE084A0Bxx-H+0.5" Heat Sink in the Longitudinal Airflow Direction for input to output orientation;  $V_{in} = 50V$ .

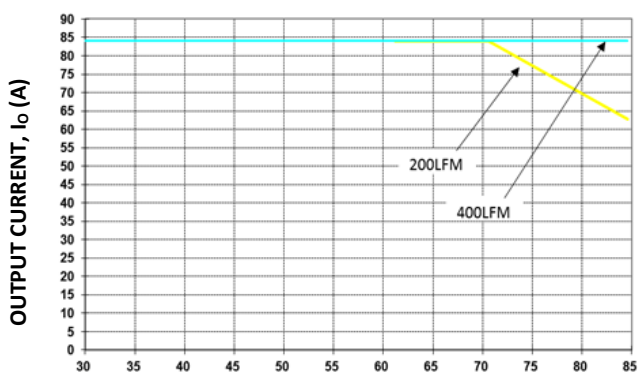

LOCAL AMBIENT TEMPERATURE,  $T_A$  (°C)

Figure 23. Output Current Derating for the Base Plate QBDE084A0Bxx-H+1.0" Heat Sink in the Transverse Orientation; Airflow Direction for input- to input+;  $V_{in} = 50V$ .

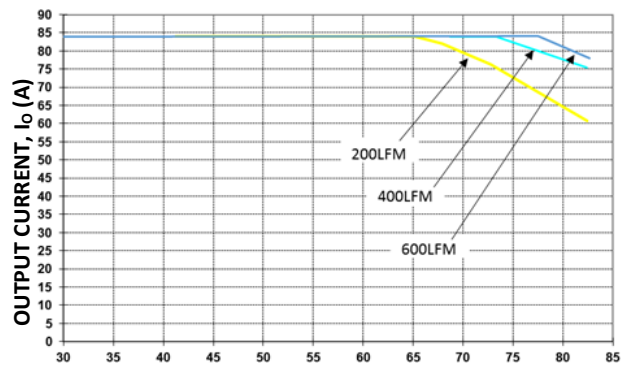

LOCAL AMBIENT TEMPERATURE,  $T_A$  (°C)

Figure 24. Output Current Derating for the Base Plate QBDE084A0Bxx-H+1.0" Heat Sink in the Longitudinal Airflow Direction for input to output orientation;  $V_{in} = 50V$ .

## QBDE084A0B Barracuda™ Series DC-DC Power Modules

40-60Vdc Input; 12.0Vdc, 84.0A, 1000W Output

### Layout Considerations

The QBDE084A0B power module series are low profile in order to be used in fine pitch system card architectures. As such, component clearance between the bottom of the power module and the mounting board is limited. Avoid placing copper areas on the outer layer directly underneath the power module. Also avoid placing via interconnects underneath the power module.

For additional layout guide-lines, refer to FLT012A0Z Preliminary Data Sheet.

If additional information is needed, please consult with your ABB Sales representative for more details

### Through-Hole Lead-Free Soldering Information

The RoHS-compliant, Z version, through-hole products use the SAC (Sn/Ag/Cu) Pb-free solder and RoHS-compliant components. The module is designed to be processed through single or dual wave soldering machines. The pins have a RoHS-compliant, pure tin finish that is compatible with both Pb and Pb-free wave soldering processes. A maximum preheat rate of 3°C/s is suggested. The wave preheat process should be such that the temperature of the power module board is kept below 210°C. For Pb solder, the recommended pot temperature is 260°C, while the Pb-free solder pot is 270°C max.

### MSL Rating

The QBDE084A0B modules have a MSL rating as indicated in the Device Codes table, last page of this document.

### Storage and Handling

The recommended storage environment and handling procedures for moisture-sensitive surface mount packages is detailed in J-STD-033 Rev. A (Handling, Packing, Shipping and Use of Moisture/Reflow Sensitive Surface Mount Devices). Moisture barrier bags (MBB) with desiccant are required for MSL ratings of 2 or greater. These sealed packages should not be broken until time of use. Once the original package is broken, the floor life of the product at conditions of  $\leq 30^{\circ}\text{C}$  and 60% relative humidity varies according to the MSL rating (see J-STD-060A). The shelf life for dry packed SMT packages will be a minimum of 12 months from the bag seal date, when stored at the following conditions:  $< 40^{\circ}\text{C}$ ,  $< 90\%$  relative humidity.

### Post Solder Cleaning and Drying Considerations

Post solder cleaning is usually the final circuit board assembly process prior to electrical board testing. The result of inadequate cleaning and drying can affect both the reliability of a power module and the testability of the finished circuit board assembly. For guidance on appropriate soldering, cleaning and drying procedures, refer to GE Board Mounted Power Modules: Soldering and Cleaning Application Note (AN04-001).

# QBDE084A0B Barracuda™ Series DC-DC Power Modules

40-60Vdc Input; 12.0Vdc,84.0A, 1000W Output

## EMC Considerations

The circuit and plots in Figure 26 shows a suggested configuration to meet the conducted emission limits of

EN55032 Class A , test with 54Vin condition. For further information on designing for EMC compliance, please refer to the FLTR100V20Z Preliminary Data Sheet.

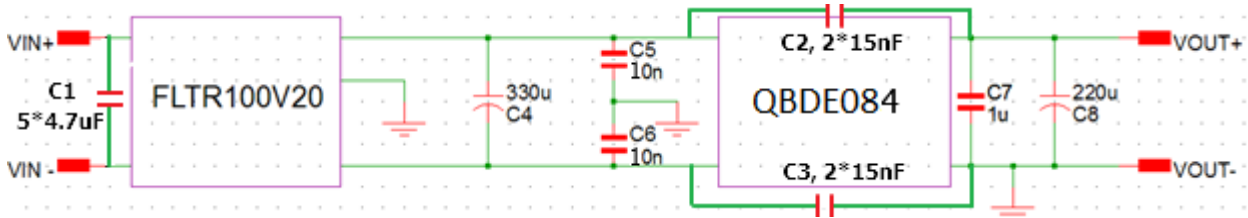

- C1 = 5\*4.7uF High Voltage cap
- C2 & C3 =2\* 0.015uF High Voltage cap
- C4 = 100uF/100V NCC KZN series + 220uF/100V Nichicon UBT series
- C5 & C6 = 0.01uF High Voltage cap
- C7= 1uF 100V 1210
- C8 = 470uF/25V NCC KZE series

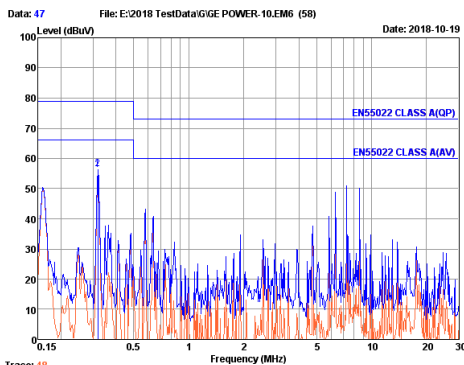

Data: 47 File: E:\2018 TestData\G\GE POWER-10.EM6 (58) Date: 2018-10-19

Trace: 48

Site : Audix (Shanghai) Shielded 3  
 Condition : EN55022 CLASS A(OP) ENV4200-2018 LINE  
 Project No. :  
 Applicant :  
 EUT : GE POWER  
 M/N : QBDE084  
 S/N : #47 -E  
 Power Supply : 220V/50Hz  
 Ambient : 23°C/52%RH  
 Test Line : L  
 Test Mode :  
 Test Engineer: Kevin  
 Memo :

	Freq	Level	Read Level	Cable Loss	LISN Factor	Limit Line	Over Limit	Remark	Pol/P
	MHz	dBuV	dBuV	dB	dB	dBuV	dB		
1	0.319	56.31	45.90	0.05	10.36	10.41	79.00	-22.69 QP	LINE
2	0.319	56.61	46.20	0.05	10.36	10.41	66.00	-9.39 Average	LINE

L line

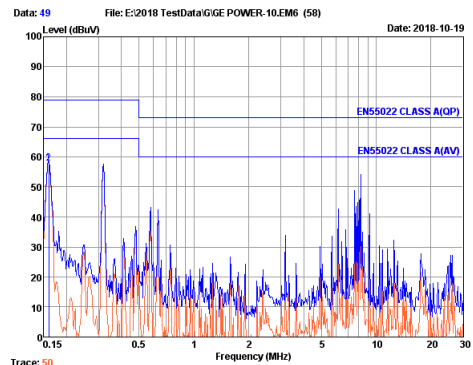

Data: 49 File: E:\2018 TestData\G\GE POWER-10.EM6 (58) Date: 2018-10-19

Trace: 50

Site : Audix (Shanghai) Shielded 3  
 Condition : EN55022 CLASS A(OP) ENV4200-2018 NEUTRAL  
 Project No. :  
 Applicant :  
 EUT : GE POWER  
 M/N : QBDE084  
 S/N : #47 -E  
 Power Supply : 220V/50Hz  
 Ambient : 23°C/52%RH  
 Test Line : N  
 Test Mode :  
 Test Engineer: Kevin  
 Memo :

	Freq	Level	Read Level	Cable Loss	LISN Factor	Limit Line	Over Limit	Remark	Pol/P
	MHz	dBuV	dBuV	dB	dB	dBuV	dB		
1	0.160	57.74	47.21	0.03	10.50	10.53	79.00	-21.26 QP	NEUTR
2	0.160	57.94	47.41	0.03	10.50	10.53	66.00	-8.06 Average	NEUTR

N line

## QBDE084A0B Barracuda™ Series DC-DC Power Modules

40-60Vdc Input; 12.0Vdc, 84.0A, 1000W Output

### Digital Feature Descriptions

#### PMBus Interface Capability

The QBDE084A0B series is equipped with a digital PMBus interface to allow the module to be configured and communicate with system controllers. Detailed timing and electrical characteristics of the PMBus can be found in the PMB Power Management Protocol Specification, Part 1, revision 1.2, available at <http://pmbus.org>. The QBDE084A0B supports both the 100kHz and 400kHz bus timing requirements. The QBDE084A0B shall stretch the clock, as long as it does not exceed the maximum clock LO period of 35ms. The QBDE084A0B will check the Packet Error Checking scheme (PEC) byte, if provided by the PMBus master, and include a PEC byte in all responses to the master. However, the QBDE084A0B does not require a PEC byte from the PMBus master.

The QBDE084A0B supports a subset of the commands in the PMBus 1.2 specification. Most all of the controller parameters can be programmed using the PMBus and stored as defaults for later use. All commands that require data input or output use the linear format. The exponent of the data words is fixed at a reasonable value for the command and altering the exponent is not supported. Direct format data input or output is not supported by the QBDE084A0B. The supported commands are described in greater detail below.

The QBDE084A0B contains non-volatile memory that is used to store configuration settings and scale factors. The settings programmed into the device are not automatically saved into this non-volatile memory though. The STORE\_DEFAULT\_ALL command must be used to commit the current settings to non-volatile memory as device defaults. The settings that are capable of being stored in non-volatile memory are noted in their detailed descriptions.

#### SMBALERT Interface Capability

The QBDE084A0B also supports the SMBALERT response protocol. The SMBALERT response protocol is a mechanism through which the QBDE084A0B can alert the PMBus master that it has an active status or alarm condition via pulling the SMBALERT pin to an active low. The master processes this condition, and simultaneously addresses all slaves on the PMBus through the Alert Response Address. Only the slave(s) that caused the alert (and that support the protocol) acknowledges this request. The master performs a modified receive byte operation to get the slave's address. At this point, the master can use the PMBus status commands to query the slave that caused the alert. Note: The QBDE084A0B can only respond to a single address at any given time. Therefore, the factory default state for the QBDE084A0B module is to retain its resistor programmed address, when it is in an ALERT active condition, and not respond to the ARA. This allows master systems, which do not support ARA, to continue to communicate with the slave QBDE084A0B using the programmed address and using the various READ\_STATUS commands to determine the cause for the SMBALERT. The CLEAR\_FAULTS command will retire the active SMBALERT. However, when the QBDE084A0B module is used in systems that do support ARA, Bit 4 of the MFR\_CPIN\_ARA\_CONFIG command can be used to reconfigure the module to utilize ARA. In this case, the QBDE084A0B will no longer respond to its programmed address, when in an ALERT active state. The master is expected to perform the modified received byte operation and retire the ALERT active signal. At this time, the QBDE084A0B will return to its resistor programmed address, allowing normal master-slave communications to proceed. The QBDE084A0B does not contain capability to arbitrate data bus contention caused by multiple modules responding to the modified received byte operation. Therefore, when the ARA is used in a multiple module PMBus application, it is necessary to have the QBDE084A0B module at the lowest programmed address in order for the host to properly determine all modules' address that are associated with an active SMBAlert. Please contact your GE sales representative for further assistance, and for more information on the SMBus alert response protocol, see the System Management Bus (SMBus) specification.

#### PMBus Addressing

The power module can be addressed through the PMBus using a device address. The module has 64 possible addresses (0 to 63 in decimal) which can be set using resistors connected from the ADDR0 and ADDR1 pins to GND. Note that some of these addresses (0 through 12, 40, 44, 45, and 55 in decimal) are reserved according to the SMBus specifications and may not be useable. The address is set in the form of two octal (0 to 7) digits, with each pin setting one digit. The ADDR1 pin sets the high order digit and ADDR0 sets the low order digit. The resistor values suggested for each digit are shown in Table 4 (1% tolerance resistors are recommended).

Table 4

Digit	Resistor Value (KΩ)
0	10
1	15.4
2	23.7
3	36.5
4	54.9
5	84.5
6	130
7	200

## QBDE084A0B Barracuda™ Series DC-DC Power Modules

40-60Vdc Input; 12.0Vdc,84.0A, 1000W Output

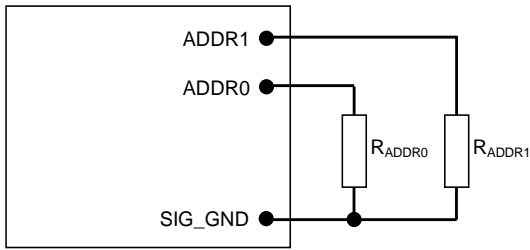
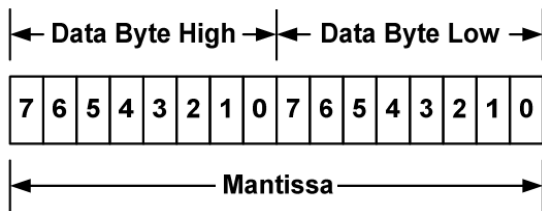

Figure 27. Circuit showing connection of resistors used to set the PMBus address of the module.

The user must know which I<sup>2</sup>C addresses are reserved in a system for special functions and set the address of the module to avoid interfering with other system operations. Both 100kHz and 400kHz bus speeds are supported by the module. Connection for the PMBus interface should follow the High-Power DC specifications given in section 3.1.3 in the SMBus specification V2.0 for the 400kHz bus speed or the Low Power DC specifications in section 3.1.2. The complete SMBus specification is available from the SMBus web site, [smbus.org](http://smbus.org).

### PMBus Data Formats

For commands that set or report any voltage thresholds related to output voltage (including VOUT\_COMMAND, VOUT\_MARGIN, POWER\_GOOD and READ\_VOUT), the module supports the “VOUT linear” data format consisting of a two-byte value with a 16-bit, unsigned mantissa, and a fixed exponent of -12. The format of the two data bytes is shown below:



The value of the number is then given by

$$\text{Value} = \text{Mantissa} \times 2^{-12}$$

For commands that set all other thresholds, voltages or report such quantities, the module supports the “linear” data format consisting of a two byte value with an 11-bit, two’s complement mantissa and a 5-bit, two’s complement exponent. The format of the two data bytes is shown below:

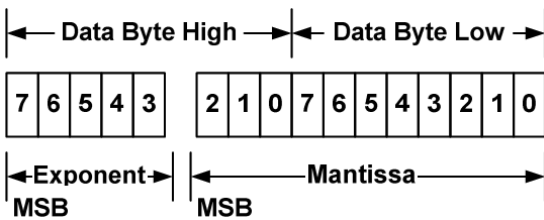

The value is of the number is then given by

$$\text{Value} = \text{Mantissa} \times 2^{\text{Exponent}}$$

For both formats, the “low” byte is transmitted first according to the PMBus and SMBus specifications.

### Write Protection

Write protection is enabled by default, to prevent accidentally changing settings. The MFR\_DEVICE\_TYPE (0xD0) command is used to disable or enable write protection as described below. To keep changes beyond the next removal of input voltage, the STORE\_DEFAULT\_ALL (0x11) command is used to save all settings to non-volatile memory.

### PMBus Enabled On/Off

The module can also be turned on and off via the PMBus interface. The OPERATION command is used to actually turn the module on and off via the PMBus, while the ON\_OFF\_CONFIG command configures the combination of analog ON/OFF pin input and PMBus commands needed to turn the module on and off. Bit [7] in the OPERATION command data byte enables the module, with the following functions:

- 0 : Output is disabled
- 1 : Output is enabled

## QBDE084A0B Barracuda™ Series DC-DC Power Modules

### 40-60Vdc Input; 12.0Vdc, 84.0A, 1000W Output

This module uses the lower five bits of the ON\_OFF\_CONFIG data byte to set various ON/OFF options as follows:

Bit Position	4	3	2	1	0
Access	r	r/w	r	r	r
Function	PU	CMD	CPR	POL	CPA
Default Value	1	1	1	1	1

PU: Factory set to 1. QBDE084A0B requires On/Off(i) pin to be connected to proper input rail for module to power up. This bit is used together with the CMD, CPR and ON bits to determine startup.

Bit Value	Action
1	Module does not power up until commanded by the analog ON/OFF pin and the OPERATION command as programmed in bits [2:0] of the ON_OFF_CONFIG register.

CMD: The CMD bit controls how the device responds to the OPERATION command.

Bit Value	Action
0	Module ignores the ON bit in the OPERATION command
1	Module responds to the ON bit in the OPERATION command

CPR: Factory set to 1. QBDE084A0B requires On/Off(i) pin to be connected to proper input rail for module to power up. This bit is used together with the CMD and ON bits to determine startup.

Bit Value	Action
1	Module requires the analog ON/OFF pin to be asserted to start the unit

### PMBus Adjustable Input Undervoltage Lockout

The module allows adjustment of the input under voltage lockout and hysteresis. The command VIN\_ON allows setting the input voltage turn on threshold, while the VIN\_OFF command sets the input voltage turn off threshold. For both the VIN\_ON and VIN\_OFF commands, possible values range from 32.000 to 46.000V in 0.125V steps. VIN\_ON must be 2.000V greater than VIN\_OFF.

Both the VIN\_ON and VIN\_OFF commands use the “Linear” format with two data bytes. The upper five bits [7:3] of the high data byte form the two’s complement representation of the exponent, which is fixed at –3 (decimal). The remaining 11 bits are used for two’s complement representation of the mantissa, with the 11<sup>th</sup> bit fixed at zero since only positive numbers are valid. The data associated with VIN\_ON and VIN\_OFF can be stored to non-volatile memory using the STORE\_DEFAULT\_ALL command.

### PMBus Adjustable Soft Start Delay and Rise Time

The soft start delay and rise time can be adjusted in the module via PMBus. The TON\_DELAY command sets the delay time in ms, and allows choosing delay times between 10ms and 500ms, with resolution of 0.5ms. The TON\_RISE command sets the rise time in ms, and allows choosing soft start times between 15ms and 500ms, with resolution of 0.5ms. When setting TON\_RISE, make sure that the charging current for output capacitors can be delivered by the module in addition to any load current to avoid nuisance tripping of the overcurrent protection circuitry during startup. Both the TON\_RISE and TON\_DELAY commands use the “Linear” format with two data bytes. The upper five bits [7:3] of the high data byte form the two’s complement representation of the exponent, which is fixed at –1 (decimal). The remaining 11 bits are used for two’s complement representation of the mantissa, with the 11<sup>th</sup> bit fixed at zero since only positive numbers are valid. The data associated with TON\_RISE and TON\_DELAY can be stored to non-volatile memory using the STORE\_DEFAULT\_ALL command.

### Output Voltage Adjustment Using the PMBus

The QBDE084A0B module output voltage set point is adjusted using the VOUT\_COMMAND. The output voltage setting uses the Linear data format, with the 16 bits of the VOUT\_COMMAND formatted as an unsigned mantissa, and a fixed exponent of -12 (decimal) (read from VOUT\_MODE).

$$V_{OUT} = \text{Mantissa} \times 2^{-12}$$

The range limits for VOUT\_COMMAND are 8.10V to 13.20V, and the resolution is 0.244mV.

The data associated with VOUT\_COMMAND can be stored to non-volatile memory using the STORE\_DEFAULT\_ALL command.



## QBDE084A0B Barracuda™ Series DC-DC Power Modules

40-60Vdc Input; 12.0Vdc, 84.0A, 1000W Output

### Output Voltage Margining Using the PMBus

The QBDE084A0B module can also have its output voltage margined via PMBus commands. The command VOUT\_MARGIN\_HIGH sets the margin high voltage, while the command VOUT\_MARGIN\_LOW sets the margin low voltage. Both the VOUT\_MARGIN\_HIGH and VOUT\_MARGIN\_LOW commands use the “Linear” mode with the exponent fixed at -12 (decimal). The data associated with VOUT\_MARGIN\_HIGH and VOUT\_MARGIN\_LOW can be stored to non-volatile memory using the STORE\_DEFAULT\_ALL command.

The module is commanded to go to the margined high or low voltages using the OPERATION command. Bits [5:2] are used to enable margining as follows:

00XX	: Margin Off
0110	: Margin Low (Act on Fault)
1010	: Margin High (Act on Fault)

### Measuring Output Voltage Using the PMBus

The module can provide output voltage information using the READ\_VOUT command. The command returns two bytes of data in the linear format, with the 16 bits of the READ\_VOUT formatted as an unsigned mantissa, and a fixed exponent of -12 (decimal).

During module manufacture, an offset correction value is written into the non-volatile memory of the module to null errors in the tolerance and A/D conversion of  $V_{OUT}$ . The command MFR\_VOUT\_READ\_CAL\_OFFSET can be used to read the offset - two bytes consisting of a signed 16-bit mantissa in two's complement format, using a fixed exponent of -12 (decimal). The resolution is 0.244mV. The corrected Output voltage reading is then given by:

$$V_{OUT}(\text{Read}) = [V_{OUT}(A/D) + MFR\_VOUT\_READ\_CAL\_OFFSET]$$

### Measuring Input Voltage Using the PMBus

The module can provide input voltage information using the READ\_VIN command. The command returns two bytes of data in the linear format. The upper five bits [7:3] of the high data byte form the two's complement representation of the exponent, which is fixed at -3 (decimal). The remaining 11 bits are used for two's complement representation of the mantissa, with the 11<sup>th</sup> bit fixed at zero since only positive numbers are valid.

During module manufacture, offset and gain correction values are written into the non-volatile memory of the module to null errors in the tolerance and A/D conversion of  $V_{IN}$ . The command MFR\_VIN\_READ\_CAL\_OFFSET can be used to read the offset - two bytes consisting of a five-bit exponent (fixed at -3) and a 11-bit mantissa in two's complement format. The resolution is 125mV. The command MFR\_VIN\_READ\_CAL\_GAIN can be used to read the gain correction - two bytes consisting of an unsigned 16 bit number. The resolution of this correction factor 0.000122. The corrected input voltage reading is then given by:

$$V_{IN}(\text{Read}) = [V_{IN}(A/D) \times (MFR\_VIN\_READ\_CAL\_GAIN / 8192)] + MFR\_VIN\_READ\_CAL\_OFFSET$$

### Measuring Output Current Using the PMBus

The module measures output current by using the output filter inductor winding resistance as a current sense element. The module can provide output current information using the READ\_IOUT command. The command returns two bytes of data in the linear format. The upper five bits [7:3] of the high data byte form the two's complement representation of the exponent, which is fixed at -3 (decimal). The remaining 11 bits are used for two's complement representation of the mantissa, with the 11<sup>th</sup> bit fixed at zero since only positive numbers are valid. Output current readings are blanked below 1.65A.

During module manufacture, offset and gain correction values are written into the non-volatile memory of the module to null errors in the tolerance and A/D conversion of  $I_{OUT}$ . The command MFR\_IOUT\_CAL\_OFFSET can be used to read the offset - two bytes consisting of a five-bit exponent (fixed at -3) and a 11-bit mantissa in two's complement format. The resolution is 125mA. The command MFR\_IOUT\_CAL\_GAIN can be used to read the gain correction - two bytes consisting of an unsigned 16 bit number. The resolution of this correction factor 0.000122. The READ\_IOUT command provides module average output current information. This command only supports positive current sourced from the module. If the converter is sinking current a reading of 0 is provided.

$$I_{OUT}(\text{Read}) = [I_{OUT}(A/D) \times (MFR\_IOUT\_CAL\_GAIN / 8192)] + MFR\_IOUT\_CAL\_OFFSET$$

## QBDE084A0B Barracuda™ Series DC-DC Power Modules

40-60Vdc Input; 12.0Vdc, 84.0A, 1000W Output

Note that the current reading provided by the module is corrected for temperature.

### Measuring the Temperature using the PMBus

The module can provide temperature information using the READ\_TEMPERATURE\_1 command. The command returns two bytes of data in the linear format. The upper five bits [7:3] of the high data byte form the two's complement representation of the exponent, which is fixed at -2 (decimal). The remaining 11 bits are used for two's complement representation of the mantissa.

Note that the module's temperature sensor is located close to the module hot spot TH<sub>1</sub> (see Thermal Considerations) and is subjected to temperatures higher than the ambient air temperature near the module. The temperature reading will be highly influenced by module load and airflow conditions.

### Reading the Status of the Module using the PMBus

The module supports a number of status information commands implemented in PMBus. However, not all features are supported in these commands. A X in the FLAG cell indicates the bit is not supported.

STATUS\_WORD : Returns two bytes of information with a summary of the module's fault/warning conditions.

#### High Byte

Bit Position	Flag	Default Value
15	VOUT fault	0
14	IOUT fault or warning	0
13	Input Voltage fault	0
12	X	0
11	POWER_GOOD# (is negated)	0
10	X	0
9	X	0
8	X	0

#### Low Byte

Bit Position	Flag	Default Value
7	X	0
6	OFF	0
5	VOUT Overvoltage	0
4	IOUT Overcurrent	0
3	VIN Undervoltage	0
2	Temperature	0
1	CML (Comm. Memory Fault)	0
0	X	0

STATUS\_VOUT : Returns one byte of information relating to the status of the module's output voltage related faults.

Bit Position	Flag	Default Value
7	VOUT OV Fault	0
6	X	0
5	X	0
4	X	0
Bit Position	Flag	Default Value
3	X	0
2	X	0
1	X	0
0	X	0

STATUS\_IOUT : Returns one byte of information relating to the status of the module's output current related faults.

Bit Position	Flag	Default Value
7	IOUT OC Fault	0
6	X	0
5	IOUT OC Warning	0
4	X	0
3	X	0

## QBDE084A0B Barracuda™ Series DC-DC Power Modules

40-60Vdc Input; 12.0Vdc, 84.0A, 1000W Output

2	X	0
1	X	0
0	X	0

STATUS\_INPUT : Returns one byte of information relating to the status of the module's input voltage related faults.

Bit Position	Flag	Default Value
7	VIN OV Fault	0
6	X	0
5	X	0
4	VIN UV Fault	0
3	Module Off (Low VIN)	0
2	X	0
1	X	0
0	X	0

STATUS\_TEMPERATURE : Returns one byte of information relating to the status of the module's temperature related faults.

Bit Position	Flag	Default Value
7	OT Fault	0
6	OT Warning	0
5	X	0
4	X	0
3	X	0
2	X	0
1	X	0
0	X	0

STATUS\_CML : Returns one byte of information relating to the status of the module's communication related faults.

Bit Position	Flag	Default Value
7	Invalid/Unsupported Command	0
6	Invalid/Unsupported Data	0
5	Packet Error Check Failed	0
4	X	0
3	X	0
2	X	0
1	X	0
0	X	0

### Summary of Supported PMBus Commands

This section outlines the PMBus command support for the QBDE084A0B bus converters. Each supported command is outlined in order of increasing command codes with a quick reference table of all supported commands included at the end of the section.

Each command will have the following basic information.

#### Command Name [Code]

Command support

Data format

Factory default

Additional information may be provided in tabular form or other format, if necessary.

#### OPERATION [0x01]

Command support: On/Off Immediate and Margins (Act on Fault). Soft off with sequencing not supported and Margins (Ignore Fault) not supported. Therefore bits 6, 3, 2, 1 and 0 set as read only at factory defaults.

Format	8 bit unsigned (bit field)							
Bit Position	7	6	5	4	3	2	1	0
Access	r/w	r	r/w	r/w	r	r	r	r
Function	ON/OFF		Bits[5:4]		Bits[3:2]		N/A	
Default Value	1	0	0	0	1	0	0	0

## QBDE084A0B Barracuda™ Series DC-DC Power Modules

40-60Vdc Input; 12.0Vdc, 84.0A, 1000W Output

### ON\_OFF\_CONFIG [0x02]

Command support: Bit 1 polarity will be set based upon module code [0=Negative on/off logic, 1=positive on/off logic to allow customer system to know hardware on/off logic

Format	8 bit unsigned (bit field)							
Bit Position	7	6	5	4	3	2	1	0
Access	r	r	r	r	r	r/w	r	r
Function	(reserved)			Bit 4 pu	Bit 3 cmd	Bit 2 cpr	Bit 1 pol	Bit 0 cpa
Default Value	0	0	0	1	1	1	module code	1

### CLEAR\_FAULTS [0x03]

Command support: All functionality

### STORE\_DEFAULT\_ALL[0x11]

Command support: All functionality – Stores operating parameters to EEprom memory.

Command requires ≤ 500ms to execute. Delay any additional commands to module for sufficient time to complete execution.

### RESTORE\_DEFAULT\_ALL[0x12]

Command support: All functionality – Restores operating parameters from EEprom memory.

Command requires ≤ 200ms to execute. Delay any additional commands to module for sufficient time to complete execution.

### VOUT\_MODE[0x20]

Command support: Supported. Factory default: 0x14 – indicates linear mode with exp = -12

Format	8 bit unsigned (bit field)							
Bit Position	7	6	5	4	3	2	1	0
Access	r	r	r	r	r	r	r	r
Function	Mode (linear)				2's complement exponent			
Default Value	0	0	0	1	0	1	0	0

### VOUT\_COMMAND [0x21]

Data format: 16 bit unsigned mantissa (implied exponent per VOUT\_MODE)

Factory default: 12.000V (  $12.00/2^{-12} \rightarrow 49,152 = 0xC000$  ) [standard code]

Range limits (max/min): 12.000/9.500V

Units: volt

Command support: Supported

### VOUT\_CAL\_OFFSET [0x23]

Range limits (max/min): +0.25/-0.25

Units: volt

Command support: read/write support, lockout per MFR\_DEVICE\_TYPE, functionality implemented

### VOUT\_MARGIN\_HIGH [0x25]

Range limits (max/min): 13.200/8.100V

Units: volt

Command support: read/write support, full functionality except "Ignore faults".

Note: Range cross-check - value must be greater than VOUT\_MARGIN\_LOW value.

### VOUT\_MARGIN\_LOW [0x26]

Range limits (max/min): 13.200/8.100V

Units: volt

Command support: read/write support, full functionality except "Ignore faults".

Note: Range cross-check - value must be less than VOUT\_MARGIN\_HIGH value.

### VOUT\_DROOP [0x28]

Range limits (max/min): 50.0/0

Units: mv/A

Command support: All functionality

### VIN\_ON [0x35]

Range limits (max/min): 46/40

Units: volt

## QBDE084A0B Barracuda™ Series DC-DC Power Modules

40-60Vdc Input; 12.0Vdc, 84.0A, 1000W Output

Command support: All functionality

Note: Special interlock checks between VIN\_ON and VIN\_OFF maintain a hysteresis gap of 2V minimum and do not allow the OFF level to be higher than and ON level

### VIN\_OFF [0x36]

Range limits (max/min): 46/40

Units: volt

Command support: All functionality

Note: Special interlock checks between VIN\_ON and VIN\_OFF maintain a hysteresis gap of 2V minimum and do not allow the OFF level to be higher than and ON level

### VOUT\_OV\_FAULT\_LIMIT [0x40]

Range limits (max/min): 15.99/10.9 (See note 2)

Units: volt

Command support: All functionality

Note:

1. Range cross-check – value must be greater than VOUT\_COMMAND value.
2. The maximum OV Fault Limit equals the output set point plus 3V, up to 15.99V. This is an automatic module protection feature that will override a user-set fault limit if the user limit is set too high.

### VOUT\_OV\_FAULT\_RESPONSE [0x41]

Command support:

- Response settings (bits RSP0:1) – only a setting of 10, unit shuts down and responds according to the retry settings below, is supported.
- Retry settings (bits RS0:2) – only settings of 000 (unit does not attempt to restart on fault) and 111 unit continuously restarts (normal startup) while fault is present until commanded off, bias power is removed, or another fault condition causes the unit to shut down.
- Delay time setting (bits DT0:2) – only DT0:2 = 0 (no delay) supported.

Default Settings: The default settings for the VOUT\_OV\_FAULT\_RESPONSE command is;

- The unit shuts down in response to a VOUT over voltage condition.
- The unit will continuously restart (normal startup) while the VOUT over voltage condition is present until it is commanded off, bias power is removed, or another fault condition causes the unit to shut down.
- The shutdown delay is set to 0 delay cycles.

Format	8 bit unsigned (bit field)							
Bit Position	7	6	5	4	3	2	1	0
Access	r	r	r/w	r/w	r/w	r	r	r
Function	RSP[1]	RSP[0]	RS[2]	RS[1]	RS[0]	DT[2]	DT[1]	DT[0]
Default Value	1	0	1	1	1	0	0	0

### IOUT\_OC\_FAULT\_LIMIT [0x46]

Range limits (max/min): 100/34

Units: amp

Command support: All functionality

Note: Range cross-check – value must be greater than IOUT\_OC\_WARN\_LIMIT value.

### IOUT\_OC\_FAULT\_RESPONSE [0x47]

Command support:

- Response settings (bits RSP0:1) – only settings of 11, unit shuts down and responds according to the retry settings below, is supported.
- Retry settings (bits RS0:2) – only settings of 000 (unit does not attempt to restart on fault) and 111 unit continuously restarts (normal startup) while fault is present until commanded off, bias power is removed, or another fault condition causes the unit to shut down.
- Delay time setting (bits DT0:2) – only DT0:2 = 0 (no delay) supported.

Default Settings: The default settings for the IOUT\_OC\_FAULT\_RESPONSE command is;

- The unit shuts down in response to an IOUT over current condition.
- The unit will continuously restart (normal startup) while the IOUT over current condition is present until it is commanded off, bias power is removed, or another fault condition causes the unit to shut down.

## QBDE084A0B Barracuda™ Series DC-DC Power Modules

40-60Vdc Input; 12.0Vdc, 84.0A, 1000W Output

- The shutdown delay is set to 0 delay cycles.

Format	8 bit unsigned (bit field)							
Bit Position	7	6	5	4	3	2	1	0
Access	r	r	r/w	r/w	r/w	r	r	r
Function	RSP[1]	RSP[0]	RS[2]	RS[1]	RS[0]	DT[2]	DT[1]	DT[0]
Default Value	1	1	1	1	1	0	0	0

### IOUT\_OC\_WARN\_LIMIT [0x4A]

Range limits (max/min): 90/25

Units: amp

Command support: read/write support, functionality complete

Note: Range cross-check – value must be less than IOUT\_OC\_FAULT\_LIMIT value.

### OT\_FAULT\_LIMIT [0x4F]

Range limits (max/min): 140/25

Units: degrees C.

Command support: All functionality

Note: Range cross-check – value must be greater than OT\_WARN\_LIMIT value.

### OT\_FAULT\_RESPONSE [0x50]

Command support:

- Response settings (bits RSP0:1) – only setting of 10, unit shuts down and responds according to the retry settings below.
- Retry settings (bits RS0:2) – only settings of 000 (unit does not attempt to restart on fault) and 111 unit continuously restarts (normal startup) while fault is present until commanded off, bias power is removed, or another fault condition causes the unit to shut down.
- Delay time setting (bits 0-2) – only DT0:2 = 0 (no delay) supported.

Default Settings: The default settings for the OT\_FAULT\_RESPONSE command is;

- The unit shuts down in response to an over-temperature condition.
- The unit will continuously restart (normal startup) while the over-temperature condition is present until it is commanded off, bias power is removed, or another fault condition causes the unit to shut down.
- The shutdown delay is set to 0 delay cycles.

Format	8 bit unsigned (bit field)							
Bit Position	7	6	5	4	3	2	1	0
Access	r	r	r/w	r/w	r/w	r	r	r
Function	RSP[1]	RSP[0]	RS[2]	RS[1]	RS[0]	DT[2]	DT[1]	DT[0]
Default Value	1	0	1	1	1	0	0	0

## QBDE084A0B Barracuda™ Series DC-DC Power Modules

40-60Vdc Input; 12.0Vdc,84.0A, 1000W Output

### OT\_WARN\_LIMIT [0x51]

Range limits (max/min): 125/25

Units: degrees C.

Command support: All functionality

Note: Range cross-check – value must be less than OT\_FAULT\_LIMIT value.

### VIN\_OV\_FAULT\_LIMIT [0x55]

Range limits (max/min): 90/48

Units: volt

Command support: All functionality

### VIN\_OV\_FAULT\_RESPONSE [0x56]

Command support:

Response settings (bits RSP0:1) – only settings of 11 (The device’s output is disabled while the fault is present.) is supported.

- Retry settings (bits RS0:2) – only settings of 000 (unit does not attempt to restart on fault).
- Delay time setting (bits 0-2) – only DT0:2 = 0 (no delay) supported.

Default Settings: The default settings for the VIN\_OV\_FAULT\_RESPONSE command are;

- The unit shuts down in response to a VIN over voltage condition.
- The unit will continuously prepare to restart (normal startup) while the VIN over voltage condition is present until it is commanded off, bias power is removed, the VIN over voltage condition is removed, or another fault condition causes the unit to shut down.
- The shutdown delay is set to 0 delay cycles.

Format	8 bit unsigned (bit field)							
Bit Position	7	6	5	4	3	2	1	0
Access	r	r	r	r	r	r	r	r
Function	RSP[1]	RSP[0]	RS[2]	RS[1]	RS[0]	DT[2]	DT[1]	DT[0]
Default Value	1	1	0	0	0	0	0	0

### POWER\_GOOD\_ON [0x5E]

Range limits (max/min): 11.7/9.2

Units: volt

Command support: full support

Note: Range cross-check – value must be greater than POWER\_GOOD\_OFF value by 1.6V.

### POWER\_GOOD\_OFF [0x5F]

Range limits (max/min): 10.1/7.6

Units: volt

Command support: full support

Note: Range cross-check – value must be less than POWER\_GOOD\_ON value by 1.6V.

### TON\_DELAY [0x60]

Range limits (max/min): 500/0

Units: milliseconds

Command support: full support

### TON\_RISE [0x61]

Range limits (max/min): 500/15

Units: milliseconds

Command support: full support

## QBDE084A0B Barracuda™ Series DC-DC Power Modules

40-60Vdc Input; 12.0Vdc, 84.0A, 1000W Output

### STATUS\_WORD [0x79]

Command support: full implementation for supported functions (note: Fans, MFR\_SPECIFIC, Unknown not supported)

Format	8 bit unsigned (bit field)							
Bit Position	15	14	13	12	11	10	9	8
Access	r	r	r	r	r	r	r	r
Function	VOUT	I/POUT	INPUT	MFR_SPEC <sup>1</sup>	#PWR_GOOD	FANS <sup>1</sup>	OTHER <sup>1</sup>	UN KNOWN <sup>1</sup>

Format	8 bit unsigned (bit field)							
Bit Position	7	6	5	4	3	2	1	0
Access	r	r	r	r	r	r	r	r
Function	BUSY <sup>1</sup>	OUTPUT_OFF	VOUT_OV_FAULT	IOUT_OC_FAULT	VIN_UV_FAULT	TEMP	CML	NONE OF ABOVE <sup>1</sup>

(1) Not supported

### STATUS\_VOUT [0x7A]

Command support: VOUT\_OV\_FAULT support, all bit reset supported

Format	8 bit unsigned (bit field)							
Bit Position	7	6	5	4	3	2	1	0
Access	r/reset(1)	r/ reset	r/ reset	r/ reset	r/ reset	r/ reset	r/ reset	r/ reset
Function	VOUT_OV_FAULT	VOUT_OV_WARN <sup>1</sup>	VOUT_UV_WARN <sup>1</sup>	VOUT_UV_FAULT <sup>1</sup>	VOUT_MAX_WARN <sup>1</sup>	TON_MAX_FAULT <sup>1</sup>	TOFF_MAX_WARN <sup>1</sup>	VOUT TRACKING ERROR <sup>1</sup>

(1) Not supported

### STATUS\_IOUT [0x7B]

Command support: IOUT\_OC\_FAULT support, all bit reset supported

Format	8 bit unsigned (bit field)							
Bit Position	7	6	5	4	3	2	1	0
Access	r/ reset(1)	r/ reset	r/ reset	r/ reset	r/ reset	r/ reset	r/ reset	r/ reset
Function	IOUT_OC_FAULT	IOUT_OC_LV_FAULT <sup>1</sup>	IOUT_OC_WARN	IOUT_UC_FAULT <sup>1</sup>	Current Share Fault <sup>1</sup>	In Power Limiting Mode <sup>1</sup>	POUT_OP_FAULT <sup>1</sup>	POUT_OP_WARN <sup>1</sup>

(1) Not supported

### STATUS\_INPUT [0x7C]

Command support: VIN\_OV\_FAULT support, all bit reset supported

Format	8 bit unsigned (bit field)							
Bit Position	7	6	5	4	3	2	1	0
Access	r/ reset(1)	r/ reset	r/ reset	r/ reset	r/ reset	r/ reset	r/ reset	r/ reset
Function	VIN_OV_FAULT	VIN_OV_WARN <sup>1</sup>	VIN_UV_WARN <sup>1</sup>	VIN_UV_FAULT	Unit Off (low input voltage)	IIN_OC_FAULT <sup>1</sup>	IIN_OC_WARN <sup>1</sup>	PIN_OP_WARN <sup>1</sup>

(1) Not supported

### STATUS\_TEMPERATURE [0x7D]

Command support: OT\_WARN, OT\_FAULT supported, all bit reset supported

Format	8 bit unsigned (bit field)							
Bit Position	7	6	5	4	3	2	1	0
Access	r/ reset(1)	r/ reset	r/ reset	r/ reset	r/ reset	r/ reset	r/ reset	r/ reset
Function	OT_FAULT	OT_WARN	UT_WARN <sup>1</sup>	UT_FAULT <sup>1</sup>	reserved	reserved	reserved	reserved

(1) Not supported



## QBDE084A0B Barracuda™ Series DC-DC Power Modules

40-60Vdc Input; 12.0Vdc,84.0A, 1000W Output

### STATUS\_CML [0x7E]

Command support: PEC\_FAULT, INVALID\_DATA, INVALID\_CMD supported, all bit reset supported

Format	8 bit unsigned (bit field)							
Bit Position	7	6	5	4	3	2	1	0
Access	r/ reset(1)	r/ reset	r/ reset	r/ reset	r/ reset	r/ reset	r/ reset	r/ reset
Function	INVALID CMD	INVALID DATA	PEC FAILED	MEMORY FAULT <sup>1</sup>	PROC FAULT <sup>1</sup>	reserved	COM FAULT (other) <sup>1</sup>	Memory/ Logic fault (other) <sup>1</sup>

(1) Not supported

### READ\_VIN [0x88]

Command support: full support

### READ\_VOUT [0x8B]

Command support: full support

### READ\_IOUT [0x8C]

Command support: full support

### READ\_TEMPERATURE\_1 [0x8D]

Command support: full support

### PMBUS\_REVISION [0x98]

Command support: full support

Format	8 bit unsigned (bit field)							
Bit Position	7	6	5	4	3	2	1	0
Access	r	r	r	r	r	r	r	r
Function	Part I Revision				Part II Revision			
Default Value	0	1	0	reserved	0	0	1	0

\*See Table below:

PMBus Revision Data Byte Contents				
Bits [7:5]	Part I Revision	Bit [4]	Bits [3:0]	Part II Revision
000	1.0	Not used	0000	1.0
001	1.1	Not used	0001	1.1
010	1.2	Not used	0010	1.2

### MFR\_DEVICE\_TYPE [0xD0]

Command support: partial support in place (Mod Name)

Format	Unsigned Binary																
Bit Pos.	7	6	5	4	3	2	1	0	7	6	5	4	3	2	1	0	
Access	r/w	r/w	r/w	r/w	r/w	r	r	r	r/w	r/w	r/w	r/w	r/w	r/w	r/w	r/w	
Function	Reserved								Module Name							WPE	Res
Default	0	0	0	0	0	0	0	0	1	0	1	0	1	0	1	0	

Byte	Bit	Description	Value	Meaning
High Byte	7:0	Reserved		
Low Byte	7:2	Module Name <sup>1</sup>	101110	Module Name
	1	WPE	0	Write Protect Enable not active.
			1	Write Protect Enable active.
	0	Reserved	0	Reserved

1. Present module designations (Non-isolated units will have a 0XXXXX format)

a. QBDE084A0B4xxx: [101110]

## QBDE084A0B Barracuda™ Series DC-DC Power Modules

40-60Vdc Input; 12.0Vdc, 84.0A, 1000W Output

### **MFR\_VOUT\_READ\_CAL\_GAIN [0xD1]**

Factory default: 0x2000

Range limits (max/min): 0x2666/0x1999

Units: N/A

Command support: support for VOUT gain calibration (factor in flash), lockout per MFR\_DEVICE\_TYPE

### **MFR\_VOUT\_READ\_CAL\_OFFSET [0xD2]**

Range limits (max/min): exp must = -12

Units: N/A

Data format: VOUT linear except with a two's complement (signed) mantissa

Command support: support for VOUT offset calibration (factor in flash), lockout per MFR\_DEVICE\_TYPE

### **MFR\_VIN\_READ\_CAL\_GAIN [0xD3]**

Factory default: 0x2000

Range limits (max/min): 0x2666/0x1999

Command support: support for VIN gain calibration (factor in flash), lockout per MFR\_DEVICE\_TYPE

### **MFR\_VIN\_READ\_CAL\_OFFSET [0xD4]**

Data format: VIN linear format

Range limits (max/min): exp must = -3

Units: N/A

Command support: support for VIN offset calibration (factor in flash), lockout per MFR\_DEVICE\_TYPE

### **MFR\_IOUT\_CAL\_GAIN [0xD6]**

Range limits (max/min): 0x2666/0x1999

Units: N/A

Command support: support for IOUT gain calibration, lockout per MFR\_DEVICE\_TYPE

### **MFR\_IOUT\_CAL\_OFFSET [0xD7]**

Range limits (max/min): exp must = -3

Units: N/A

Command support: support for IOUT offset calibration, lockout per MFR\_DEVICE\_TYPE

### **MFR\_FW\_REV [0xDB]**

Range limits (max/min): 9999/0000

Units: N/A

Command support: full read support

Format: 4 hex characters: Major revision, Minor revision, Build high, Build low (0xMj.Mn.Bh.Bl)

Example: 0x1218 indicates firmware revision 1.2.18.

## QBDE084A0B Barracuda™ Series DC-DC Power Modules

40-60Vdc Input; 12.0Vdc,84.0A, 1000W Output

### MFR\_ARA\_CONFIG [0xE0]

Command support: Full support.

Command	<b>MFR_ARA_CONFIG</b>							
Format	8 bit unsigned (bit field)							
Bit Position	7	6	5	4	3	2	1	0
Access	r	r	r	r/w	r/w	r/w	r/w	r/w
Function	Reserved			ARA	Reserved			
Default Value	0	0	0	0	0	0	0	0

Bit	Description	Value	Meaning
7:5	Reserved	000	Reserved
4	ARA	0	ARA not functional, module remains at resistor programmed address when SMBLAERT is asserted
		1	ARA functional, module responds to ARA only, when SMBLAERT is asserted
3:0	Reserved		Reserved

### MFR\_PGOOD\_POLARITY [0xE2]

Command support: full support (bit 0) as follows:

Bit 0: 0 = Negative PGOOD logic (module PGOOD asserted when pin is LO, PGOOD de-asserted when pin is HI)

1 = Positive PGOOD logic (module PGOOD de-asserted when pin is LO, PGOOD asserted when pin is HI)

Command	<b>MFR_PGOOD_POLARITY</b>							
Format	8 bit unsigned (bit field)							
Bit Position	7	6	5	4	3	2	1	0
Access	r	r	r	r	r	r	r	r/w
Function	Reserved							logic
Default Value	0	0	0	0	0	0	0	1

### MFR\_MODULE\_DATE\_LOC\_SN [0xF0]

Command support: read/write support for 12-byte block, lockout per MFR\_DEVICE\_TYPE

## QBDE084A0B Barracuda™ Series DC-DC Power Modules

40-60Vdc Input; 12.0Vdc, 84.0A, 1000W Output

### PMBus Command Quick Reference Table

PMBUS_CMD	CMD CODE	DATA BYTES	DATA FORMAT	DATA UNITS	TRANSFER TYPE*	DEFAULT VALUE
OPERATION	0x01	1	Bit field	N/A	R/W byte	0x80
ON_OFF_CONFIG	0x02	1	Bit field	N/A	R/W byte	0x1D (Neg Logic) 0x1F (Pos Logic)
CLEAR_FAULTS	0x03	0	N/A	N/A	Send byte	none
STORE_DEFAULT_ALL	0x11	0	N/A	N/A	Send byte	none
RESTORE_DEFAULT_ALL	0x12	0	N/A	N/A	Send byte	none
VOUT_MODE	0x20	1	mode + exp	N/A	Read byte	0x14
VOUT_COMMAND	0x21	2	VOUT linear	Volts	R/W word	12.000V (Std code)
VOUT_CAL_OFFSET	0x23	2	VOUT linear	Volts	R/W word	MS
VOUT_MARGIN_HIGH	0x25	2	VOUT linear	Volts	R/W word	12.000V
VOUT_MARGIN_LOW	0x26	2	VOUT linear	Volts	R/W word	11.400V
VOUT_DROOP	0x28	2	linear	mV/A	R/W word	0 (without -P) 10 (with -P)
VIN_ON	0x35	2	linear	V	R/W word	39.000V
VIN_OFF	0x36	2	linear	V	R/W word	36.500V
VOUT_OV_FAULT_LIMIT	0x40	2	VOUT linear	V	R/W word	15.000V
VOUT_OV_FAULT_RESPONSE	0x41	1	Bit field	N/A	R/W byte	0xB8
IOUT_OC_FAULT_LIMIT	0x46	2	linear	Amps	R/W word	100A
IOUT_OC_FAULT_RESPONSE	0x47	1	Bit field	N/A	R/W byte	0xF8
IOUT_OC_WARN_LIMIT	0x4A	2	linear	Amps	R/W word	90A
OT_FAULT_LIMIT	0x4F	2	linear	Deg. C	R/W word	140C
OT_FAULT_RESPONSE	0x50	1	Bit field	N/A	R/W byte	0xB8
OT_WARN_LIMIT	0x51	2	linear	Deg. C	R/W word	125C
VIN_OV_FAULT_LIMIT	0x55	2	linear	V	R/W word	65V
VIN_OV_FAULT_RESPONSE	0x56	1	Bit field	N/A	R/W byte	0xC0
POWER_GOOD_ON	0x5E	2	VOUT linear	V	R/W word	11.400V
POWER_GOOD_OFF	0x5F	2	VOUT linear	V	R/W word	9.800V
TON_DELAY	0x60	2	linear	msec	R/W word	0ms
TON_RISE	0x61	2	linear	msec	R/W word	15ms (without -P) 200ms (with -P)
STATUS_WORD	0x79	2	Bit field	N/A	Read word	N/A
STATUS_VOUT	0x7A	1	Bit field	N/A	Read byte	N/A
STATUS_IOUT	0x7B	1	Bit field	N/A	Read byte	N/A
STATUS_INPUT	0x7C	1	Bit field	N/A	Read byte	N/A
STATUS_TEMPERATURE	0x7D	1	Bit field	N/A	Read byte	N/A
STATUS_CML	0x7E	1	Bit field	N/A	Read byte	N/A
READ_VIN	0x88	2	linear	v	Read word	N/A
READ_VOUT	0x8B	2	VOUT linear	v	Read word	N/A
READ_IOUT	0x8C	2	linear	Amps	Read word	N/A
READ_TEMP1	0x8D	2	linear	Deg. C	Read word	N/A
PMBUS_REVISION	0x98	1	Bit Field	n/a	Read byte	1.2
MFR_DEVICE_TYPE	0xD0	2	Custom	N/A	R/W word	0x00AA
MFR_VOUT_READ_CAL_GAIN	0xD1	2	16 bit unsigned	N/A	R/W word	0x2000
MFR_VOUT_READ_CAL_OFFSET	0xD2	2	mod VOUT linear	N/A	R/W word	MS
MFR_VIN_READ_CAL_GAIN	0xD3	2	16 bit unsigned	N/A	R/W word	MS
MFR_VIN_READ_CAL_OFFSET	0xD4	2	linear	N/A	R/W word	MS
MFR_IOUT_CAL_GAIN	0xD6	2	16 bit unsigned	N/A	R/W word	MS
MFR_IOUT_CAL_OFFSET	0xD7	2	linear	N/A	R/W word	MS
MFR_FW_REV	0xDB	2	16 bit unsigned	N/A	Read byte	0x1101
MFR_ARA_CONFIG	0xE0	1	Bit field	N/A	R/W byte	0x00
MFR_PGOOD_POLARITY	0xE2	1	Bit field	N/A	R/W byte	0x01
MFR_MOD_DATE_LOC_SN	0xF0	12	8 bit char	N/A	R/W block	YYLLWW123456

MS=Module specific

\*Some Write commands are ignored until Write Protection is disabled using the MFR\_DEVICE\_TYPE (0xD0) command. These are identified by "lockout per MFR\_DEVICE\_TYPE" In the preceding detailed command descriptions.

# QBDE084A0B Barracuda™ Series DC-DC Power Modules

40-60Vdc Input; 12.0Vdc, 84.0A, 1000W Output

## Mechanical Outline for QBDE084A0B41-HZ (Base plate) Through-hole Module

Dimensions are in millimeters and [inches].

Tolerances: x.x mm ± 0.5 mm [x.xx in. ± 0.02 in.] (Unless otherwise indicated)

x.xx mm ± 0.25 mm [x.xxx in ± 0.010 in.]

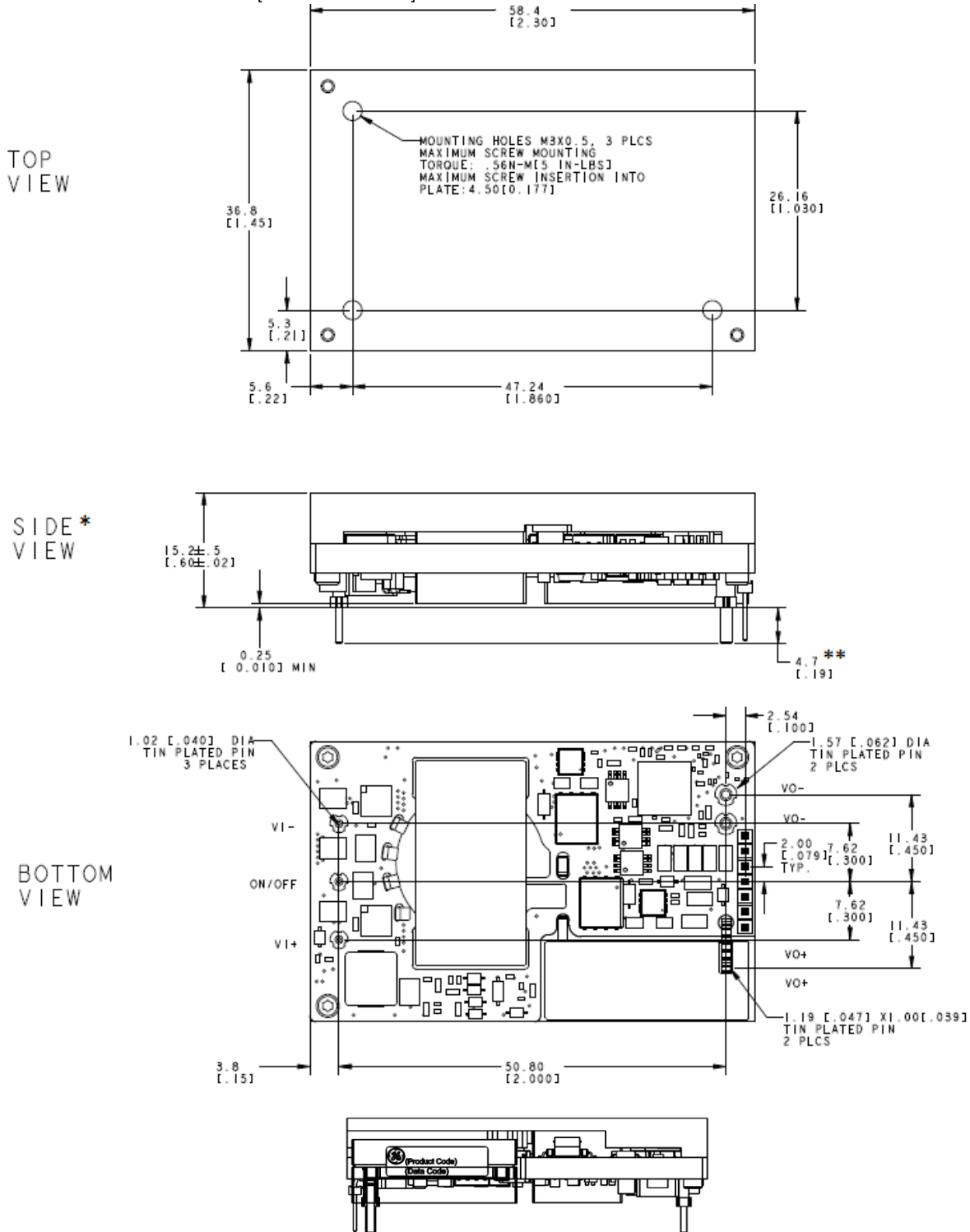

\*Side label includes "GE," product designation, and date code

\*\* Standard pin tail length. Optional pin tail lengths shown in Table 2, Device Options.

# QBDE084A0B Barracuda™ Series DC-DC Power Modules

40-60Vdc Input; 12.0Vdc, 84.0A, 1000W Output

## Recommended Pad Layouts

Dimensions are in millimeters and (inches).

Tolerances: x.x mm ± 0.5 mm [x.xx in. ± 0.02 in.] (unless otherwise indicated)  
 x.xx mm ± 0.25 mm [x.xxx in ± 0.010 in.]

Pin Number	Pin Name
1	VIN(+)
2	ON/OFF
3	VIN(-)
4	VOUT(-)
5	VOUT(-)
7	VOUT(+)
8	VOUT(+)
9	POWER GOOD
10	SIG GND
11	DATA
12	SMBALERT
13	CLK
14	ADDR1
15	ADDR0

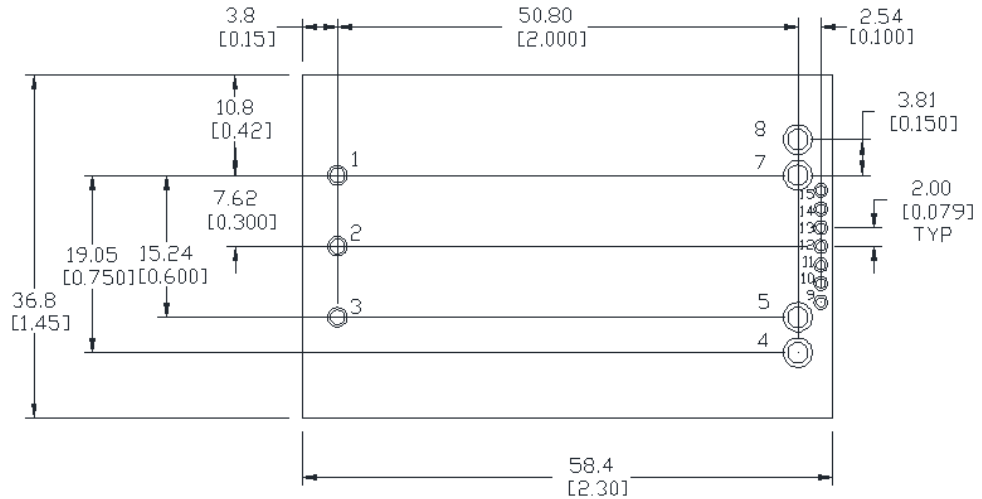

Hole and Pad diameter recommendations:

Pin Number	Hole Dia mm [in]	Pad Dia mm [in]
1, 2, 3	1.6 [.063]	2.1 [.083]
9, 10, 11, 12, 13, 14, 15	1.0 [.039]	1.5 [.059]
4,5,7,8	2.2 [.087]	3.2 [.126]

## Packaging Details

All versions of the QBDE084A0B are supplied as standard in the plastic trays shown in Figure 27.

### Tray Specification

Material	PET (1mm)
Max surface resistivity	10 <sup>9</sup> -10 <sup>11</sup> Ω/PET
Color	Clear
Capacity	12 power modules
Min order quantity	24 pcs (1 box of 2 full trays + 1 empty top tray)

Each tray contains a total of 12 power modules. The trays are self-stacking and each shipping box for the QBDE084A0B module contains 2 full trays plus one empty hold-down tray giving a total number of 24 power modules.

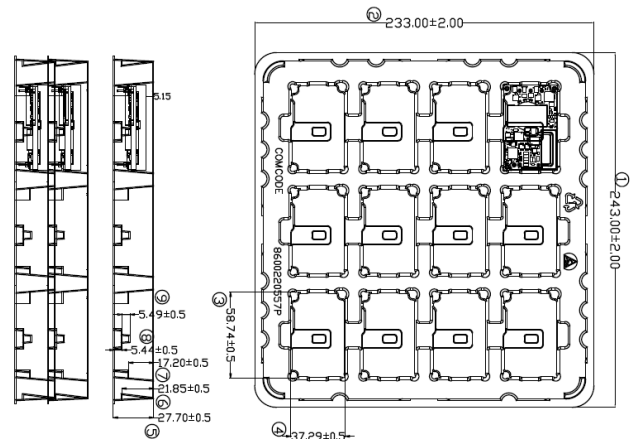

Base Plate Module Tray

Figure 27. QBDE084A0B Packaging Tray

## QBDE084A0B Barracuda™ Series DC-DC Power Modules

40-60Vdc Input; 12.0Vdc,84.0A, 1000W Output

### Ordering Information

Please contact your GE Sales Representative for pricing, availability and optional features.

**Table 1 Device Codes.**

Product Codes	Input Voltage	Output Voltage	Output Current	Efficiency	Connector Type	MSL Ra-ting	Comcodes
QBDE084A0B641-PHZ	50V (40–60Vdc)	12V	84A	96.5%	Through hole	2a	1600189257A

**Table 2. Device Options.**

	Characteristic	Character and Position	Definition
Ratings	Form Factor	Q	Q = Quarter Brick
	Family Designator	BD	BD = BARRACUDA Digital Series with PMBus Interface
	Input Voltage	E	E = 40V- 60V
	Output Power	067A0	067A0 =67.0 Rated Output Current
	Output Voltage	B	B =12.0V nominal
Options	Pin Length	8 6	Omit = Default Pin Length shown in Mechanical Outline (4.70 mm) 8 = Pin Length: 2.79 mm ± 0.25mm, (0.110 in. ± 0.010 in.) 6 = Pin Length: 3.68 mm ± 0.25mm, (0.145 in. ± 0.010 in.)
	Action following Protective Shutdown	4	Omit = Latching Mode 4 = Auto-restart following shutdown (Overcurrent/Overvoltage)
	On/Off Logic	1	Omit = Positive Logic 1 = Negative Logic
	Modification	XY	XY= Modification Code, Omitted for Standard Code
	Load Share	P	P= Forced Droop Output for use in parallel applications
	Heat Plate	H	H = Heat plate, for use with a heat sink or cold wall
	RoHS	Z	Z = RoHS 6/6 Compliant, Lead free



## Contact Us

For more information, call us at

USA/Canada:

+1 877 546 3243, or +1 972 244 9288

Asia-Pacific:

+86-21-53899666

Europe, Middle-East and Africa:

+49.89.878067-280

[Go.ABB/Industrial](http://Go.ABB/Industrial)

ABB IDCP reserves the right to make changes to the product(s) or information contained herein without notice, and no liability is assumed as a result of their use or application. No rights under any patent accompany the sale of any such product(s) or information.

# Mouser Electronics

Authorized Distributor

Click to View Pricing, Inventory, Delivery & Lifecycle Information:

[OmniOn Power:](#)

[QBDE084A0B641-PHZ](#)