



MODEL: SJ2-3574A-SMT-TR | **DESCRIPTION:** AUDIO JACK

FEATURES

- narrow footprint
- right angle
- reflow solder compatible
- surface mount



SPECIFICATIONS

parameter	conditions/description	min	typ	max	units
rated input voltage			12		Vdc
rated input current				1	A
contact resistance				50	mΩ
insulation resistance	at 500 Vdc	100			MΩ
voltage withstand	for 1 minute			500	Vac
insertion/withdrawal force		0.3		3	kg
operating temperature		-40		85	°C
life			5,000		cycles
flammability rating	UL94V-0				
RoHS	yes				

SOLDERABILITY

parameter	conditions/description	min	typ	max	units
hand soldering	for 3~4 seconds	340	350	360	°C
reel storage	-5~35°C, 25~80% humidity reel opened: use within 1 month reel unopened: use within 6 months				
reflow soldering	see reflow profile	260	265	270	°C

Note: 1. Same Sky recommends usage of the product within 2 hours after T&R is opened. After 6 hours, Same Sky recommends drying the parts prior to use.

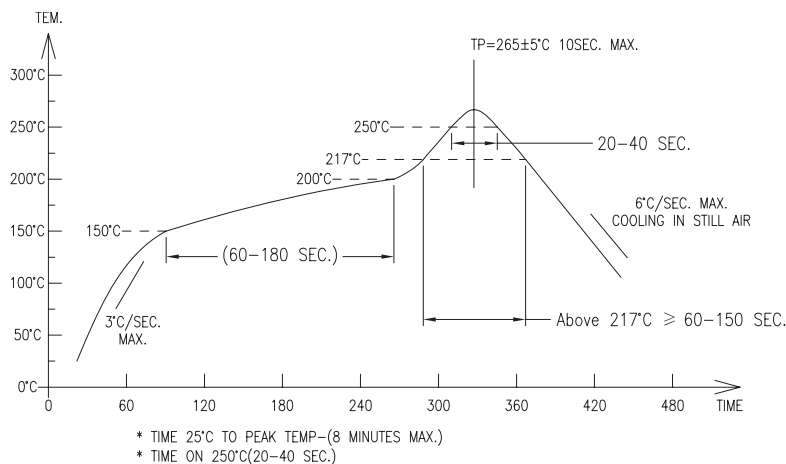

MECHANICAL DRAWING

units: mm
 tolerance:
 X, ±0.50 mm
 X.X ±0.20 mm
 X.XX ±0.10 mm
 PCB: ±0.05 mm
 unless otherwise specified

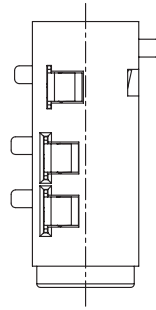
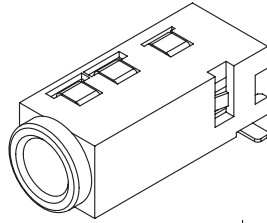

DESCRIPTION	MATERIAL	PLATING/COLOR
terminal 1	phosphor copper t=0.20 mm	silver
terminal 2	phosphor copper t=0.20 mm	silver
terminal 3	phosphor copper t=0.20 mm	silver
terminal 4	phosphor copper t=0.20 mm	silver
housing	PA10T [UL94V-0]	black

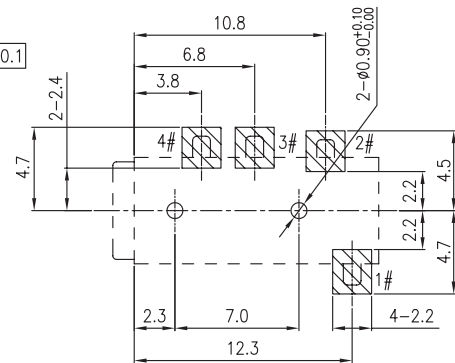
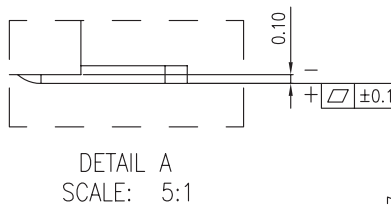
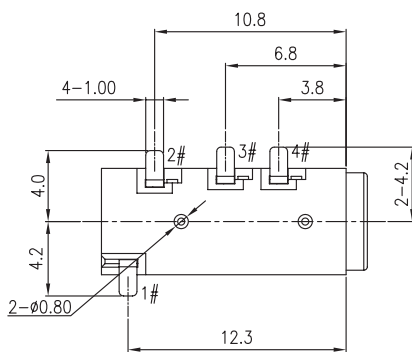
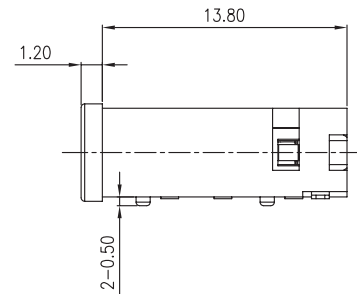
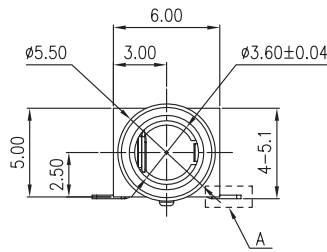
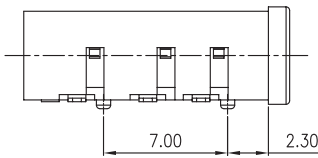

Recommended PCB Layout
Top View

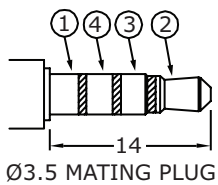

Model No.	SJ2-3574A-SMT-TR
Schematic	
PIN	
1	sleeve
2	tip
3	ring 1
4	ring 2

PACKAGING

units: mm

Reel Size: $\varnothing 330$ mm
 Reel QTY: 1,000 pcs per reel

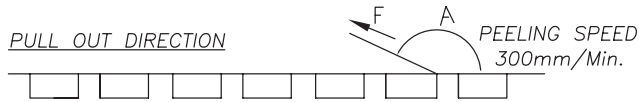
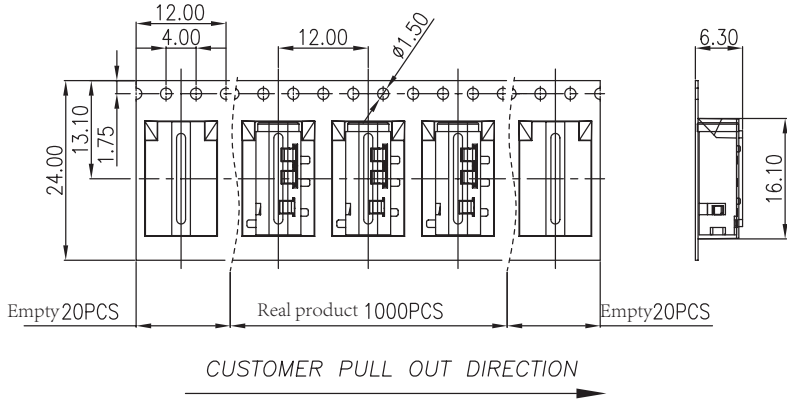

COVER TYPE PEELING FORCE:

A	160°-180°
F	10gf-130gf

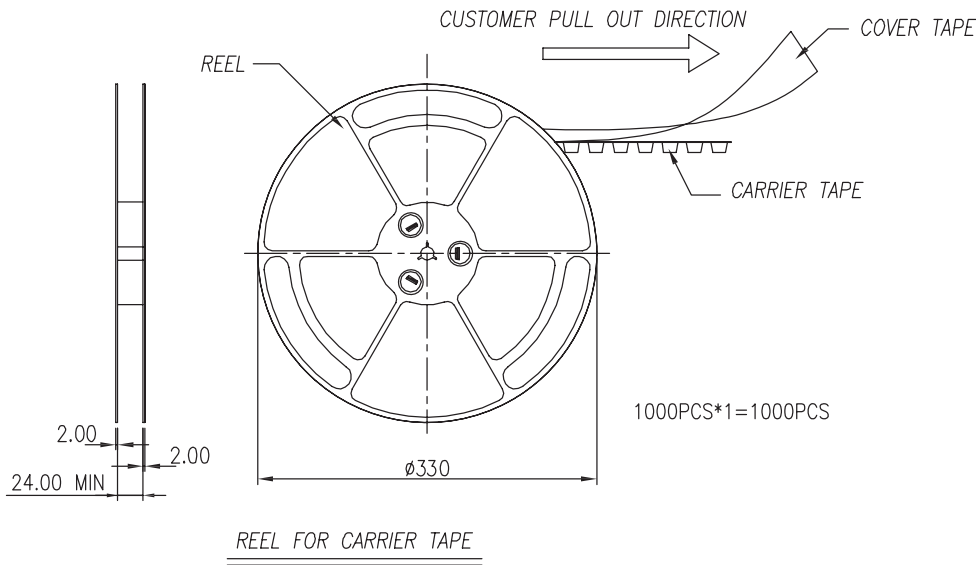
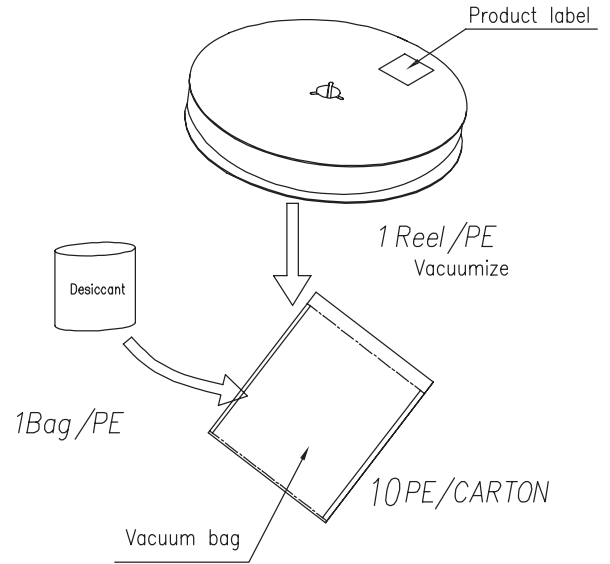

REVISION HISTORY

rev.	description	date
1.0	initial release	12/19/2016
1.01	added storage and drying conditions	06/09/2017
1.02	brand update	10/10/2019
1.03	discontinued models SJ2-3573A2-SMT-TR & SJ2-3573A-SMT-TR; logo, datasheet style update	08/18/2022
1.04	product reengineered for improved manufacturability and production yield, see PCN for details	08/02/2023
1.05	CUI Devices rebranded to Same Sky	09/12/2024

The revision history provided is for informational purposes only and is believed to be accurate.



Same Sky offers a one (1) year limited warranty. Complete warranty information is listed on our website.

Same Sky reserves the right to make changes to the product at any time without notice. Information provided by Same Sky is believed to be accurate and reliable. However, no responsibility is assumed by Same Sky for its use, nor for any infringements of patents or other rights of third parties which may result from its use.

Same Sky products are not authorized or warranted for use as critical components in equipment that requires an extremely high level of reliability. A critical component is any component of a life support device or system whose failure to perform can be reasonably expected to cause the failure of the life support device or system, or to affect its safety or effectiveness.

[sameskydevices.com](https://www.sameskydevices.com)

Mouser Electronics

Authorized Distributor

Click to View Pricing, Inventory, Delivery & Lifecycle Information:

[Same Sky:](#)

[SJ2-3574A-SMT-TR](#)