

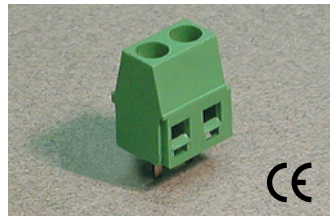

Pin Spacing: 5.08mm
 Orientation: Vertical
 Clamp Type: Screw Cage
 Design: Modular



MVS-15xx-5.08

ELECTRICAL

	Current	Voltage	Wire Range
	10A ^①	300V	30-16AWG
	16A	250V	1.5mm ² Stranded 2.5mm ² Solid

INSTALLATION DATA

Screw Size	M3	PCB Hole Size	1.5mm
Torque	0.5Nm (4.5 lbf-in.)	Stripping Lgth.	6.9mm

MATERIAL

Body	Polyamide	Screw	Galvanized Steel
Flammability Class	UL94V-0	Terminal	Tin-Plated Brass
Temperature Limit	105°C UL 125°C IEC	Clamp	Nickel Brass
Color	Green		

No. Poles	Cat. #	Length (mm)	Std. Pk.
2	MVS-152-5.08	10.0	100
3	MVS-153-5.08	15.0	100
4	MVS-154-5.08	20.0	50
5	MVS-155-5.08	25.0	50
6	MVS-156-5.08	30.0	50
7	MVS-157-5.08	35.0	50
8	MVS-158-5.08	40.0	50
9	MVS-159-5.08	45.0	50
10	MVS-1510-5.08	50.0	50
11	MVS-1511-5.08	55.0	50
12	MVS-1512-5.08	60.0	50

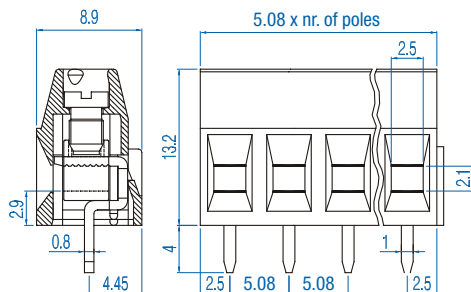

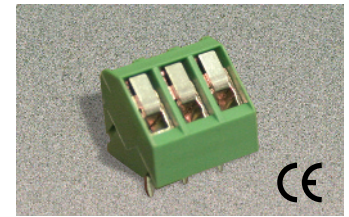

^①13.5A Factory Wiring - UL

Pin Spacing: 5.08mm
 Orientation: 35°
 Clamp Type: Screw Cage
 Design: Modular



MIP-25xx-5.08-IQ

ELECTRICAL

	Current	Voltage	Wire Range
	24A ^①	300V	30-14 AWG
	24A	250V	2.5mm ²

INSTALLATION DATA

Screw Size	M3	PCB Hole Size	1.5mm
Torque	0.5Nm (4.5 lbf-in.)	Stripping Lgth.	6.9mm

MATERIAL

Body	Polyamide	Screw	Galvanized Steel
Flammability Class	UL94V-0	Terminal	Tin-Plated Brass
Temperature Limit	105°C UL 125°C IEC	Clamp	Nickel Brass
Color	Green		

No. Poles	Cat. #	Length (mm)	Std. Pk.
2	MIP252-5.08-IQ	10.2	100
3	MIP253-5.08-IQ	15.2	100
4	MIP254-5.08-IQ	20.3	50
5	MIP255-5.08-IQ	25.4	50
6	MIP256-5.08-IQ	30.5	50
7	MIP257-5.08-IQ	35.6	50
8	MIP258-5.08-IQ	40.6	50
9	MIP259-5.08-IQ	45.7	50
10	MIP2510-5.08-IQ	50.8	50
11	MIP2511-5.08-IQ	55.9	50
12	MIP2512-5.08-IQ	61.0	50
13	MIP2513-5.08-IQ	66.0	20
14	MIP2514-5.08-IQ	71.1	20
15	MIP2515-5.08-IQ	76.2	20
16	MIP2516-5.08-IQ	81.3	20
17	MIP2517-5.08-IQ	86.4	20
18	MIP2518-5.08-IQ	91.4	20
19	MIP2519-5.08-IQ	96.5	20
20	MIP2520-5.08-IQ	101.6	20
21	MIP2521-5.08-IQ	106.7	20
22	MIP2522-5.08-IQ	111.8	20
23	MIP2523-5.08-IQ	116.8	20
24	MIP2524-5.08-IQ	121.9	20

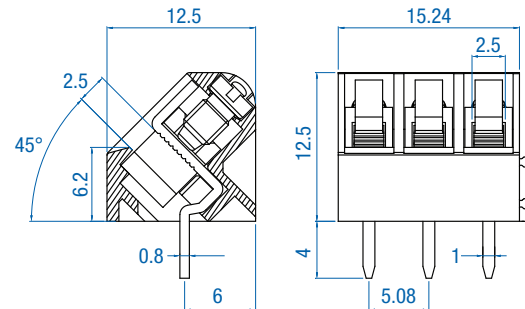

^①17.5A Factory Wiring - UL

Mouser Electronics

Authorized Distributor

Click to View Pricing, Inventory, Delivery & Lifecycle Information:

[Altech:](#)

[MIP258-5.08-IQ](#) [MIP254-5.08-IQ](#) [MIP252-5.08-IQ](#) [MIP253-5.08-IQ](#)