

Altech Corp.®



NEW DESIGN

H = 35 mm

H = 75 mm

WIRE DUCT

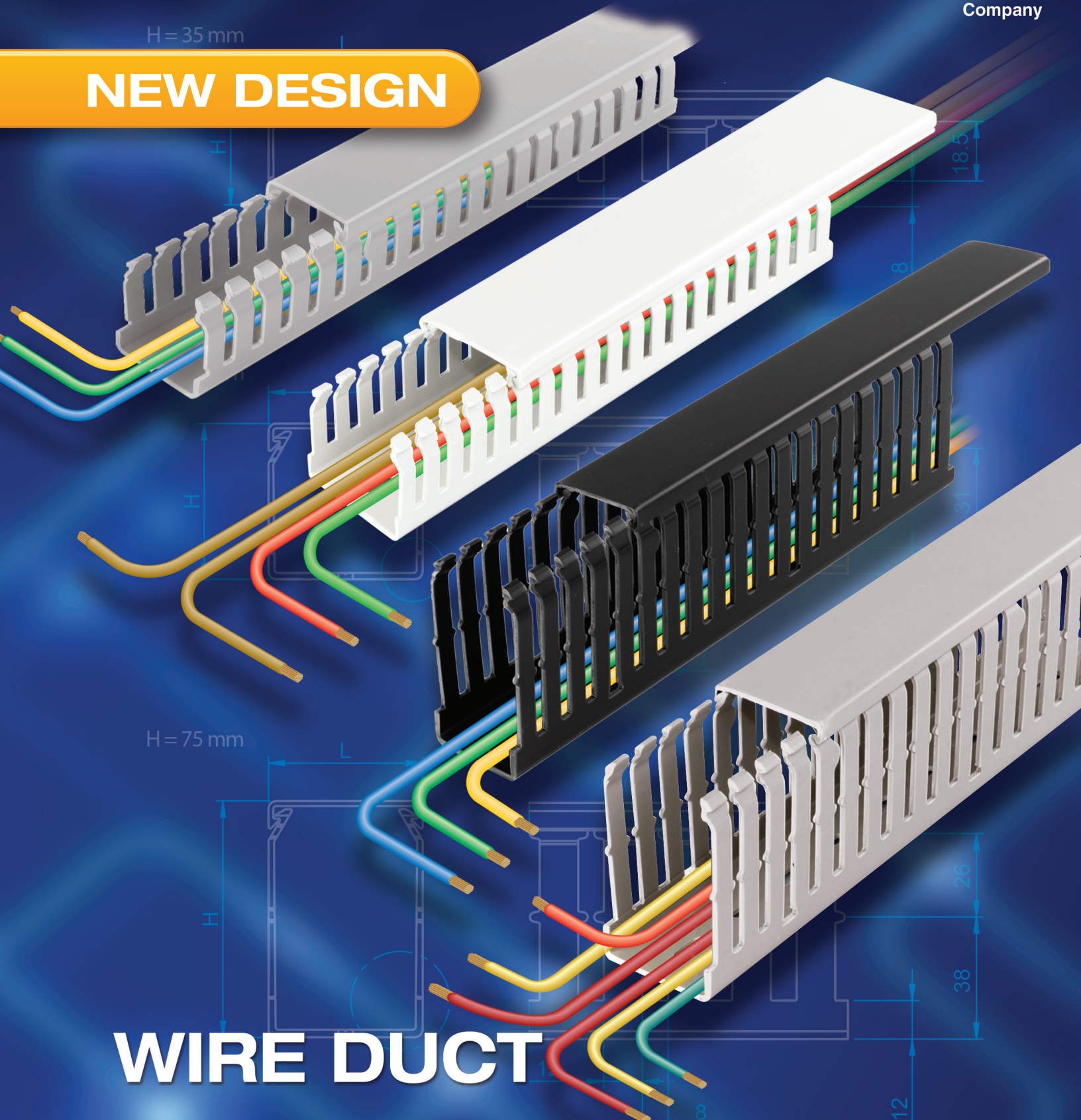

Product Features

The Panel building market has very specific needs. This unique cable management system developed specifically for use within cabinets and control panels. Select Standard, Thin, Closed Slot and Unslotted depending on the application. Available in a number of sizes and colors, manufactured in standard PVC material.

BREAK-OUT

Fingers can be removed easily without the use of cutting tools

Additional break point at base to remove sections of the complete sidewall

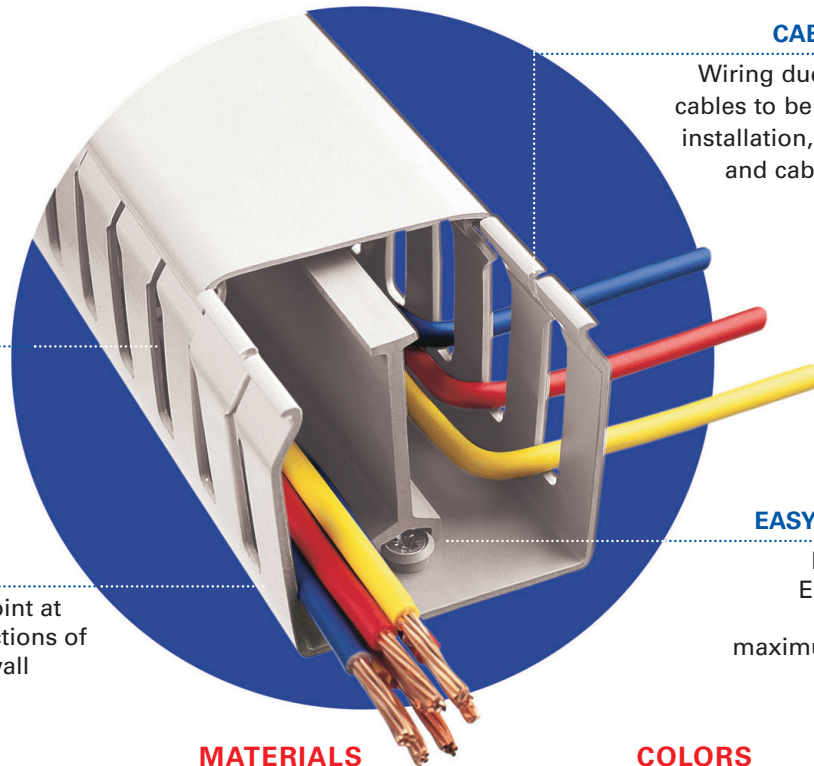

CABLE RETENTION

Wiring duct design allows cables to be retained during installation, making routing and cable termination a simple process

EASY INSTALLATION

Base slots are to EN50085-2-3/ DIN 43659 providing maximum flexibility for easy installation

SIZE RANGE

- Wide range of sizes to cater to a broad spectrum of requirements
- New narrower profiles to reduce panel footprint

MATERIALS

- The standard range is manufactured using self extinguishing PVC

COLORS

- Gray, white and black are standard

Standard Wiring Duct

PVC provides a lightweight self extinguishing wiring duct with excellent rigidity and performance characteristics.

Standard Slot

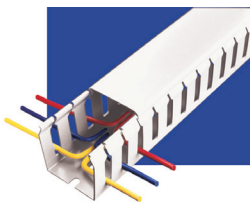

- Wide fingers giving additional cable support
- Terminated wires can be re-routed easily
- 0.79" slot pitch
- 0.31" slot width
- 18 sizes, available in gray, white or black

Unslotted

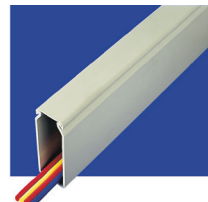

- Ideal where no break-outs are required or side wall access is infrequent
- Complete cable protection
- Available on request

Thin Slot

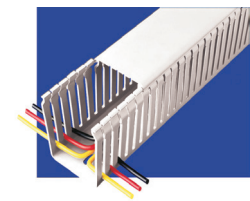

- Ideal for use with slimmer terminal blocks where more access is required
- Improves appearance of panels with cables out in best position
- 0.49" slot pitch
- 0.20" slot width
- 16 sizes, available in gray, white or black

Closed Slot

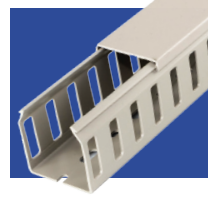

- Ideal where slots are needed but wire retention in slot needs to be maintained when lid is off
- Available on request

All part numbers include lid and base.

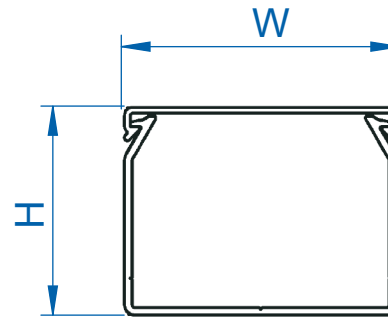
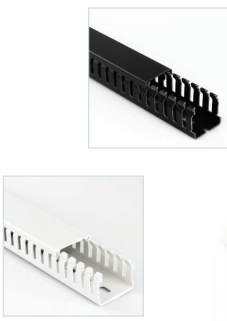

Standard Slot

Supplied with lid

nominal size w x h inches	external dimensions		part no. selection			standard pack	
	width inches (mm)	height inches (mm)	gray RAL 7030	white RAL 9010	black RAL 9005	no. of lengths 6 1/2' each	total feet
1" x 1 1/2"	0.91 (23)	1.40 (35.5)	B25X35S	B25X35S/W	B25X35S/B	12	78
1" x 2"	0.91 (23)	1.89 (48)	B25X50S	B25X50S/W	B25X50S/B	12	78
1" x 3"	0.98 (25)	2.87 (73)	B25X75S	B25X75S/W	B25X75S/B	8	52
1 1/2" x 1 1/2"	1.40 (35.5)	1.40 (35.5)	B35X35S	B35X35S/W	B35X35S/B	12	78
1 1/2" x 2"	1.40 (35.5)	1.89 (48)	B35X50S	B35X50S/W	B35X50S/B	8	52
1 1/2" x 3"	1.40 (35.5)	2.87 (73)	B35X75S	B35X75S/W	B35X75S/B	8	52
2" x 1 1/2"	1.89 (48)	1.40 (35.5)	B50X35S	B50X35S/W	B50X35S/B	8	52
2" x 2"	1.89 (48)	1.89 (48)	B50X50S	B50X50S/W	B50X50S/B	8	52
2" x 3"	1.89 (48)	2.87 (73)	B50X75S	B50X75S/W	B50X75S/B	8	52
2" x 4"	1.89 (48)	3.94 (100)	B50X100S	B50X100S/W	B50X100S/B	4	26
3" x 2"	2.87 (73)	1.89 (48)	B75X50S	B75X50S/W	B75X50S/B	8	52
3" x 3"	2.87 (73)	2.87 (73)	B75X75S	B75X75S/W	B75X75S/B	8	52
3" x 4"	2.87 (73)	3.94 (100)	B75X100S	B75X100S/W	B75X100S/B	4	26
4" x 2"	3.86 (98)	1.89 (48)	B100X50S	B100X50S/W	B100X50S/B	4	26
4" x 3"	3.86 (98)	2.87 (73)	B100X75S	B100X75S/W	B100X75S/B	4	26
4" x 4"	3.86 (98)	3.94 (100)	B100X100S	B100X100S/W	B100X100S/B	4	26
5" x 3"	4.84 (123)	2.87 (73)	B125X75S	B125X75S/W	B125X75S/B	4	26
6" x 4"	5.91 (150)	3.94 (100)	B150X100S	B150X100S/W	B150X100S/B	4	26

MATERIAL

self extinguishing PVC

STANDARD COLORS

gray, white, black

SERVICE TEMPERATURE

+5° F to +149° F (-15° C to +65° C)

FLAMMABILITY

UL94 V-O rated material

STANDARDS

base slots to DIN 43659
/EN 50085-2-3

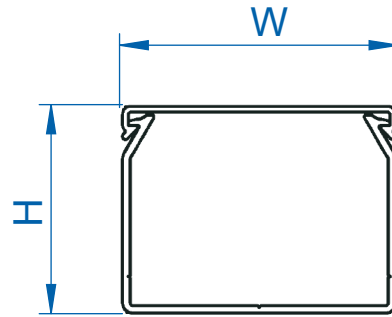

Thin Slot

Supplied with lid

nominal size w x h inches	external dimensions		part no. selection			standard pack	
	width inches (mm)	height inches (mm)	gray RAL 7030	white RAL 9010	black RAL 9005	no. of lengths 6 1/2' each	total feet
1" x 1 1/2"	0.91 (23)	1.40 (35.5)	B25X35T	B25X35T/W	B25X35T/B	12	78
1" x 2"	0.91 (23)	1.89 (48)	B25X50T	B25X50T/W	B25X50T/B	12	78
1" x 3"	0.98 (25)	2.87 (73)	B25X75T	B25X75T/W	B25X75T/B	8	52
1 1/2" x 1 1/2"	1.40 (35.5)	1.40 (35.5)	B35X35T	B35X35T/W	B35X35T/B	12	78
1 1/2" x 2"	1.40 (35.5)	1.89 (48)	B35X50T	B35X50T/W	B35X50T/B	8	52
1 1/2" x 3"	1.40 (35.5)	2.87 (73)	B35X75T	B35X75T/W	B35X75T/B	8	52
2" x 1 1/2"	1.89 (48)	1.40 (35.5)	B50X35T	B50X35T/W	B50X35T/B	8	52
2" x 2"	1.89 (48)	1.89 (48)	B50X50T	B50X50T/W	B50X50T/B	8	52
2" x 3"	1.89 (48)	2.87 (73)	B50X75T	B50X75T/W	B50X75T/B	8	52
2" x 4"	1.89 (48)	3.94 (100)	B50X100T	B50X100T/W	B50X100T/B	4	26
3" x 2"	2.87 (73)	1.89 (48)	B75X50T	B75X50T/W	B75X50T/B	8	52
3" x 3"	2.87 (73)	2.87 (73)	B75X75T	B75X75T/W	B75X75T/B	8	52
3" x 4"	2.87 (73)	3.94 (100)	B75X100T	B75X100T/W	B75X100T/B	4	26
4" x 2"	3.86 (98)	1.89 (48)	B100X50T	B100X50T/W	B100X50T/B	4	26
4" x 3"	3.86 (98)	2.87 (73)	B100X75T	B100X75T/W	B100X75T/B	4	26
4" x 4"	3.86 (98)	3.94 (100)	B100X100T	B100X100T/W	B100X100T/B	4	26

MATERIAL

self extinguishing PVC

STANDARD COLORS

gray, white, black

SERVICE TEMPERATURE

+5° F to +149° F (-15° C to +65° C)

FLAMMABILITY

UL94 V-O rated material

STANDARDS

base slots to EN50085-2-3

Standard Slot Dimensions

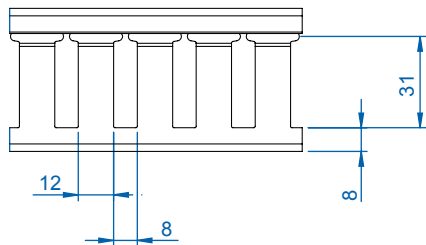
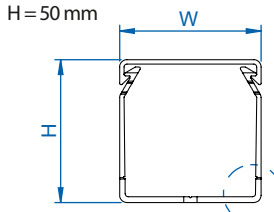
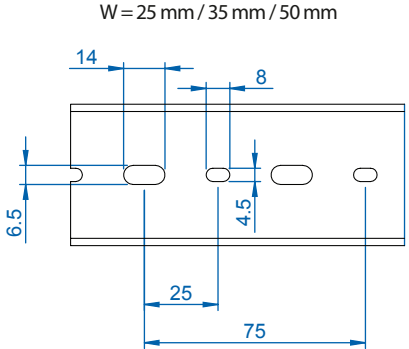
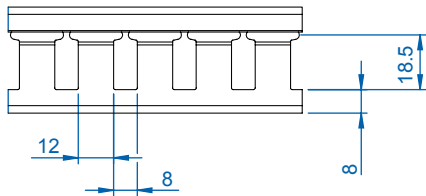
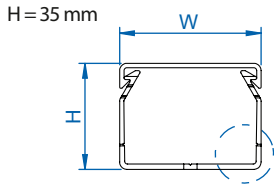

W = 75 mm / 100 mm / 125 mm / 150 mm

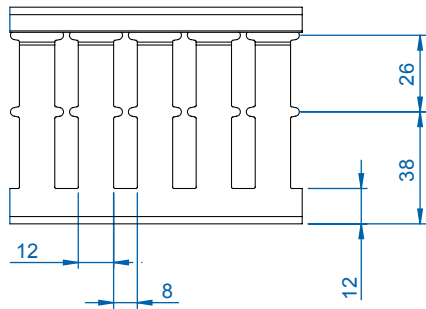
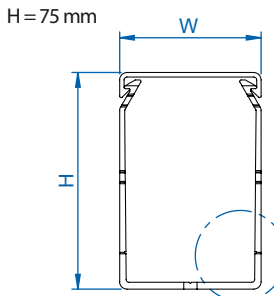
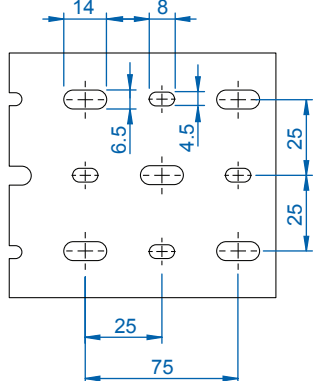

3x4, 4x4 and 6x4" duct does not have middle mounting row of slots

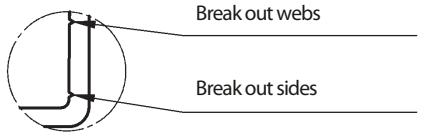
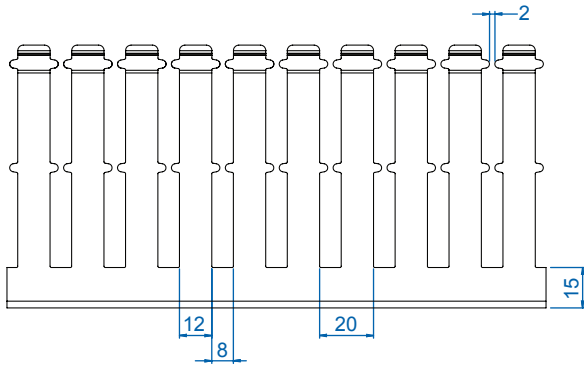
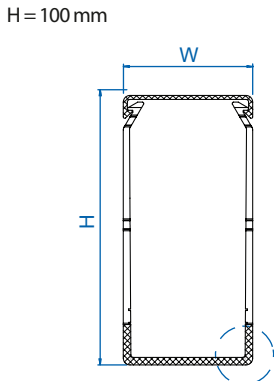

Thin Slot Dimensions

H = 25 mm

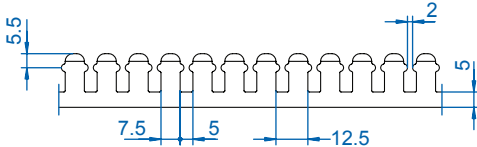
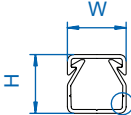

W = 25, 35 and 50 mm

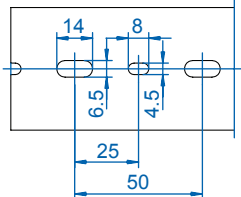

H = 35 mm
H = 50 mm

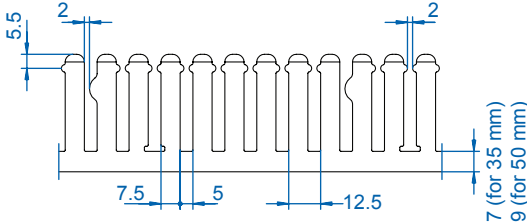
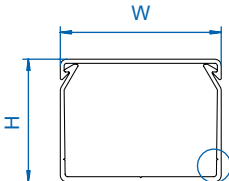

H = 75 mm

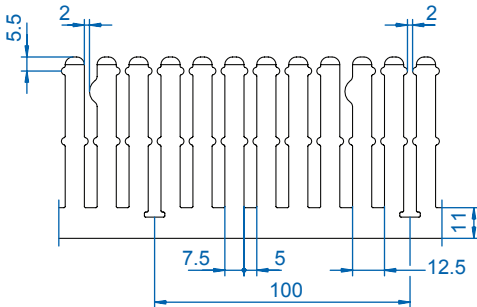
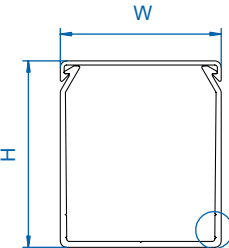

W = 75 mm / 100 mm

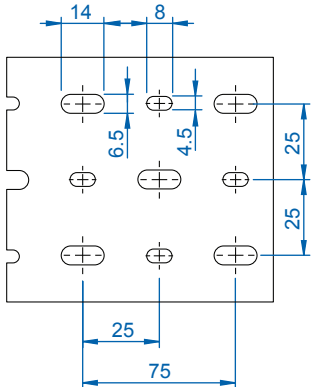

3x4, 4x4 and 6x4" duct does not have middle mounting row of slots

H = 100 mm

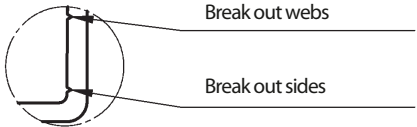
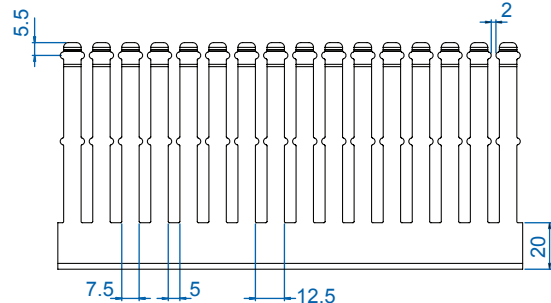
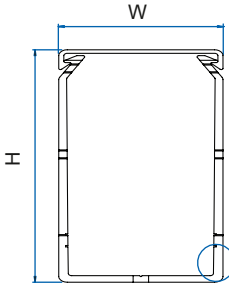

Mouser Electronics

Authorized Distributor

Click to View Pricing, Inventory, Delivery & Lifecycle Information:

Altech:

[B100x100US-R](#) [B100x60US/W-R](#) [B130x80US-R](#) [B25x40US/W-R](#) [B60x25US/W-R](#) [B60x40US-R](#) [B80x80US-R](#)
[B60x40US/W-R](#) [B60x100T/W-R](#) [B60x100T-R](#) [B60x25S/W-R](#) [B60x25S-R](#) [B60x40S/W-R](#) [B60x40S-R](#) [B25x100S/BU-](#)
[R](#) [B40x40US-W/R](#) [B40x60S/BL-R](#) [B60x60S/BL-R](#) [B60x80T/BL-R](#) [B80x80T/BL-R](#) [B60x100S/W-R](#) [B60x100S-R](#)
[B25x80T/BL-R](#) [B40x40S/BL-R](#) [B40x40T/BL-R](#) [B80x80S-R](#) [B80x80T/W-R](#) [B25x80S/BL-R](#) [B25x100T/W-R](#)
[B25x100T-R](#) [B40x60S/BU-R](#) [B25x60S/BL-R](#) [B25x60T/BL-R](#) [B25x80S/BU-R](#) [B100x80T/W-R](#) [B100x80T-R](#)
[B130x80S/W-R](#) [B130x80S-R](#) [B25x100S/W-R](#) [B25x100S-R](#) [B100x60S/W-R](#) [B100x60S-R](#) [B100x60T/W-R](#)
[B100x60T-R](#) [B100x80S/W-R](#) [B100x80S-R](#) [B100x100S/W-R](#) [B100x100S-R](#) [B100x100T/W-R](#) [B100x100T-R](#)
[B100x130S/W-R](#) [B100x130S-R](#) [B40x80T/W-R](#) [B40x80T-R](#) [B80x80T-R](#) [B25x40T/BL-R](#) [B60x80S/BL-R](#)
[B100x100S/BU-R](#) [B40x60S-R](#) [B40x60T/W-R](#) [B40x60T-R](#) [B40x80S/BL-R](#) [B40x80S/W-R](#) [B40x80S-R](#) [B40x100T-R](#)
[B40x40S/W-R](#) [B40x40S-R](#) [B40x40T/W-R](#) [B40x40T-R](#) [B40x60S/W-R](#) [B25x80T/W-R](#) [B25x80T-R](#) [B40x100S/BU-R](#)
[B40x100S/W-R](#) [B40x100S-R](#) [B40x100T/W-R](#) [B25x60S/W-R](#) [B25x60S-R](#) [B25x60T/W-R](#) [B25x60T-R](#) [B25x80S/W-R](#)
[B25x80S-R](#) [B80x80S/W-R](#) [B25x40S/W-R](#) [B25x40S-R](#) [B25x40T/W-R](#) [B25x40T-R](#) [B25x60S/BU-R](#) [B80x40T/W-R](#)
[B80x40T-R](#) [B80x60S/W-R](#) [B80x60S-R](#) [B80x60T/W-R](#) [B80x60T-R](#) [B80x100S/W-R](#) [B80x100S-R](#) [B80x100T/W-R](#)
[B80x100T-R](#) [B80x40S/W-R](#) [B80x40S-R](#)