

Model 5972 & 5972A 24 Lead SSOP Test Clip 0.65 mm Lead Pitch

These new test clips provide the user with an easy means to connect instrumentation to the fine pitch plastic SSOP chip leads.

The 5972A version offers greater security with spring loaded locking fingers.

- Interfaces with high density SSOP surface mount chip leads.
- Spring loaded locking fingers insures positive retention on the chip in either vertical or horizontal position.
- Pin number 1 indicator on the side of the clip.
- Gold plated, beryllium copper contacts assure solid and secure connections to chip leads.
- Gold plated phosphor-bronze connector pins provide noise free, low resistance connections.

Pomona's SSOP test clips are perfect for system design, field service testing, and failure analysis.

Other clips are also available in many sizes to fit many of the most popular SSOP chips now in use.

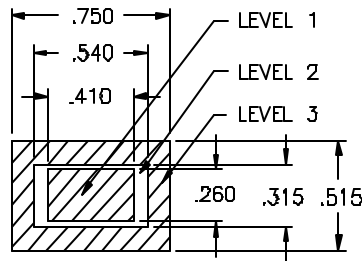
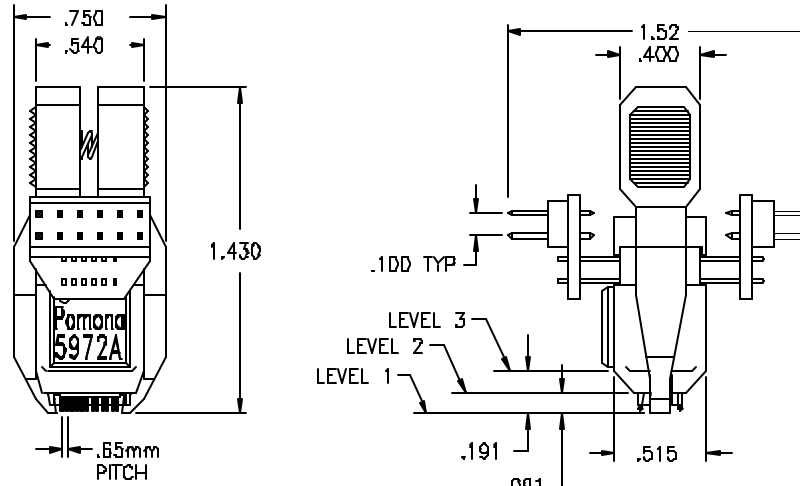

REQUIRED FOOTPRINT

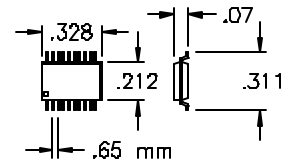

24 PIN SSOP CHIP

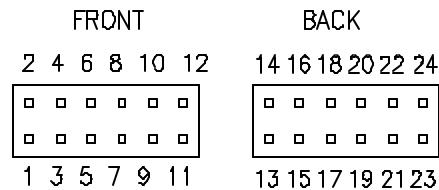

24 LEAD SSOP PIN LAYOUT

All dimensions are in inches. Tolerances (except noted): .xx = ±.02" (.51 mm), .xxx = ±.005" (.127 mm). All specifications are to the latest revisions. Specifications are subject to change without notice. Registered trademarks are the property of their respective companies. Made in USA

These new test clips provide the user with an easy means to connect instrumentation to the fine pitch plastic SSOP chip leads.

- Interfaces with high density SSOP surface mount chip leads.
- Holding feature insures positive retention on the chip in either horizontal or vertical position.
- Pin number 1 indicator on the side of the clip.
- Gold plated, beryllium copper contacts assure solid and secure connections to chip leads.
- Gold plated phosphor-bronze connector pins provide noise free, low resistance connections.

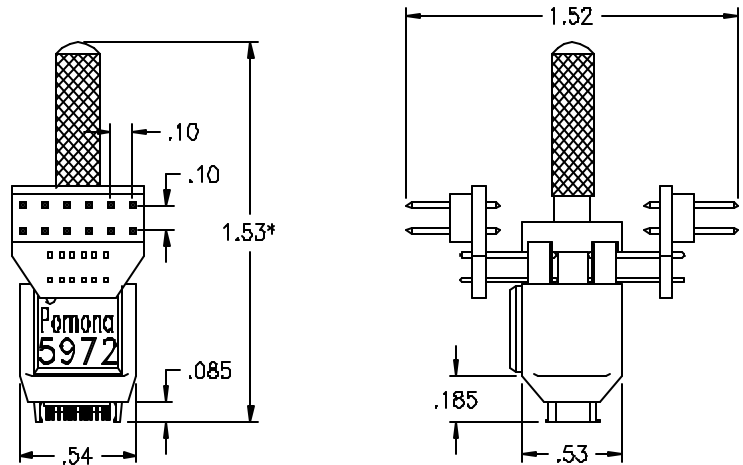

*HANDLE IS NOT REMOVABLE

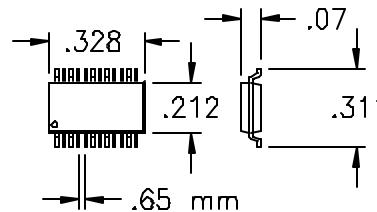

24 PIN SSOP CHIP

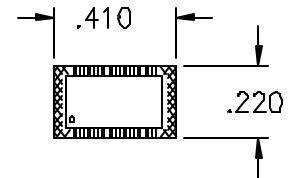

REQUIRED BOARD SPACE

Pomona's SSOP test clips are perfect for system design, field service testing, and failure analysis.

Other clips are also available in many sizes to fit many of the most popular SSOP chips now in use.

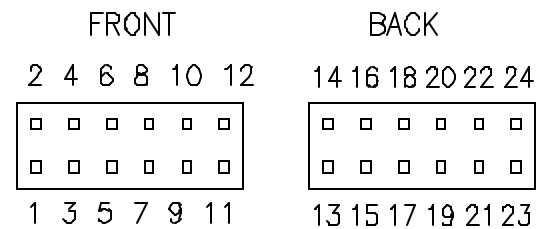

24 LEAD SSOP PIN LAYOUT

All dimensions are in inches. Tolerances (except noted): .xx = ±.02" (.51 mm), .xxx = ±.005" (.127 mm). All specifications are to the latest revisions. Specifications are subject to change without notice. Registered trademarks are the property of their respective companies. Made in USA

Mouser Electronics

Authorized Distributor

Click to View Pricing, Inventory, Delivery & Lifecycle Information:

[Pomona:](#)

[5972](#)