

FLUKE®

70/73

Series III Multimeter

Instruction Sheet

Read First: Safety Information



To ensure that the meter is used safely, follow these instructions:

- Never use the meter if the meter or test leads look damaged.
- Be sure the test leads and rotary switch are in the correct position for the desired measurement.
- Never measure resistance in a circuit when power is applied.
- Never touch the probes to a voltage source when the test leads are plugged into the 10 A or 300 mA input jack.
- To avoid damage or injury, never use the meter on circuits that exceed 4800 volt-amps.
- Never apply more than the rated voltage between any input jack and earth ground.
- Be careful when working with voltages above 60 V dc or 30 V ac rms. Such voltages pose a shock hazard.
- Keep your fingers behind the finger guards on the test probes when making measurements.

Warning

To avoid false readings, which could lead to possible electric shock or personal injury, replace the battery as soon as the battery indicator () appears.

Symbols

-  Read First: Safety Information
-  Manual Range or Automatic Touch Hold® mode
-  Double Insulation
- CAT II Overvoltage Installation Category per IEC 1010-1. Typical CAT II locations include main wall outlets, local appliances, and portable equipment.

Input Jacks

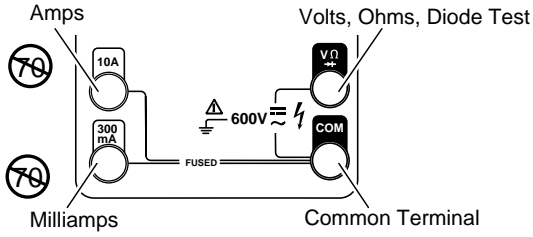

hr2f.eps

See Specifications for overload protection.

Pushbutton

Use the pushbutton to either select a fixed range or put the meter in the Automatic Touch Hold® mode.

Autorange

The meter defaults to autorange when first turned on.

Manual Range

Manual ranging is available in V ac, V dc, ohms, A ac, and A dc.

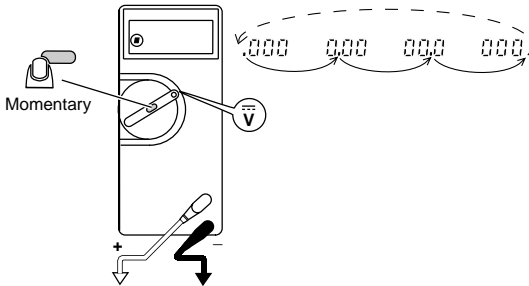

hr14f.eps

To return to autorange, press for 1 second or turn the rotary switch.

Automatic Touch Hold® Mode

⚠ Warning

To avoid electric shock, do not use the Touch Hold® to determine if a circuit with high voltage is dead. The Touch Hold® mode will not capture unstable or noisy readings.

The Touch Hold® mode automatically captures and displays stable readings. Press  for 2 seconds while turning the meter on.

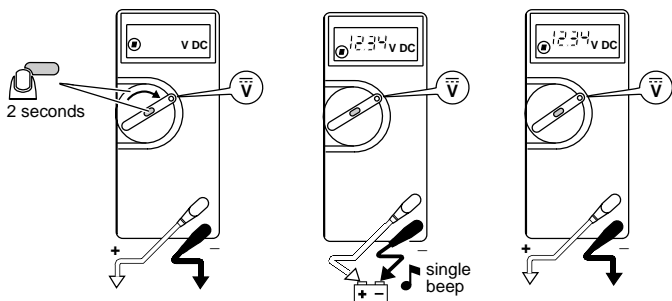

When the meter captures a new input, it beeps and a new reading is displayed. To manually force a new measurement to be held, press .

Note

Stray voltages can produce a new reading.

To exit the Touch Hold® mode, turn the meter off.

Bar Graph

The bar graph shows readings relative to the full scale value of a displayed measurement range and indicates polarity.



Standby

If the meter is on but is inactive for an hour (20 minutes in diode test), the screen goes blank and displays selected bar graph segments. To resume operation, turn the rotary switch or press .

AC and DC Voltage (\tilde{V} $\bar{\bar{V}}$ $m\bar{\bar{V}}$)

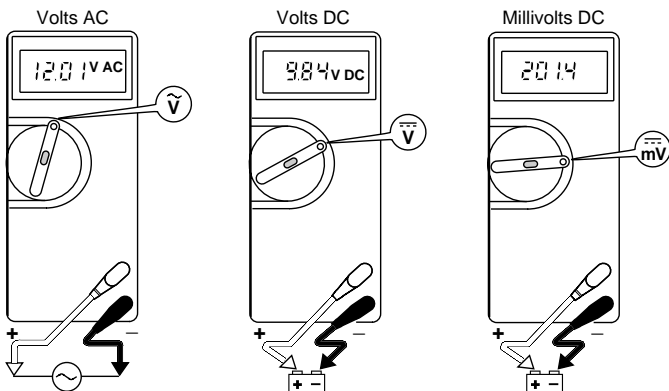

hr4f.eps

Resistance (Ω)

Turn off the power and discharge all capacitors. An external voltage across a component will give invalid resistance readings.

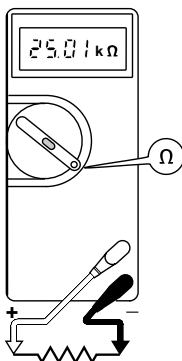

hr6f.eps

Diode Test (→→)

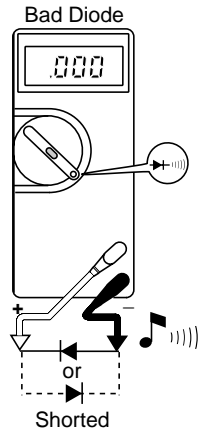
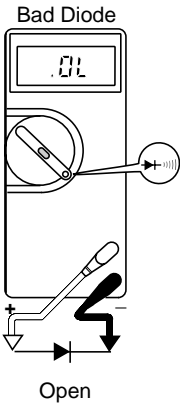
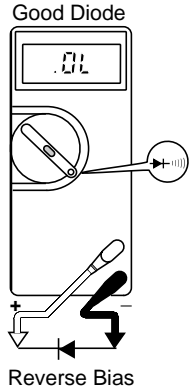
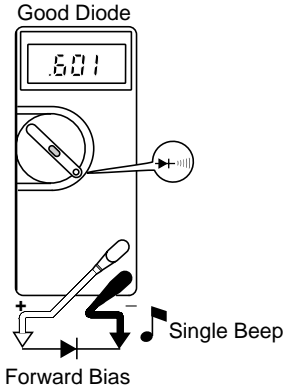

Continuity Test (|||)

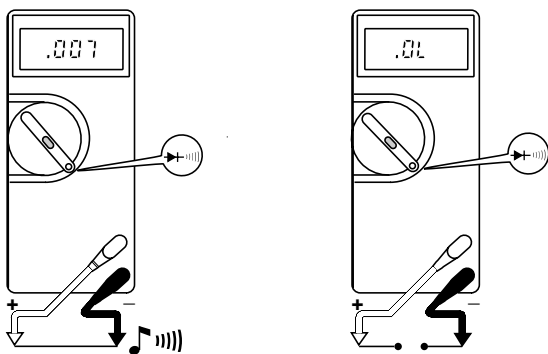

hr5f.eps

If continuity exists (resistance $< 210 \Omega$), the beeper sounds continuously. The meter beeps twice if it is in the Touch Hold® mode.

Current ($\tilde{\text{A}}$ $\bar{\text{A}}$)

Δ Warning

To avoid injury, do not attempt a current measurement if the open circuit voltage is above the rated voltage of the meter.

To avoid blowing an input fuse, use the 10 A jack until you are sure that the current is less than 300 mA.

Turn off power to the circuit. Break the circuit. (For circuits of more than 10 amps, use a current clamp.) Put the meter in series with the circuit as shown and turn power on.

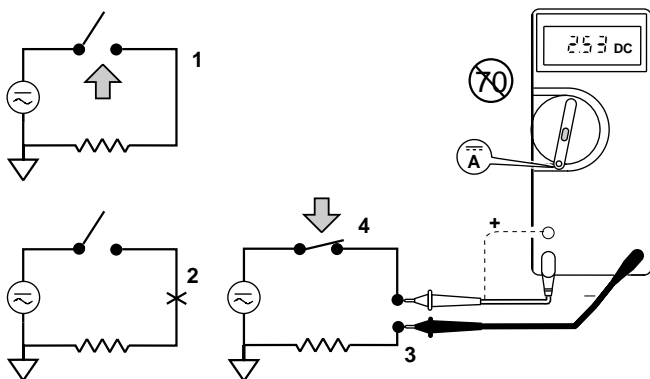

hr8f.eps

Holster

The snap-on holster absorbs shocks and protects the meter and comes with a Flex-Stand™. To protect the front of the meter, put the meter face down in the holster.

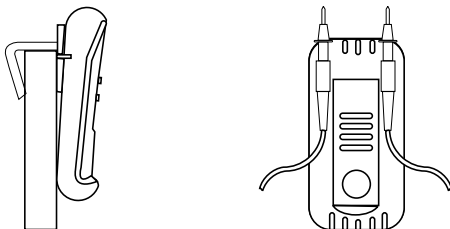

hr15f.eps

Maintenance

⚠ Warning

To avoid electric shock, remove the test leads before opening the case, and close the case before using the meter. To prevent fire and possible arc-flash, use fuses with ratings shown on the back of the meter.

Caution

To avoid damaging meter components, lift up the end of the battery as shown. To avoid contamination or static damage, do not touch the circuit board without proper static protection.

Internal Fuse Test

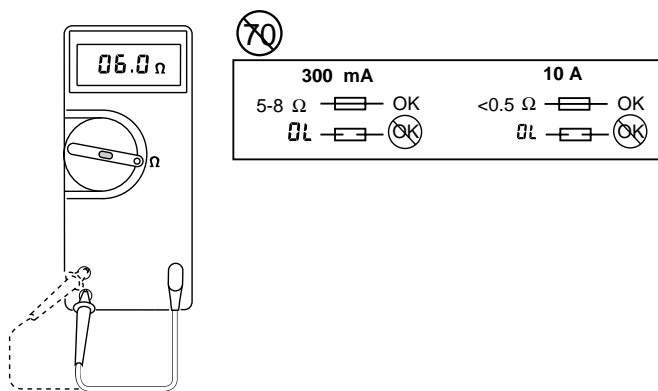

hr10f.eps

Battery and Fuse Replacement

Note

Before opening the case, make sure the test leads are removed and the rotary switch is turned to OFF.

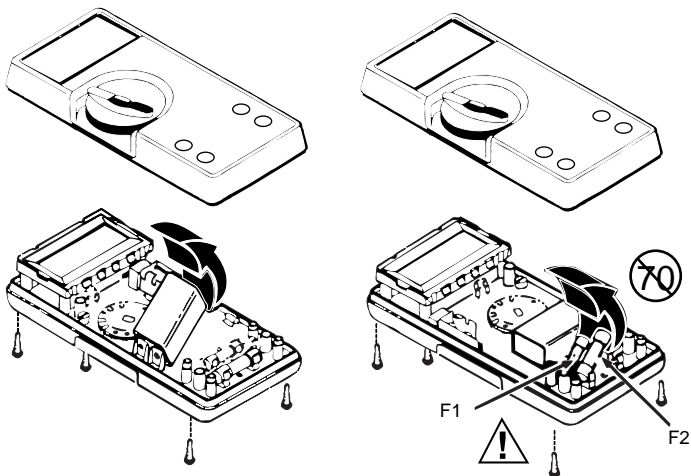

hr11f.eps

Cleaning

To clean the meter, use a damp cloth and mild detergent; do not use abrasives or solvents on the meter.

Service and Parts

For service information in the U.S.A. and Canada, call 1-800-44-FLUKE (1-800-443-5853), in Europe, 31 40 267 8200, from other countries, 1-425-356-5500.

Item	Description	Fluke PN	Quan.
BT1	Battery, 9 V, NEDA 1604/IEC 6F22, or NEDA 1604A/IEC 6LR61	696534 614487	1
F1*	Fuse, F630 mA, 250 V, Min Interrupt Rating 1500 A, IEC 127-1	740670	1
F2*	Fuse, F11 A, 1000 VAC/DC, Min Interrupt Rating 17 kA	943118	1

*** For safety, use exact replacement**

Specifications

Accuracy is specified for a period of one year after calibration, at 18°C to 28°C (64°F to 82°F) with relative humidity to 90%. AC conversions are ac-coupled, average responding, and calibrated to the RMS value of a sine wave input.

Accuracy specifications are given as:

$$\pm([\% \text{ of reading}] + [\text{number of least significant digits}])$$

Maximum Voltage Between any Terminal and Earth Ground	600 V
Display	Digital: 3,200 counts, updates 2.5/sec Analog: 31 segments, updates 25/sec
Response Time of Digital Display	V ac < 2 s V dc < 1 s Ω < 1 s to 320 k Ω , < 2s to 3.2 M Ω , < 10 s to 32 M Ω
Operating Temperature	0°C to 50°C
Storage Temperature	-40°C to 60°C
Temperature Coefficient	0.1 x (specified accuracy)/°C (<18°C or >28°C)

Electromagnetic Compatibility
in RF field of 3 V/m on all
functions except MΩ

Total accuracy = Specified accuracy
plus +2.0% of range for all functions
except:

320.0 mV range: total accuracy =
specified accuracy + 1.0% of range

320.0Ω range: total accuracy =
specified accuracy + 8% of range

Relative Humidity
except 32 MΩ Range:

0% to 90% (0°C to 35°C)
0% to 70% (35°C to 50°C)
0% to 80% (0°C to 35°C)
0% to 70% (35°C to 50°C)

32 MΩ Range only:

Altitude

Operating: 2000 meters
Storage: 12,000 meters

Battery Type

9 V, NEDA 1604 or 6F22 or 006P,
or NEDA 1604A or 6LR61

Battery Life

2000 hrs typical with alkaline
1600 hrs typical with carbon zinc

Continuity Beeper

4096 Hz

Shock, Vibration

per MIL-T-PRF 28800F Class III,
Sinusoidal, Non Operating

Size (H x W x L)

2.8 cm x 7.5 cm x 16.6 cm
(1.12 in x 2.95 in x 6.55 in)

Weight

340 g (12.0 oz)

Safety

600 V CAT II per ANSI/ISA S82.01-
1994, EN 61010-1: 1993, CSA C22.2
No 1010.1-92, UL 3111-1.

EMC Regulations

EN 61326-1: 1997

Certifications/Listings



Function	Range	Accuracy
\overline{V}	3.200 V, 32.00 V, 320.0 V 600 V	$\pm(0.3\%+1)$ $\pm(0.4\%+1)$
$m\overline{V}$	320.0 mV	$\pm(0.3\%+1)$
\tilde{V} (45 to 500 Hz, 3.2V range. Other ranges 45 to 1 kHz)	3.200 V, 32.00 V, 320.0 V, 600 V	$\pm(2\%+2)$ $\pm(2\%+2)$
Ω	320.0 Ω 3200 Ω , 32.00 k Ω , 320.0 k Ω , 3.200 M Ω 32.00 M Ω	$\pm(0.5\%+2)$ $\pm(0.5\%+1)$ $\pm(0.5\%+1)$ $\pm(2\%+1)$
$\rightarrow \rightarrow \rightarrow \rightarrow \rightarrow$	2.0 V	$\pm(1\%$ typical)

Function	Range	Accuracy	Typical Burden Voltage
\tilde{A} (45 Hz to 1 kHz) (73 only)	32.00 mA, 320.0 mA 10.00 A *	$\pm(2.5\%+2)$ $\pm(2.5\%+2)$	6 mV/mA 50 mV/A
\overline{A} (73 only)	32.00 mA, 320.0 mA 10.00 A *	$\pm(1.5\%+2)$ $\pm(1.5\%+2)$	6 mV/mA 50 mV/A
* 10 A continuous, 20 A for 30 seconds maximum.			

Overload protection for all functions and ranges: 600 V.

Function	Input Impedance (Nominal)		
\bar{V} , $m\bar{V}$, \tilde{V}	>10 M Ω , <50 pF		
	Common Mode Rejection Ratio (1 kΩ Unbalanced)	Normal Mode Rejection	
\bar{V} , $m\bar{V}$	>120 dB at dc, 50 Hz, or 60 Hz	>60 dB at 50 Hz or 60 Hz	
\tilde{V}	>60 dB dc to 60 Hz		
	Open Circuit Test Voltage	Full Scale Voltage	
		To 3.2 M Ω	32 M Ω
Ω	<3.1 V dc <2.8 V dc (typical)	<440 mV dc <420 mV dc (typical)	<1.4 V dc <1.3 V dc (typical)
$\rightarrow \leftarrow \parallel$)	<3.1 V dc	2.0 V dc	
	Typical Short Circuit Current		
Ω	400 μ A		
$\rightarrow \leftarrow \parallel$)	500 μ A		
$\rightarrow \leftarrow$	V_F	Typical Test Current	
	0.0 V	0.5 mA	
	0.6 V	0.4 mA	
	1.2 V	0.3 mA	
	2.0 V	0.1 mA	

Mouser Electronics

Authorized Distributor

Click to View Pricing, Inventory, Delivery & Lifecycle Information:

[Fluke:](#)

[740670](#)