

General-purpose type switch applicable to a wide range of electronic devices



Detector

Slide

Push

Rotary

Power

Dual-in-line
Package Type



Typical Specifications

Items		Specifications
Rating (max.)/(min.) (Resistive load)		0.25A 30V DC / 50μA 3V DC
Contact resistance (Initial / After operating life)		20mΩ max. / 60mΩ max.
Rotational torque	Shorting	80±30mN·m
	Non-shorting	70±30mN·m
Operating life	Without load	10,000 cycles
	With load	10,000 cycles (0.25A 30V DC)

Product Line

Poles	Positions	Changeover angle	Changeover timing	Actuator configuration	Actuator length (mm)	Minimum order unit (pcs.)		Product No.
						Japan	Export	
1	12 Endless	30±3°	Shorting	Round shaft with groove	15	60	240	SRRM1C6200
					20			SRRM1C5400
2	5 6		Shorting	Round shaft with groove	15			SRRM1C7800
					20			SRRM254700
3	4	Shorting	Flat	20	SRRM262400			
					SRRM264300			
4	3		Round shaft with groove	18-tooth serration	20	SRRM342800		
						SRRM433700		

Notes

- ※1 Non-shorting type requires external wiring of common terminals.
- All the axis are die casting shafts.

Packing Specifications

Tray

Number of packages (pcs.)		Export package measurements (mm)
1 case /Japan	1 case /export packing	
60	240	400×270×270

Dimensions

Unit:mm

Style

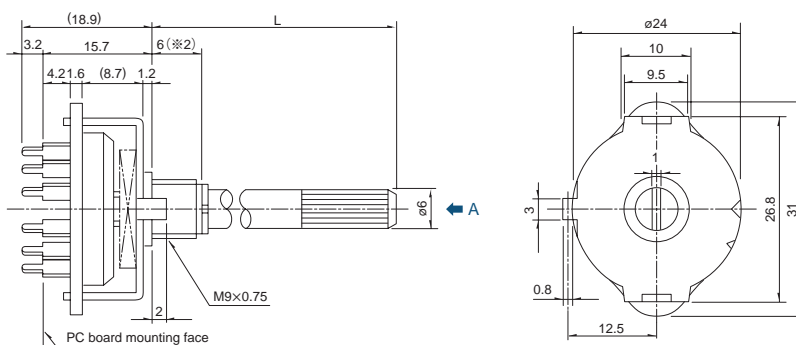

Note

※2 Round-shaft with groove (shaft length 20mm) type are 8mm length.

Refer to P.144 for shaft configurations.
Refer to P.145 for soldering conditions.

Terminal Configuration

Unit:mm

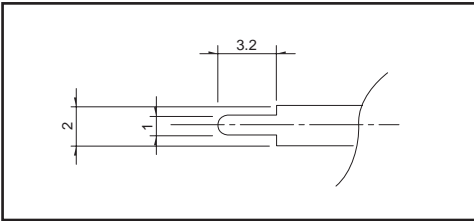

Standard Circuit Diagram

Shorting Circuit Diagram

Unit:mm

	1-pole, 12-position	2-pole, 5-position	2-pole, 6-position	3-pole, 4-position	4-pole, 3-position
Circuit diagram					
PC board mounting hole dimensions (Viewed from the direction A)					

Non Shorting Circuit Diagram

Unit:mm

	Circuit diagram	PC board mounting hole dimensions (Viewed from the direction A)
1-pole, 12-position		

Attached Parts

Unit:mm

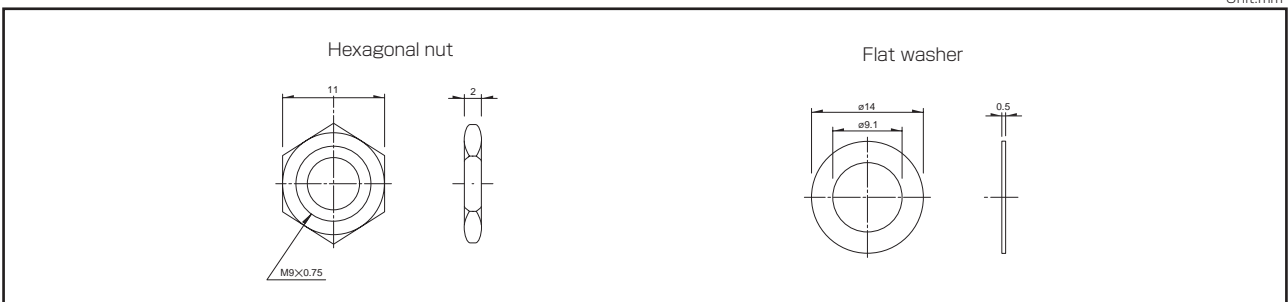

Notes

1. The ☒ mark in the above table indicate a Lug position with the shaft turned fully counterclockwise when viewed from direction A of the diagrams.
2. Note that the location of C terminal differs depending on the number of positions.
3. External wiring is required if specified in the above diagrams.

Detector

Slide

Push

Rotary

Power

Dual-in-line
Package Type

18-tooth Serration Shaft

The shaft shows the position in which it is turned fully counterclockwise.

Die Casting Shaft

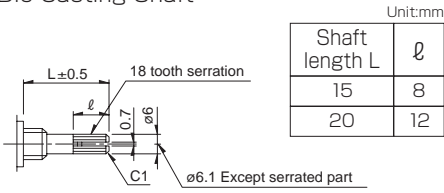

Details About Serration

- (1) The mold dimensions of standard serration and the dimensions of test jigs are as shown in the figure at left.
- (2) Position of the serration bottom
When the shaft is turned fully counterclockwise, the position of the serration bottom is on the AA line.
- (3) Slitting angle
The slitting angle (position) is not specified.

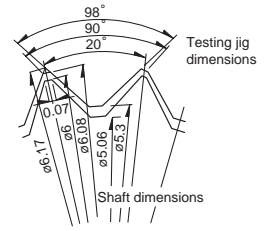

Round Shaft with Groove

The shaft shows the position in which it is turned fully counterclockwise.

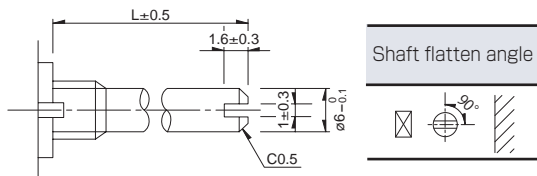

Flat Shaft

The shaft shows the position in which it is turned fully counterclockwise.

Die Casting Shaft

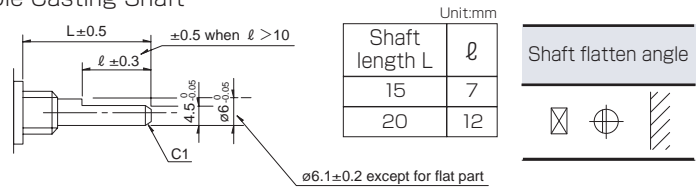











Note

Please be aware that shaft flatten angle is based on (anti-rotation lug)

Rotary Switches

List of Varieties

Series	SRBD	SRBQ		SRBM		SRBV	SRRM		
		Insertion	Reflow type	Rotary	Pulse				
Photo									
Angle of throw	36°	40±3°		30±3°	18±3°	30±3°			
Number of poles	1		1, 2		1	1, 2, 3, 4			
Rotational torque	13±5mN·m	6±3mN·m 13±5mN·m		40±20mN·m 15±7mN·m		30±15mN·m	80±30mN·m (Shorting) 70±30mN·m (Non shorting)		
Dimensions (mm)	W	10		10		16.2	—		
	D	11.4		12.5		18.5			
	H	12.4		11		7.5			
Operating temperature range	-25°C to +85°C	-10°C to +60°C		-30°C to +85°C		-10°C to +85°C	-10°C to +60°C		
Automotive use	—	—		—		—	—		
Life cycle									
Rating (max.)/(min.) (Resistive load)	1mA 5V DC 50µA 3V DC	0.1A 16V DC 50µA 3V DC				0.3A 16V DC 50µA 3V DC	0.25A 30V DC 50µA 3V DC		
Durability	Operating life without load	10,000 cycles 250mΩ max.	10,000 cycles 100mΩ max.		30,000 cycles 100mΩ max.	10,000 cycles 100mΩ max.	10,000 cycles 40mΩ max.		
	Operating life with load Load: as rating	10,000 cycles 250mΩ max.	10,000 cycles 100mΩ max.	10,000 cycles 150mΩ max.		10,000 cycles 60mΩ max.			
Electrical performance	Initial contact resistance	200mΩ max.	50mΩ max.				20mΩ max.		
	Insulation resistance	100MΩ min. 100V DC					100MΩ min. 500V DC		
	Voltage proof	100V AC for 1minute					500V AC for 1minute		
Mechanical performance	Terminal strength	3N for 1minute	5N for 1minute				10N for 1minute		
	Actuator strength	Operating direction	—	—	0.5N·m	—	0.6N·m	1N·m	
		Pulling direction	50N	20N	100N				
	Wobble of actuator	Load at the tip of shaft SRRM, SRBM, SRBQ, SRBV: 1N							
The below table shows for SRRM, SRBM			The below table shows for SRBQ		The below table shows for SRBV				
		Measuring position from mounting surface	Shaft wobble (max. value)	Applicable mounting dimension	Distance from mounting surface to the tip of shaft	Shaft wobble (max. value)	Measuring position from mounting surface	Shaft wobble (max. value)	Applicable mounting dimension
		10	0.17	15	below 5	0.5	10	0.2	15
		15	0.25	20	above 5 and below 10	0.9	15	0.3	20
		20	0.35	25	above 10 and below 15	1.2	20	0.4	25
		25	0.42	30					
		30	0.5	above 35					
Unit:mm									
Environmental performance	Cold	-40°C 500h	-20°C 96h	-40°C 96h		-20°C 96h			
	Dry heat	85°C 500h	85°C 96h						
	Damp heat	60°C, 90 to 95%RH 500h	40°C, 90 to 95%RH 96h						
Page	133	135	137	140	142				

Rotary Switches Soldering Conditions	145
Rotary Switches Cautions	146

Rotary Switches / Soldering Conditions

Example of Reflow Soldering Condition

1. Heating method: Double heating method with infrared heater.
2. Temperature measurement: Thermocouple $\phi 0.1$ to 0.2 CA (K) or CC (T) at soldering portion (copper foil surface).
A heat resisting tape should be used for fixed measurement.
3. Temperature profile

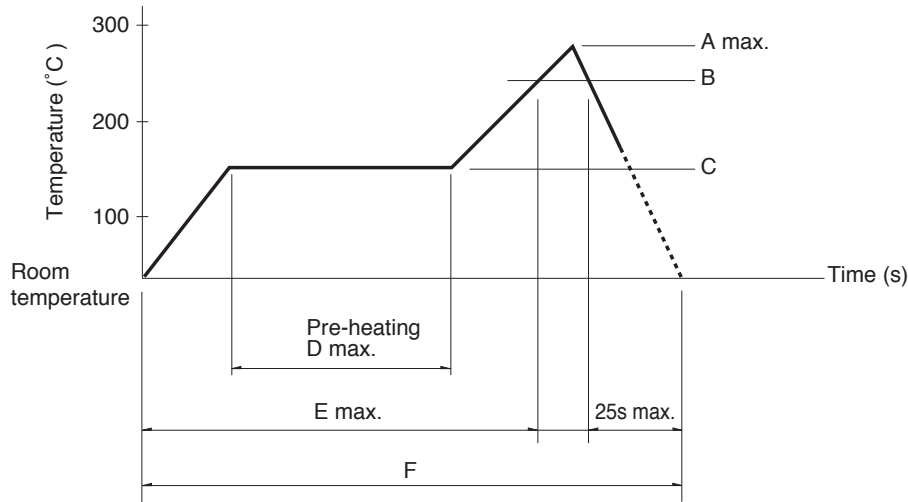

Series (Reflow type)	A (°C) 3s max.	B (°C)	C (°C)	D (s)	E (s)	F (s)
SRBQ	250	200	150±5	80 to 100	—	—

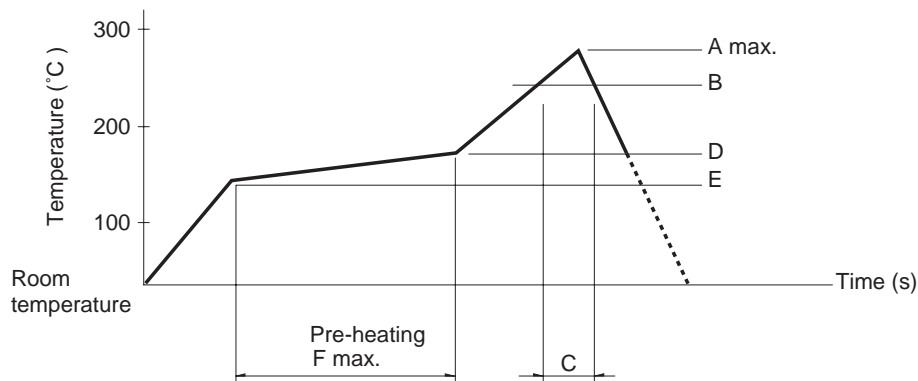

Series (Reflow type)	A (°C) 3s max.	B (°C)	C (s)	D (°C)	E (°C)	F (s)
SRBD	260	230	40	180	150	120

- Notes**
1. The condition mentioned above is the temperature on the mounting surface of a PC board. There are cases where the PC board's temperature greatly differs from that of the switch, depending on the PC board's material, size, thickness, etc. The above-stated conditions shall also apply to switch surface temperatures.
 2. Soldering conditions differ depending on reflow soldering machines. Prior verification of soldering condition is highly recommended.

Reference for Hand Soldering

Series	Soldering temperature	Soldering time
SRBQ, SRBM, SRBV, SRRM	350±10°C	3+1/0s
SRBQ (Reflow type)	350±5°C	3s max.

Reference for Dip Soldering

(For PC board terminal types)

Series	Items		Dip soldering	
	Preheating temperature	Preheating time	Soldering temperature	Duration of immersion
SRBM	100°C max.	60s max.	260±5°C	5s max.
SRBV, SRRM	—	—	260±5°C	10±1s
SRBQ	—	—	260±5°C	5±1s

Mouser Electronics

Authorized Distributor

Click to View Pricing, Inventory, Delivery & Lifecycle Information:

[Alps Alpine:](#)

[SRRM1C5400](#) [SRRM1C6200](#) [SRRM262400](#) [SRRM342800](#) [SRRM433700](#) [SRRM1C7800](#) [SRRM264300](#)
[SRRM254700](#)