

H11AA814 Series, H11A617 Series, H11A817 Series 4-Pin Phototransistor Optocouplers

Features

- AC input response (H11AA814 only)
- Compatible to Pb-free IR reflow soldering
- Compact 4-pin dual in-line package
- Current transfer ratio in selected groups:

H11AA814:	20-300%	H11A817:	50-600%
H11AA814A:	50-150%	H11A817A:	80-160%
H11A617A:	40%-80%	H11A817B:	130-260%
H11A617B:	63%-125%	H11A817C:	200-400%
H11A617C:	100%-200%	H11A817D:	300-600%
H11A617D:	160%-320%		
- C-UL, UL and VDE approved
- High input-output isolation voltage of 5000Vrms
- Minimum BV_{CEO} of 70V guaranteed

Applications

- H11AA814 Series
- AC line monitor
 - Unknown polarity DC sensor
 - Telephone line interface
- H11A617 and H11A817 Series
- Power supply regulators
 - Digital logic inputs
 - Microprocessor inputs

Description

The H11AA814 consists of two gallium arsenide infrared emitting diodes, connected in inverse parallel, driving a silicon phototransistor output in a 4-pin dual in-line package. The H11A617/817 Series consists of a gallium arsenide infrared emitting diode driving a silicon phototransistor in a 4-pin dual in-line package.

Package

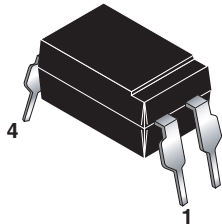

Schematics

H11AA814

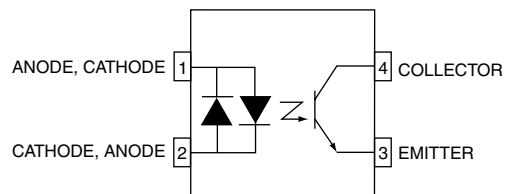

H11A617 & H11A817

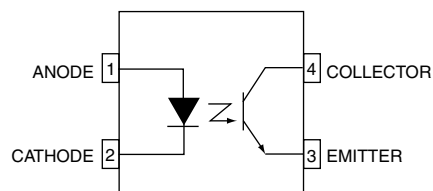

Absolute Maximum Ratings ($T_A = 25^\circ\text{C}$ Unless otherwise specified.)

Symbol	Parameter	Device*	Value	Units
TOTAL DEVICE				
T_{STG}	Storage Temperature	All	-55 to +150	$^\circ\text{C}$
T_{OPR}	Operating Temperature	All	-55 to +100	$^\circ\text{C}$
T_{SOL}	Lead Solder Temperature	All	260 for 10 sec	$^\circ\text{C}$
P_D	Total Device Power Dissipation (-55 $^\circ\text{C}$ to 50 $^\circ\text{C}$)	All	200	mW
EMITTER				
I_F	Continuous Forward Current	814 Series 617, 817 Series	± 50 50	mA
V_R	Reverse Voltage	617 Series 817 Series	6 6	V
P_D	LED Power Dissipation (25 $^\circ\text{C}$ ambient) No derating up to 100 $^\circ\text{C}$	All	70	mW
DETECTOR				
V_{CEO}	Collector-Emitter Voltage	All	70	V
V_{ECO}	Emitter-Collector Voltage	814, 817 Series 617 Series	6 7	V
I_C	Continuous Collector Current	All	50	mA
P_D	Detector Power Dissipation (25 $^\circ\text{C}$ ambient) Derate above 90 $^\circ\text{C}$	All	150	mW
			2.9	mW/ $^\circ\text{C}$

Electrical Characteristics ($T_A = 25^\circ\text{C}$ Unless otherwise specified.)

Individual Component Characteristics

Symbol	Parameter	Test Conditions	Device	Min.	Typ.*	Max.	Unit
EMITTER							
V_F	Input Forward Voltage	$I_F = 60\text{mA}$	617 Series		1.35	1.65	V
		$I_F = 20\text{mA}$	817 Series		1.2	1.5	
		$I_F = \pm 20\text{mA}$	814 Series		1.2	1.5	
I_R	Reverse Leakage Current	$V_R = 6.0\text{V}$	617 Series		.001	10	μA
		$V_R = 5.0\text{V}$	817 Series				
DETECTOR							
BV_{CEO}	Collector-Emitter Breakdown Voltage	$I_C = 0.1\text{ mA}, I_F = 0$	ALL	70	100		V
BV_{ECO}	Emitter-Collector Breakdown Voltage	$I_E = 10\ \mu\text{A}, I_F = 0$	814, 817 Series	6	10		V
			617 Series	7	10		
I_{CEO}	Collector-Emitter Dark Current	$V_{CE} = 10\text{V}, I_F = 0$	H11AA814/A, 817 Series, H11A617C/D		1	100	nA
			H11A617A/B			50	

*Typical values at $T_A=25^\circ\text{C}$

Transfer Characteristics ($T_A = 25^\circ\text{C}$ Unless otherwise specified.)

Symbol	DC Characteristic	Test Conditions	Device	Min	Typ*	Max	Unit
CTR	Current Transfer Ratio	$I_F = \pm 1\text{mA}, V_{CE} = 5\text{V}^{(1)}$	H11AA814	20		300	%
		$I_F = \pm 1\text{mA}, V_{CE} = 5\text{V}^{(1)}$	H11AA814A	50		150	%
		$(I_F = 10\text{mA}, V_{CE} = 5\text{V}^{(1)})$	H11A617A	40		80	%
			H11A617B	63		125	%
			H11A617C	100		200	%
			H11A617D	160		320	%
		$(I_F = 5\text{mA}, V_{CE} = 5\text{V}^{(1)})$	H11A817	50		600	%
			H11A817A	80		160	%
			H11A817B	130		260	%
			H11A817C	200		400	%
			H11A817D	300		600	%
		$I_F = 1\text{mA}, V_{CE} = 5\text{V}^{(1)}$	H11A617A	13			%
			H11A617B	22			%
			H11A617C	34			%
H11A617D	56				%		
$V_{CE(SAT)}$	Collector-Emitter Saturation Voltage	$I_C = 1\text{mA}, I_F = \pm 20\text{mA}$	814 series			0.2	V
		$I_C = 2.5\text{mA}, I_F = 10\text{mA}$	617 series			0.4	
		$I_C = 1\text{mA}, I_F = 20\text{mA}$	817 series			0.2	
AC CHARACTERISTIC							
t_r	Rise Time	$I_C = 2\text{mA}, V_{CE} = 2\text{V}, R_L = 100\Omega^{(2)}$	ALL		4	18	μs
t_f	Fall Time	$I_C = 2\text{mA}, V_{CE} = 2\text{V}, R_L = 100\Omega^{(2)}$	ALL		3	18	μs

Isolation Characteristics

Symbol	Characteristic	Test Conditions	Min.	Typ.*	Max.	Units
V_{ISO}	Input-Output Isolation Voltage (note 3)	($f = 60\text{Hz}, t = 1\text{min}$) ($I_{I-O} \leq 2\mu\text{A}$)	5000			Vac(rms)
R_{ISO}	Isolation Resistance	($V_{I-O} = 500\text{VDC}$)	5×10^{10}	10^{11}		Ω
C_{ISO}	Isolation Capacitance	($V_{I-O} = 0, f = 1\text{MHz}$)		0.6	1.0	pf

*Typical values at $T_A = 25^\circ\text{C}$.

Notes:

- Current Transfer Ratio (CTR) = $I_C/I_F \times 100\%$.
- For test circuit setup and waveforms, refer to Figure 13.
- For this test, Pins 1 and 2 are common, and Pins 3 and 4 are common.

Typical Performance Curves

Fig. 1 Current Transfer Ratio vs. Forward Current

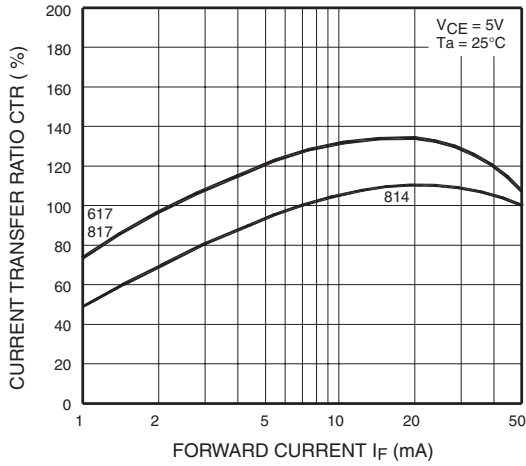

Fig. 2 Relative Current Transfer Ratio vs. Ambient Temperature

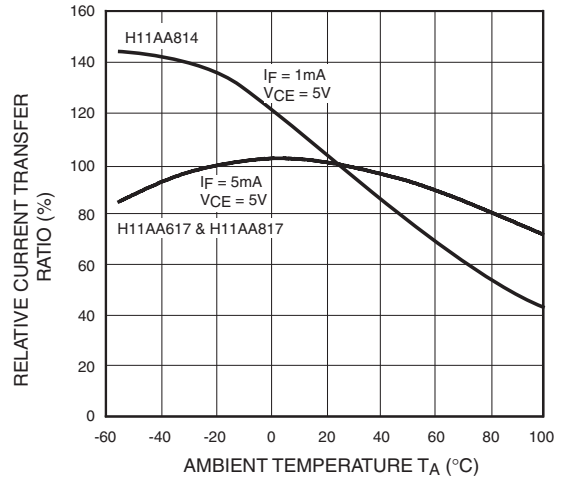

Fig. 3 Collector-Emitter Saturation Voltage vs. Ambient Temperature

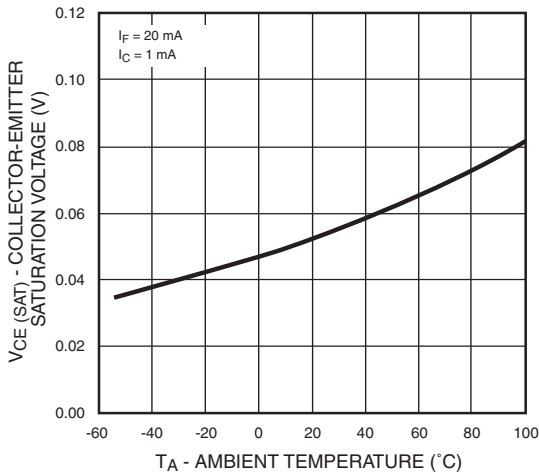

Fig. 4 Forward Current vs. Forward Voltage

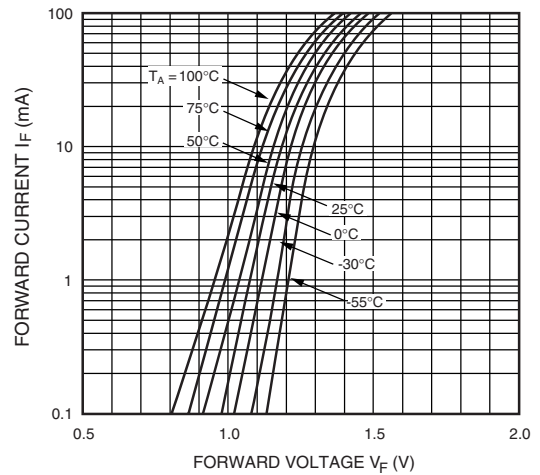

Fig. 5 Collector Current vs. Collector-Emitter Voltage (H11AA814)

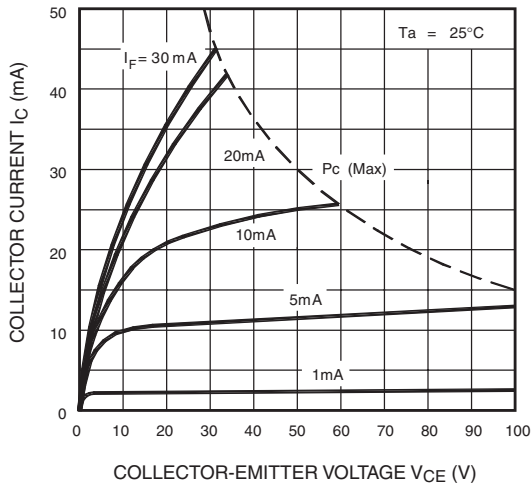
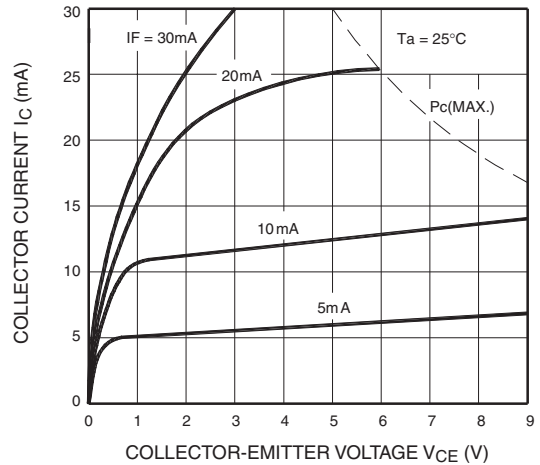

Fig. 6 Collector Current vs. Collector-Emitter Voltage (H11AA617 and H11AA817)



Typical Performance Curves (Continued)

Fig. 7 Collector Dark Current vs Ambient Temperature

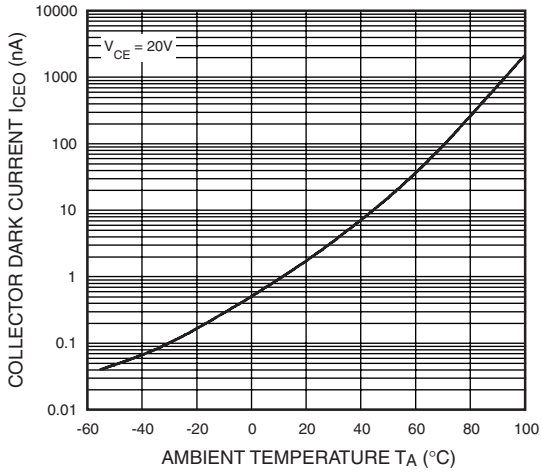

Fig. 8 Response Time vs. Load Resistance

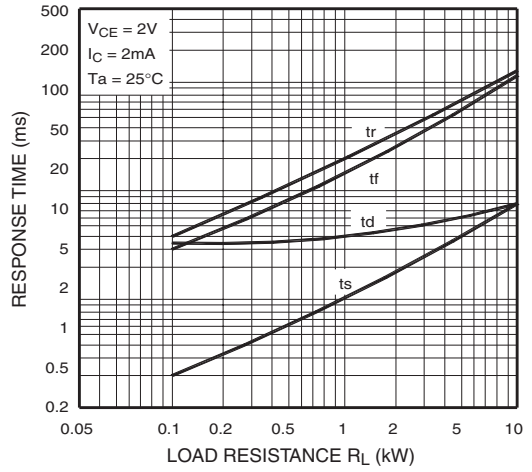

Fig. 9. Frequency Response (H11AA814)

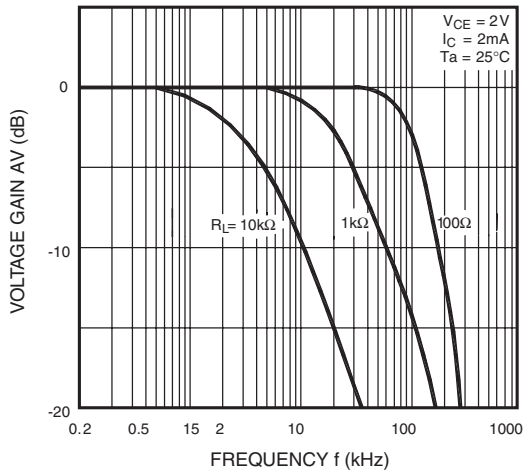

Fig. 10. Frequency Response (H11AA617 and H11AA817)

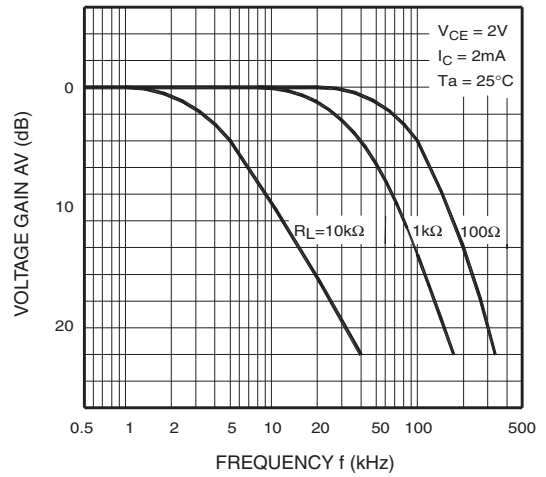

Fig. 11. LED Power Dissipation vs. Ambient Temperature

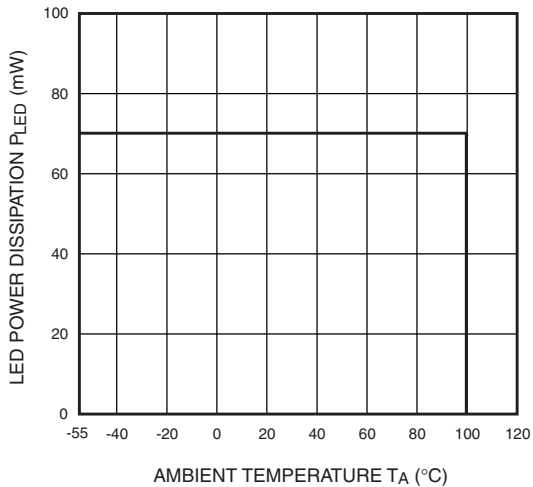
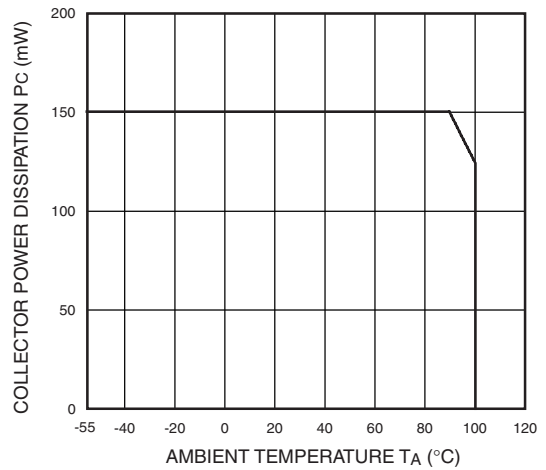

Fig. 12. Collector Power Dissipation vs. Ambient Temperature



Test Circuit

Figure 13. Test Circuit

Test Circuit for Response Time

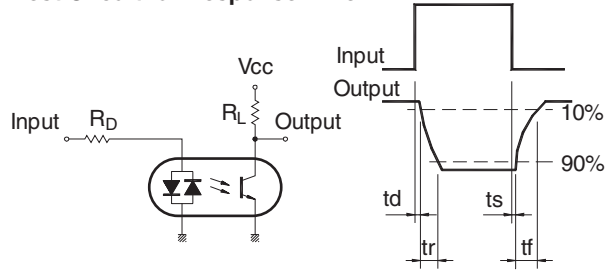

Test Circuit for Frequency Response

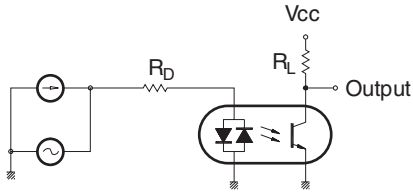

Package Dimensions

Through Hole

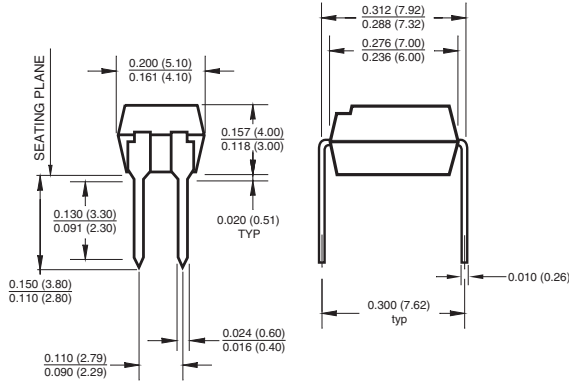

Surface Mount

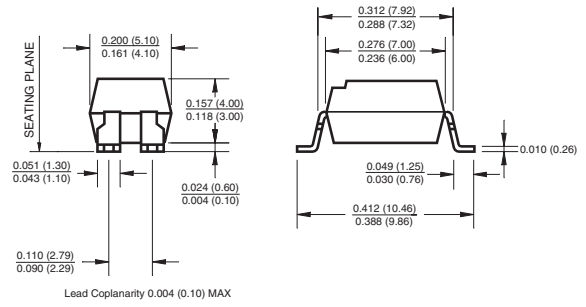

0.4" Lead Spacing

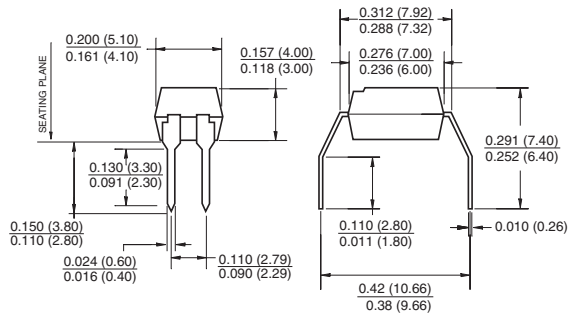

Footprint Dimensions (Surface Mount)

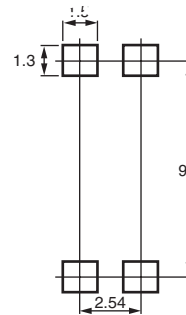

Note:

All dimensions are in inches (millimeters)

Ordering Information

Part Number Example	Description
H11AA814S	Surface Mount Lead Bend
H11AA814SD	Surface Mount; Tape and reel
H11AA814W	0.4" Lead Spacing
H11AA814300	VDE Approved
H11AA814300W	VDE Approved, 0.4" Lead Spacing
H11AA8143S	VDE Approved, Surface Mount
H11AA8143SD	VDE Approved, Surface Mount, Tape & Reel

*To specify the new construction version which needs 260°C max reflow peak temperature rating: add "NF098" to the end of the part number. The non-NF098 version is rated for 260°C peak reflow temperature only for parts marked with date code 0550 and later.

Marking Information

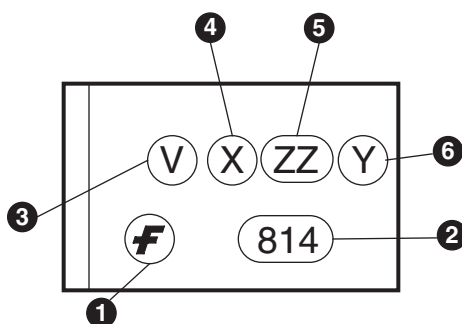

Definitions	
1	Fairchild logo
2	Device number
3	VDE mark (Note: Only appears on parts ordered with VDE option – See order entry table)
4	One digit year code
5	Two digit work week ranging from '01' to '53'
6	Assembly package code

Carrier Tape Specifications

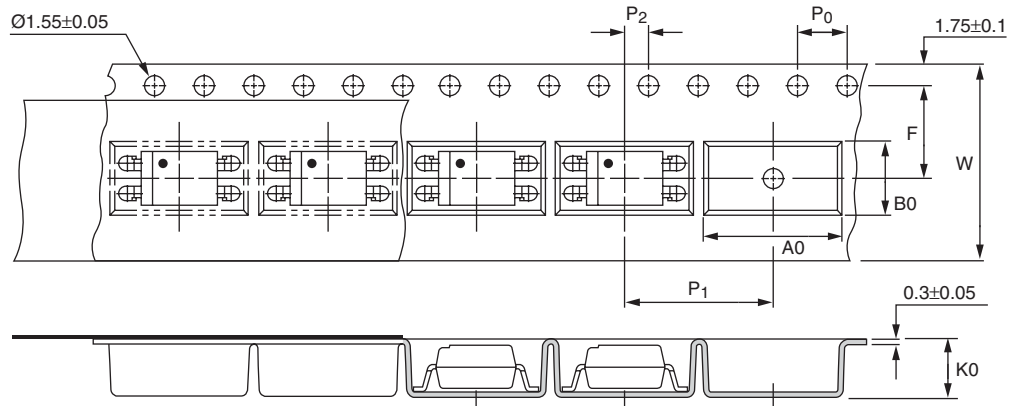

Note:

All dimensions are in millimeters

Description	Symbol	Dimensions in mm (inches)
Tape wide	W	16 ± 0.3 (.63)
Pitch of sprocket holes	P_0	4 ± 0.1 (.15)
Distance of compartment	F	7.5 ± 0.1 (.295)
	P_2	2 ± 0.1 (.079)
Distance of compartment to compartment	P_1	12 ± 0.1 (.472)
Compartment	A_0	10.45 ± 0.1 (.411)
	B_0	5.30 ± 0.1 (.209)
	K_0	4.25 ± 0.1 (.167)

Lead Free Recommended IR Reflow Condition

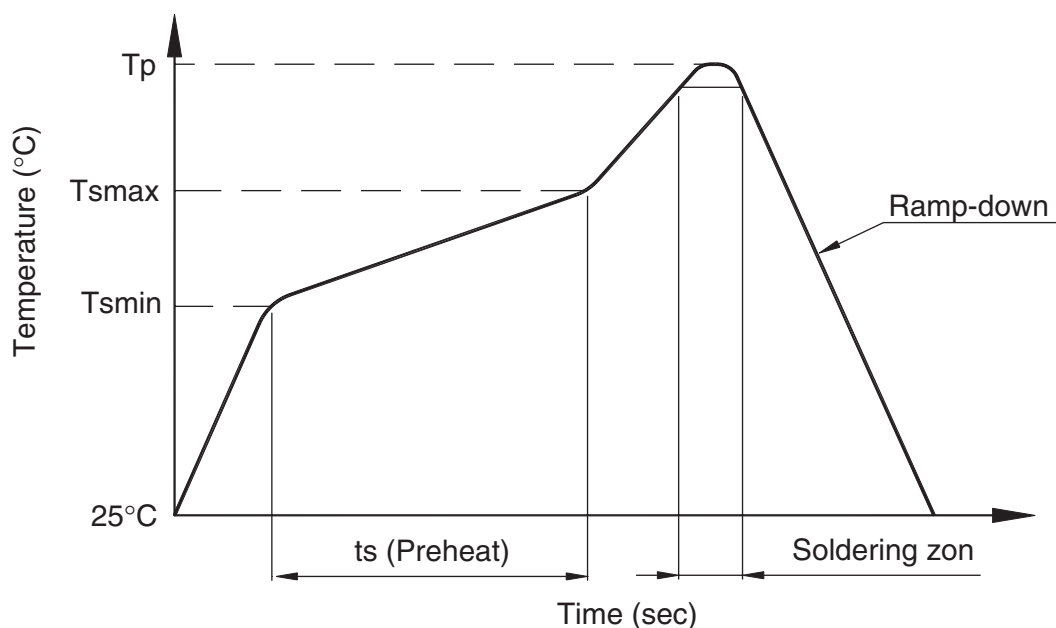

Profile Feature	Pb-Sn solder assembly	Lead Free assembly
Preheat condition (Tsmín-Tsmáx / ts)	100°C ~ 150°C 60 ~ 120 sec	150°C ~ 200°C 60 ~ 120 sec
Melt soldering zone	183°C 60 ~ 120 sec	217°C 30 ~ 90 sec
Peak temperature (Tp)	240 +0/-5°C	260 +0/-5°C
Ramp-down rate	6°C/sec max.	6°C/sec max.

Recommended Wave Soldering condition

Profile Feature	For all solder assembly
Peak temperature (Tp)	Max 260°C for 10 sec

TRADEMARKS

The following are registered and unregistered trademarks Fairchild Semiconductor owns or is authorized to use and is not intended to be an exhaustive list of all such trademarks.

ACE [™]	FACT Quiet Series [™]	OCX [™]	SILENT SWITCHER [®]	UniFET [™]
ActiveArray [™]	GlobalOptoisolator [™]	OCXPro [™]	SMART START [™]	UltraFET [®]
Bottomless [™]	GTO [™]	OPTOLOGIC [®]	SPM [™]	VCX [™]
Build it Now [™]	HiSeC [™]	OPTOPLANAR [™]	Stealth [™]	Wire [™]
CoolFET [™]	I ² C [™]	PACMAN [™]	SuperFET [™]	
CROSSVOLT [™]	i-Lo [™]	POP [™]	SuperSOT [™] -3	
DOME [™]	ImpliedDisconnect [™]	Power247 [™]	SuperSOT [™] -6	
EcoSPARK [™]	IntelliMAX [™]	PowerEdge [™]	SuperSOT [™] -8	
E ² CMOS [™]	ISOPLANAR [™]	PowerSaver [™]	SyncFET [™]	
EnSigna [™]	LittleFET [™]	PowerTrench [®]	TCM [™]	
FACT [™]	MICROCOUPLER [™]	QFET [®]	TinyBoost [™]	
FAST [®]	MicroFET [™]	QS [™]	TinyBuck [™]	
FASTr [™]	MicroPak [™]	QT Optoelectronics [™]	TinyPWM [™]	
FPS [™]	MICROWIRE [™]	Quiet Series [™]	TinyPower [™]	
FRFET [™]	MSX [™]	RapidConfigure [™]	TinyLogic [®]	
	MSXPro [™]	RapidConnect [™]	TINYOPTO [™]	
Across the board. Around the world. [™]		μSerDes [™]	TruTranslation [™]	
The Power Franchise [®]		ScalarPump [™]	UHC [™]	
Programmable Active Droop [™]				

DISCLAIMER

FAIRCHILD SEMICONDUCTOR RESERVES THE RIGHT TO MAKE CHANGES WITHOUT FURTHER NOTICE TO ANY PRODUCTS HEREIN TO IMPROVE RELIABILITY, FUNCTION, OR DESIGN. FAIRCHILD DOES NOT ASSUME ANY LIABILITY ARISING OUT OF THE APPLICATION OR USE OF ANY PRODUCT OR CIRCUIT DESCRIBED HEREIN; NEITHER DOES IT CONVEY ANY LICENSE UNDER ITS PATENT RIGHTS, NOR THE RIGHTS OF OTHERS. THESE SPECIFICATIONS DO NOT EXPAND THE TERMS OF FAIRCHILD'S WORLDWIDE TERMS AND CONDITIONS, SPECIFICALLY THE WARRANTY THEREIN, WHICH COVERS THESE PRODUCTS.

LIFE SUPPORT POLICY

FAIRCHILD'S PRODUCTS ARE NOT AUTHORIZED FOR USE AS CRITICAL COMPONENTS IN LIFE SUPPORT DEVICES OR SYSTEMS WITHOUT THE EXPRESS WRITTEN APPROVAL OF FAIRCHILD SEMICONDUCTOR CORPORATION.

As used herein:

- Life support devices or systems are devices or systems which, (a) are intended for surgical implant into the body, or (b) support or sustain life, or (c) whose failure to perform when properly used in accordance with instructions for use provided in the labeling, can be reasonably expected to result in significant injury to the user.
- A critical component is any component of a life support device or system whose failure to perform can be reasonably expected to cause the failure of the life support device or system, or to affect its safety or effectiveness.

PRODUCT STATUS DEFINITIONS

Definition of Terms

Datasheet Identification	Product Status	Definition
Advance Information	Formative or In Design	This datasheet contains the design specifications for product development. Specifications may change in any manner without notice.
Preliminary	First Production	This datasheet contains preliminary data, and supplementary data will be published at a later date. Fairchild Semiconductor reserves the right to make changes at any time without notice to improve design.
No Identification Needed	Full Production	This datasheet contains final specifications. Fairchild Semiconductor reserves the right to make changes at any time without notice to improve design.
Obsolete	Not In Production	This datasheet contains specifications on a product that has been discontinued by Fairchild semiconductor. The datasheet is printed for reference information only.

Rev. I20

Mouser Electronics

Authorized Distributor

Click to View Pricing, Inventory, Delivery & Lifecycle Information:

Fairchild Semiconductor:

[H11A817B300](#) [H11A817B3S](#) [H11A817BSD](#) [H11A817B](#) [H11A817B300W](#) [H11A817B3SD](#) [H11A817BW](#)
[H11A817BS](#) [H11A817300W](#) [H11A817SD](#) [H11A617B3S](#) [H11A8173SD](#) [H11A817A3SD](#) [H11AA8143SD](#)
[H11A817A_Q](#) [H11AA814AS](#) [H11AA814](#) [H11A617B300](#) [H11AA814AW](#) [H11A617D3S](#) [H11A817CW](#) [H11AA814ASD](#)
[H11A817DS](#) [H11A817C300](#) [H11A817B300_Q](#) [H11A817A300W](#) [H11A617AS](#) [H11A617B3SD](#) [H11A617BSD](#)
[H11A817D300W](#) [H11A817_Q](#) [H11A617A3SD](#) [H11A617D](#) [H11A617D3SD](#) [H11A817D_Q](#) [H11AA814A_Q](#)
[H11A617DS](#) [H11A617C3SD](#) [H11AA814W](#) [H11A617C300](#) [H11A617C](#) [H11AA814A3SD](#) [H11AA814ASD_Q](#)
[H11A617BS](#) [H11A817CSD_F098](#) [H11A617C3S](#) [H11A617D300W](#) [H11A617AW](#) [H11A817DSD](#) [H11A617A](#)
[H11A817D](#) [H11A617CW](#) [H11A617DSD](#) [H11A817A3SD_Q](#) [H11AA814A3S](#) [H11AA814A300W](#) [H11AA8143S](#)
[H11A617B](#) [H11A817A](#) [H11A617C300W](#) [H11A817B_Q](#) [H11A617A300](#) [H11A817DW](#) [H11A817A300](#) [H11A617CS](#)
[H11A617ASD](#) [H11A817W](#) [H11A817D3S](#) [H11A817C3S](#) [H11AA814A300](#) [H11A617CSD](#) [H11AA814300W](#)
[H11A617A300W](#) [H11A817S](#) [H11A817AW](#) [H11A617BW](#) [H11A817CSD](#) [H11A817C3SD](#) [H11A817D3SD](#) [H11A8173S](#)
[H11AA814A](#) [H11A617DW](#) [H11A817AS](#) [H11A817C3SD_Q](#) [H11A817ASD](#) [H11A817D300](#) [H11AA814SD](#)
[H11A817C](#) [H11A817](#) [H11A617B300W](#) [H11A817CS](#) [H11AA814_Q](#) [H11A817C_Q](#) [H11A817A3S](#) [H11A617A3S](#)
[H11A817AS_Q](#) [H11A817C300W](#) [H11AA814300](#) [H11A817300](#) [H11AA814S](#)