

**GENERAL DESCRIPTION**

The SP6260 family is a series of CMOS positive low noise voltage regulators capable of delivering up to 200mA of continuous current.

Each of these devices consists of a voltage reference, an error amplifier, a resistor network for setting the output voltage, a current limit circuit for current protection and a chip enable circuit.

The SP6260 series feature high ripple rejection, low dropout voltage, low noise, high output voltage accuracy and low current consumption which make them ideal for use in various battery-powered and hand-held devices.

The SP6260 series is offered in the following fixed output voltage options: 1.2V, 1.5V, 1.8V, 2.5V, 2.8V, 3.0V, 3.2V and 3.3V.

The SP6260 family is available in standard lead free, RoHS compliant 5-pin SOT-23 package.

**APPLICATIONS**

- **Hand Held Equipments**
- **Wireless Communication Devices**
- **Battery Powered Equipments**
- **Industrial and Medical Equipments**

**FEATURES**

- **200mA Continuous Output Current**
  - 150mV Dropout Voltage @  $I_{OUT}=100mA$  (Except 1.2V and 1.5V Version)
  - 1.2V to 3.3V Fixed Output Voltages
  - $\pm 2\%$  Output Voltage Accuracy
- **2V Minimum Input Voltage**
- **30 $\mu$ Vrms Output Noise (10Hz-100KHz)**
- **70dB Power Supply Rejection Ratio**
- **4mV Line Regulation (typ)**
- **12mV Load Regulation (typ)**
- **Low Standby Current: 0.1 $\mu$ A Typical**
- **Low Quiescent Current: 25 $\mu$ A Typical**
- **Lead Free, RoHS Compliant 5-pin SOT-23 Package**

**3.3V version available, others obsolete**

**TYPICAL APPLICATION DIAGRAM**

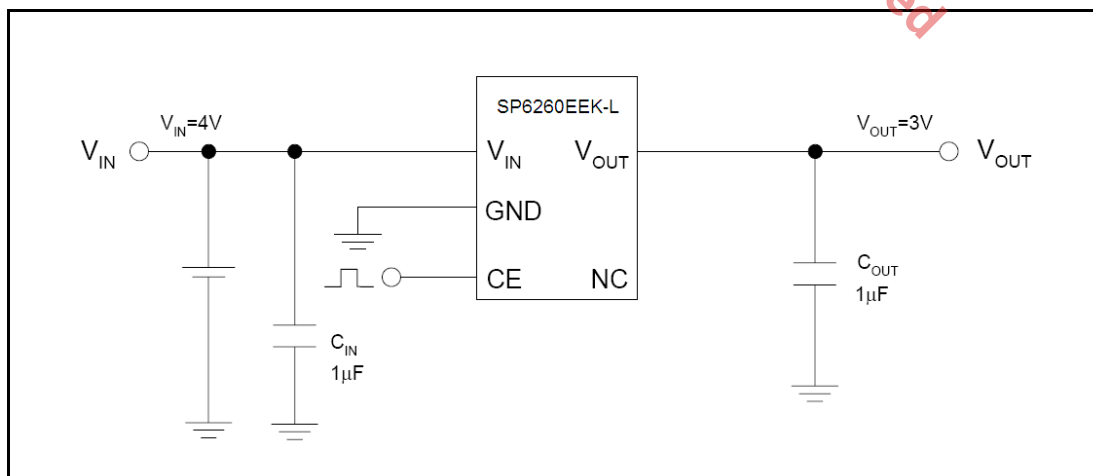

Fig. 1: SP6260 Application Diagram

**ABSOLUTE MAXIMUM RATINGS**

These are stress ratings only and functional operation of the device at these ratings or any other above those indicated in the operation sections of the specifications below is not implied. Exposure to absolute maximum rating conditions for extended periods of time may affect reliability.

Input Voltage  $V_{IN}$  ..... 6.5V  
 Enable Pin Input Voltage ..... -0.3 to  $V_{IN}+0.3V$   
 Output Current..... 300mA  
 Junction Temperature ..... 150°C  
 Storage Temperature Range ..... -65°C to 150°C  
 Lead Soldering (Sold. 10sec) ..... 260°C  
 ESD Rating (HBM - Human Body Model)..... 2kV  
 ESD Rating (MM - Machine Model) ..... 200V

**OPERATING RATINGS**

Input Voltage Range  $V_{IN}$ ..... 2.0 to 6.0V  
 Junction Temperature Range  $T_J$ ..... -40°C to 85°C  
 Thermal Resistance  $\theta_{JA}$  ..... 250°C/W  
 Thermal Resistance  $\theta_{JC}$  ..... 74°C/W

**ELECTRICAL SPECIFICATIONS**

Specifications with standard type are for an Operating Junction Temperature of  $T_J = 25^\circ C$  only; limits applying over the full Operating Junction Temperature range of -40°C to 85°C are denoted by a “\*”. Minimum and Maximum limits are guaranteed through test, design, or statistical correlation. Typical values represent the most likely parametric norm at  $T_J = 25^\circ C$ , and are provided for reference purposes only.

**SP6260HEK (1.2V) 1.2V version is obsolete**

Unless otherwise indicated,  $V_{IN} = 2.2V$ ,  $C_{IN} = 1\mu F$ ,  $C_{OUT} = 1\mu F$ .

Parameter	Min.	Typ.	Max.	Units	Conditions
Output Voltage $V_{OUT}$	1.176	1.2	1.224	V	$V_{IN}=2.2V$ $1mA \leq I_{OUT} \leq 30mA$
Input Voltage $V_{IN}$			6	V	
Output Current $I_{OUT}$	200			mA	$V_{IN}-V_{OUT}=1V$
Load Regulation $V_{RLOAD}$		12	40	mV	$V_{IN}=2.2V$ $1mA \leq I_{OUT} \leq 80mA$
Line Regulation $V_{RLINE}$		4	16	mV	$2.2V \leq V_{IN} \leq 6V$ $I_{OUT}=30mA$
Dropout Voltage $V_{DROP}$		700	900	mV	$I_{OUT}=10mA$
		700	900		$I_{OUT}=100mA$
		700	900		$I_{OUT}=150mA$
		700	900		$I_{OUT}=200mA$
Quiescent Current $I_Q$		25	50	$\mu A$	$V_{IN}=2.2V, I_{OUT}=0mA$
Standby Current $I_{STD}$		0.1	1	$\mu A$	$V_{IN}=2.2V$ $V_{CE}$ in OFF mode
Power Supply Rejection Ratio PSRR		70		dB	Ripple 0.5V <sub>p-p</sub> , f=10kHz $V_{IN}=2.5V$
Output Voltage Temperature Coefficient		$\pm 120$		$\mu V/^\circ C$	• $\Delta V_{OUT}/\Delta T$
		$\pm 100$		ppm/ $^\circ C$	• $(\Delta V_{OUT}/V_{OUT})/\Delta T$
Short Current Limit $I_{LIMIT}$		50		mA	$V_{OUT}=0V$
RMS Output Noise $V_{NOISE}$		30		$\mu V_{rms}$	$T_A=25^\circ C$ $10Hz \leq f \leq 100kHz$
CE “High” Voltage	1.5			V	CE input voltage “High”
CE “Low” Voltage			0.25	V	CE input voltage “Low”
CE Pull-down Resistance $R_{PD}$	2.5	5	10	M $\Omega$	

**SP6260AEK (1.5V) 1.5V version is obsolete**

 Unless otherwise indicated,  $V_{IN} = 2.5V$ ,  $C_{IN} = 1\mu F$ ,  $C_{OUT} = 1\mu F$ .

Parameter	Min.	Typ.	Max.	Units	Conditions
Output Voltage $V_{OUT}$	1.47	1.5	1.53	V	$V_{IN}=2.5V$ $1mA \leq I_{OUT} \leq 30mA$
Input Voltage $V_{IN}$			6	V	
Output Current $I_{OUT}$	200			mA	$V_{IN}-V_{OUT}=1V$
Load Regulation $V_{RLOAD}$		12	40	mV	$V_{IN}=2.5V$ $1mA \leq I_{OUT} \leq 80mA$
Line Regulation $V_{RLINE}$		4	16	mV	$2.3V \leq V_{IN} \leq 6V$ $I_{OUT}=30mA$
Dropout Voltage $V_{DROP}$		400	600	mV	$I_{OUT}=10mA$
		400	600		$I_{OUT}=100mA$
		400	600		$I_{OUT}=150mA$
		400	600		$I_{OUT}=200mA$
Quiescent Current $I_Q$		25	50	$\mu A$	$V_{IN}=2.5V, I_{OUT}=0mA$
Standby Current $I_{STD}$		0.1	1	$\mu A$	$V_{IN}=2.5V$ $V_{CE}$ in OFF mode
Power Supply Rejection Ratio PSRR		70		dB	Ripple 0.5V <sub>p-p</sub> , f=10kHz $V_{IN}=2.5V$
Output Voltage Temperature Coefficient		$\pm 150$		$\mu V/^\circ C$	• $\Delta V_{OUT}/\Delta T$
		$\pm 100$		ppm/ $^\circ C$	• $(\Delta V_{OUT}/V_{OUT})/\Delta T$
Short Current Limit $I_{LIMIT}$		50		mA	$V_{OUT}=0V$
RMS Output Noise $V_{NOISE}$		30		$\mu V_{rms}$	$T_A=25^\circ C$ $10Hz \leq f \leq 100kHz$
CE "High" Voltage	1.5			V	CE input voltage "High"
CE "Low" Voltage			0.25	V	CE input voltage "Low"
CE Pull-down Resistance $R_{PD}$	2.5	5	10	M $\Omega$	

**SP6260BEK (1.8V) 1.8V version is obsolete**

 Unless otherwise indicated,  $V_{IN} = 2.8V$ ,  $C_{IN} = 1\mu F$ ,  $C_{OUT} = 1\mu F$ .

Parameter	Min.	Typ.	Max.	Units	Conditions
Output Voltage $V_{OUT}$	1.764	1.8	1.836	V	$V_{IN}=2.8V$ $1mA \leq I_{OUT} \leq 30mA$
Input Voltage $V_{IN}$			6	V	
Output Current $I_{OUT}$	200			mA	$V_{IN}-V_{OUT}=1V$
Load Regulation $V_{RLOAD}$		12	40	mV	$V_{IN}=2.8V$ $1mA \leq I_{OUT} \leq 80mA$
Line Regulation $V_{RLINE}$		4	16	mV	$2.3V \leq V_{IN} \leq 6V$ $I_{OUT}=30mA$
Dropout Voltage $V_{DROP}$		20	40	mV	$I_{OUT}=10mA$
		150	300		$I_{OUT}=100mA$
		200	400		$I_{OUT}=150mA$
		250	500		$I_{OUT}=200mA$
Quiescent Current $I_Q$		25	50	$\mu A$	$V_{IN}=2.8V, I_{OUT}=0mA$
Standby Current $I_{STD}$		0.1	1	$\mu A$	$V_{IN}=2.8V$ $V_{CE}$ in OFF mode
Power Supply Rejection Ratio PSRR		70		dB	Ripple 0.5V <sub>p-p</sub> , f=10kHz $V_{IN}=2.5V$
Output Voltage Temperature Coefficient		$\pm 180$		$\mu V/^\circ C$	• $\Delta V_{OUT}/\Delta T$
		$\pm 100$		ppm/ $^\circ C$	• $(\Delta V_{OUT}/V_{OUT})/\Delta T$

Short Current Limit $I_{LIMIT}$		50		mA	$V_{OUT}=0V$
RMS Output Noise $V_{NOISE}$		30		$\mu V_{rms}$	$T_A=25^\circ C$ $10Hz \leq f \leq 100kHz$
CE "High" Voltage	1.5			V	CE input voltage "High"
CE "Low" Voltage			0.25	V	CE input voltage "Low"
CE Pull-down Resistance $R_{PD}$	2.5	5	10	$M\Omega$	

**SP6260CEK (2.5V) 2.5V version is obsolete**

Unless otherwise indicated,  $V_{IN} = 3.5V$ ,  $C_{IN} = 1\mu F$ ,  $C_{OUT} = 1\mu F$ .

Parameter	Min.	Typ.	Max.	Units	Conditions
Output Voltage $V_{OUT}$	2.45	2.5	2.55	V	$V_{IN}=3.5V$ $1mA \leq I_{OUT} \leq 30mA$
Input Voltage $V_{IN}$			6	V	
Output Current $I_{OUT}$	200			mA	$V_{IN}-V_{OUT}=1V$
Load Regulation $V_{RLOAD}$		12	40	mV	$V_{IN}=3.5V$ $1mA \leq I_{OUT} \leq 80mA$
Line Regulation $V_{RLINE}$		4	16	mV	$3.0V \leq V_{IN} \leq 6V$ $I_{OUT}=30mA$
Dropout Voltage $V_{DROP}$		20	40	mV	$I_{OUT}=10mA$
		150	300		$I_{OUT}=100mA$
		200	400		$I_{OUT}=150mA$
		250	500		$I_{OUT}=200mA$
Quiescent Current $I_Q$		25	50	$\mu A$	$V_{IN}=3.5V, I_{OUT}=0mA$
Standby Current $I_{STD}$		0.1	1	$\mu A$	$V_{IN}=3.5V$ $V_{CE}$ in OFF mode
Power Supply Rejection Ratio PSRR		70		dB	Ripple 0.5V <sub>p-p</sub> , $f=10kHz$ $V_{IN}=2.5V$
Output Voltage Temperature Coefficient		$\pm 250$		$\mu V/^\circ C$	$\bullet \Delta V_{OUT}/\Delta T$
		$\pm 100$		ppm/ $^\circ C$	$\bullet (\Delta V_{OUT}/V_{OUT})/\Delta T$
Short Current Limit $I_{LIMIT}$		50		mA	$V_{OUT}=0V$
RMS Output Noise $V_{NOISE}$		30		$\mu V_{rms}$	$T_A=25^\circ C$ $10Hz \leq f \leq 100kHz$
CE "High" Voltage	1.5			V	CE input voltage "High"
CE "Low" Voltage			0.25	V	CE input voltage "Low"
CE Pull-down Resistance $R_{PD}$	2.5	5	10	$M\Omega$	

**SP6260DEK (2.8V) 2.8V version is obsolete**

Unless otherwise indicated,  $V_{IN} = 3.8V$ ,  $C_{IN} = 1\mu F$ ,  $C_{OUT} = 1\mu F$ .

Parameter	Min.	Typ.	Max.	Units	Conditions
Output Voltage $V_{OUT}$	2.744	2.8	2.856	V	$V_{IN}=3.8V$ $1mA \leq I_{OUT} \leq 30mA$
Input Voltage $V_{IN}$			6	V	
Output Current $I_{OUT}$	200			mA	$V_{IN}-V_{OUT}=1V$
Load Regulation $V_{RLOAD}$		12	40	mV	$V_{IN}=3.8V$ $1mA \leq I_{OUT} \leq 80mA$
Line Regulation $V_{RLINE}$		4	16	mV	$3.3V \leq V_{IN} \leq 6V$ $I_{OUT}=30mA$
Dropout Voltage $V_{DROP}$		20	40	mV	$I_{OUT}=10mA$
		150	300		$I_{OUT}=100mA$
		200	400		$I_{OUT}=150mA$
		250	500		$I_{OUT}=200mA$

Quiescent Current $I_Q$		25	50	$\mu\text{A}$	$V_{IN}=3.8\text{V}, I_{OUT}=0\text{mA}$
Standby Current $I_{STD}$		0.1	1	$\mu\text{A}$	$V_{IN}=3.8\text{V}$ $V_{CE}$ in OFF mode
Power Supply Rejection Ratio PSRR		70		dB	Ripple 0.5V <sub>p-p</sub> , $f=10\text{kHz}$ $V_{IN}=2.5\text{V}$
Output Voltage Temperature Coefficient		$\pm 280$		$\mu\text{V}/^\circ\text{C}$	• $\Delta V_{OUT}/\Delta T$
		$\pm 100$		ppm/ $^\circ\text{C}$	• $(\Delta V_{OUT}/V_{OUT})/\Delta T$
Short Current Limit $I_{LIMIT}$		50		mA	$V_{OUT}=0\text{V}$
RMS Output Noise $V_{NOISE}$		30		$\mu\text{V}_{rms}$	$T_A=25^\circ\text{C}$ $10\text{Hz}\leq f\leq 100\text{kHz}$
CE "High" Voltage	1.5			V	CE input voltage "High"
CE "Low" Voltage			0.25	V	CE input voltage "Low"
CE Pull-down Resistance $R_{PD}$	2.5	5	10	$\text{M}\Omega$	

**SP6260EEK (3.0V) 3.0V version is obsolete**

Unless otherwise indicated,  $V_{IN} = 4.0\text{V}$ ,  $C_{IN} = 1\mu\text{F}$ ,  $C_{OUT} = 1\mu\text{F}$ .

Parameter	Min.	Typ.	Max.	Units	Conditions
Output Voltage $V_{OUT}$	2.940	3.0	3.060	V	$V_{IN}=4.0\text{V}$ $1\text{mA}\leq I_{OUT}\leq 30\text{mA}$
Input Voltage $V_{IN}$			6	V	
Output Current $I_{OUT}$	200			mA	$V_{IN}-V_{OUT}=1\text{V}$
Load Regulation $V_{RLOAD}$		12	40	mV	$V_{IN}=4.0\text{V}$ $1\text{mA}\leq I_{OUT}\leq 80\text{mA}$
Line Regulation $V_{RLINE}$		4	16	mV	$3.5\text{V}\leq V_{IN}\leq 6\text{V}$ $I_{OUT}=30\text{mA}$
Dropout Voltage $V_{DROP}$		20	40	mV	$I_{OUT}=10\text{mA}$
		150	300		$I_{OUT}=100\text{mA}$
		200	400		$I_{OUT}=150\text{mA}$
		250	500		$I_{OUT}=200\text{mA}$
Quiescent Current $I_Q$		25	50	$\mu\text{A}$	$V_{IN}=4.0\text{V}, I_{OUT}=0\text{mA}$
Standby Current $I_{STD}$		0.1	1	$\mu\text{A}$	$V_{IN}=4.0\text{V}$ $V_{CE}$ in OFF mode
Power Supply Rejection Ratio PSRR		70		dB	Ripple 0.5V <sub>p-p</sub> , $f=10\text{kHz}$ $V_{IN}=2.5\text{V}$
Output Voltage Temperature Coefficient		$\pm 300$		$\mu\text{V}/^\circ\text{C}$	• $\Delta V_{OUT}/\Delta T$
		$\pm 100$		ppm/ $^\circ\text{C}$	• $(\Delta V_{OUT}/V_{OUT})/\Delta T$
Short Current Limit $I_{LIMIT}$		50		mA	$V_{OUT}=0\text{V}$
RMS Output Noise $V_{NOISE}$		30		$\mu\text{V}_{rms}$	$T_A=25^\circ\text{C}$ $10\text{Hz}\leq f\leq 100\text{kHz}$
CE "High" Voltage	1.5			V	CE input voltage "High"
CE "Low" Voltage			0.25	V	CE input voltage "Low"
CE Pull-down Resistance $R_{PD}$	2.5	5	10	$\text{M}\Omega$	

**SP6260FEK (3.2V) 3.2V version is obsolete**

Unless otherwise indicated,  $V_{IN} = 4.2\text{V}$ ,  $C_{IN} = 1\mu\text{F}$ ,  $C_{OUT} = 1\mu\text{F}$ .

Parameter	Min.	Typ.	Max.	Units	Conditions
Output Voltage $V_{OUT}$	3.136	3.2	3.264	V	$V_{IN}=4.2\text{V}$ $1\text{mA}\leq I_{OUT}\leq 30\text{mA}$
Input Voltage $V_{IN}$			6	V	
Output Current $I_{OUT}$	200			mA	$V_{IN}-V_{OUT}=1\text{V}$

Load Regulation $V_{RLOAD}$		12	40	mV	$V_{IN}=4.2V$ $1mA \leq I_{OUT} \leq 80mA$
Line Regulation $V_{RLINE}$		4	16	mV	$3.7V \leq V_{IN} \leq 6V$ $I_{OUT}=30mA$
Dropout Voltage $V_{DROP}$		20	40	mV	$I_{OUT}=10mA$
		150	300		$I_{OUT}=100mA$
		200	400		$I_{OUT}=150mA$
		250	500		$I_{OUT}=200mA$
Quiescent Current $I_Q$		25	50	$\mu A$	$V_{IN}=4.2V, I_{OUT}=0mA$
Standby Current $I_{STD}$		0.1	1	$\mu A$	$V_{IN}=4.2V$ $V_{CE}$ in OFF mode
Power Supply Rejection Ratio PSRR		70		dB	Ripple 0.5V <sub>p-p</sub> , f=10kHz $V_{IN}=2.5V$
Output Voltage Temperature Coefficient		$\pm 320$		$\mu V/^\circ C$	• $\Delta V_{OUT}/\Delta T$
		$\pm 100$		ppm/ $^\circ C$	• $(\Delta V_{OUT}/V_{OUT})/\Delta T$
Short Current Limit $I_{LIMIT}$		50		mA	$V_{OUT}=0V$
RMS Output Noise $V_{NOISE}$		30		$\mu V_{rms}$	$T_A=25^\circ C$ $10Hz \leq f \leq 100kHz$
CE "High" Voltage	1.5			V	CE input voltage "High"
CE "Low" Voltage			0.25	V	CE input voltage "Low"
CE Pull-down Resistance $R_{PD}$	2.5	5	10	M $\Omega$	

**SP6260GEK (3.3V) Available**

Unless otherwise indicated,  $V_{IN} = 4.3V$ ,  $C_{IN} = 1\mu F$ ,  $C_{OUT} = 1\mu F$ .

Parameter	Min.	Typ.	Max.	Units	Conditions
Output Voltage $V_{OUT}$	3.234	3.3	3.366	V	$V_{IN}=4.3V$ $1mA \leq I_{OUT} \leq 30mA$
Input Voltage $V_{IN}$			6	V	
Output Current $I_{OUT}$	200			mA	$V_{IN}-V_{OUT}=1V$
Load Regulation $V_{RLOAD}$		12	40	mV	$V_{IN}=4.3V$ $1mA \leq I_{OUT} \leq 80mA$
Line Regulation $V_{RLINE}$		4	16	mV	$3.8V \leq V_{IN} \leq 6V$ $I_{OUT}=30mA$
Dropout Voltage $V_{DROP}$		20	40	mV	$I_{OUT}=10mA$
		150	300		$I_{OUT}=100mA$
		200	400		$I_{OUT}=150mA$
		250	500		$I_{OUT}=200mA$
Quiescent Current $I_Q$		25	50	$\mu A$	$V_{IN}=4.3V, I_{OUT}=0mA$
Standby Current $I_{STD}$		0.1	1	$\mu A$	$V_{IN}=4.3V$ $V_{CE}$ in OFF mode
Power Supply Rejection Ratio PSRR		70		dB	Ripple 0.5V <sub>p-p</sub> , f=10kHz $V_{IN}=2.5V$
Output Voltage Temperature Coefficient		$\pm 330$		$\mu V/^\circ C$	• $\Delta V_{OUT}/\Delta T$
		$\pm 100$		ppm/ $^\circ C$	• $(\Delta V_{OUT}/V_{OUT})/\Delta T$
Short Current Limit $I_{LIMIT}$		50		mA	$V_{OUT}=0V$
RMS Output Noise $V_{NOISE}$		30		$\mu V_{rms}$	$T_A=25^\circ C$ $10Hz \leq f \leq 100kHz$
CE "High" Voltage	1.5			V	CE input voltage "High"
CE "Low" Voltage			0.25	V	CE input voltage "Low"
CE Pull-down Resistance $R_{PD}$	2.5	5	10	M $\Omega$	

**BLOCK DIAGRAM**

Fig. 2: SP6260 Block Diagram

**PIN ASSIGNMENT**

Fig. 3: SP6260 Pin Assignment

**PIN DESCRIPTION**

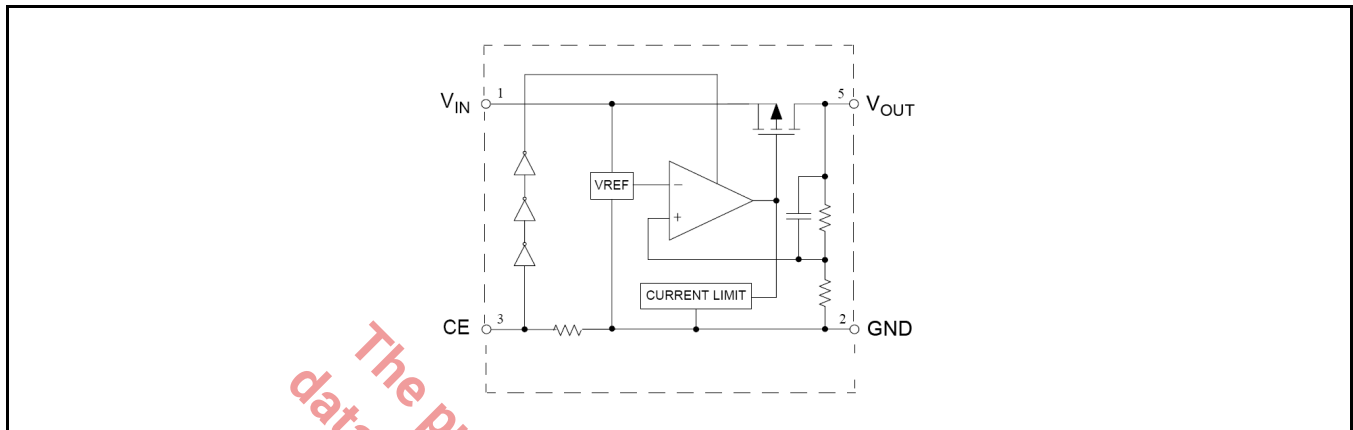
Name	Pin Number	Description
V <sub>IN</sub>	1	Input voltage
GND	2	Ground
CE	3	Enable input pin. high=enable low=shutdown
NC	4	No connection
V <sub>OUT</sub>	5	Regulated output voltage

**ORDERING INFORMATION<sup>(1)</sup>**

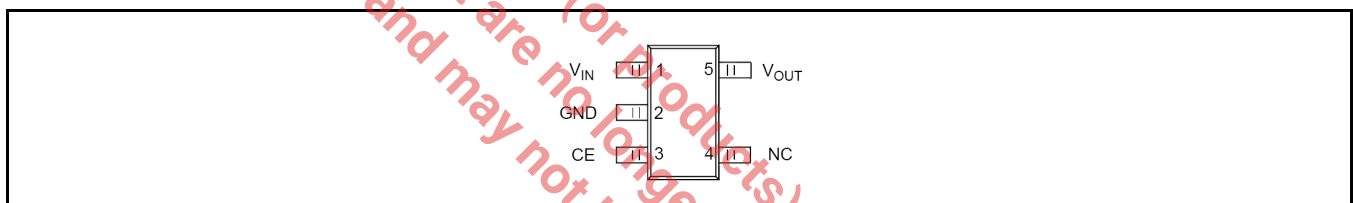
Part Number	Junction Temperature Range	Package	Packing Method	Lead free <sup>(2)</sup>	Note 1
SP6260GEK-L/TR	-40°C to +85°C	SOT-23-5	Tape & Reel	Yes	3.3V version

Notes:

1. Refer to [www.maxlinear.com/SP6260](http://www.maxlinear.com/SP6260) for most up-to-date Ordering Information.
2. Visit [www.maxlinear.com](http://www.maxlinear.com) for additional information on Environmental Rating.

**TYPICAL PERFORMANCE CHARACTERISTICS**

All data taken at  $V_{IN} = 2.7V$  to  $5.5V$ ,  $T_J = T_A = 25^\circ C$ , unless otherwise specified - Schematic and BOM from Application Information section of this datasheet.

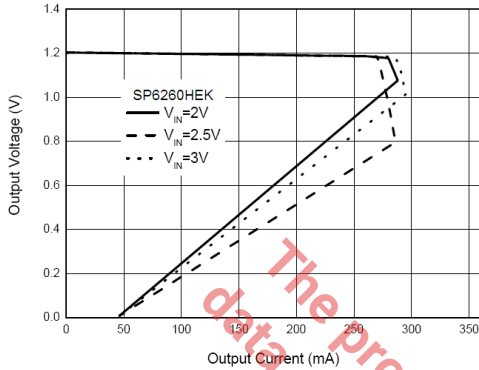

Fig. 4: Output Voltage vs. Output Current SP6260HEK (1.2V)

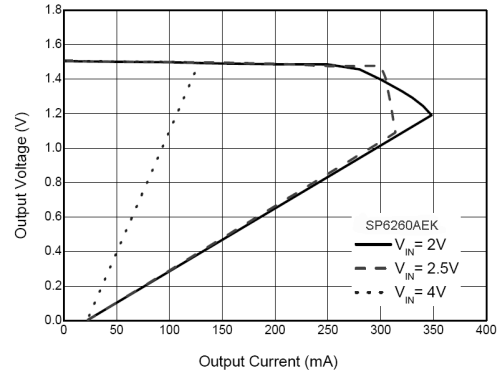

Fig. 5: Output Voltage vs. Output Current SP6260AEK (1.5V)

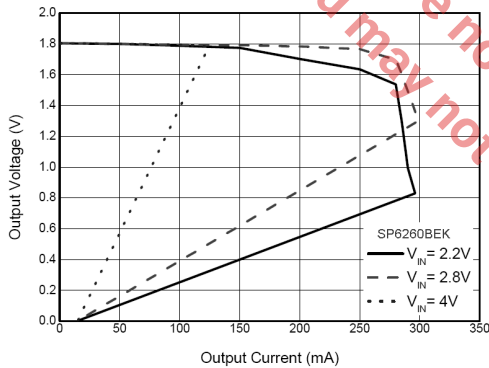

Fig. 6: Output Voltage vs. Output Current SP6260BEK (1.8V)

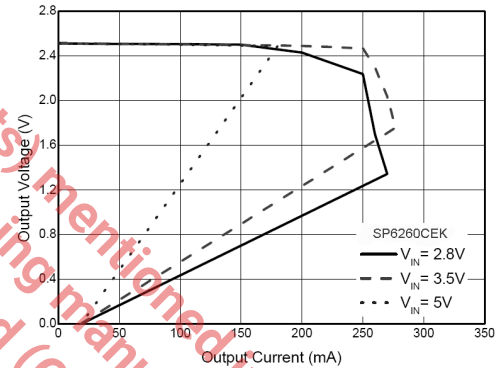

Fig. 7: Output Voltage vs. Output Current SP6260CEK (2.5V)

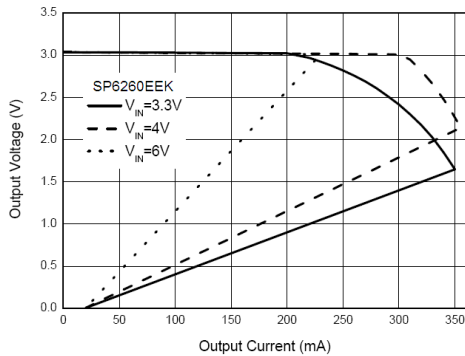

Fig. 8: Output Voltage vs. Output Current SP6260EEK (3.0V)



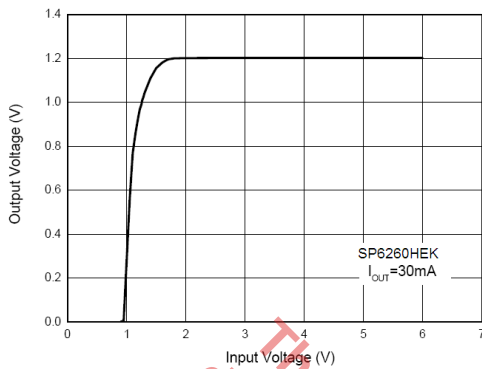

Fig. 9: Output Voltage vs. Input Voltage  
SP6260HEK (1.2V)

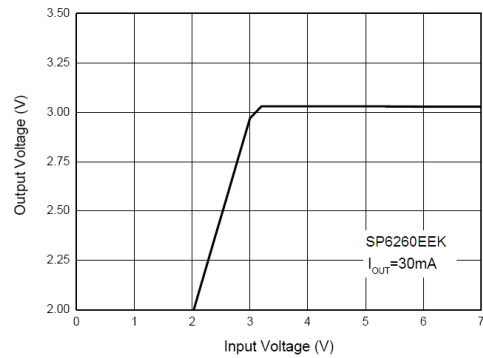

Fig. 10: Output Voltage vs. Input Voltage  
SP6260EEK (3.0V)

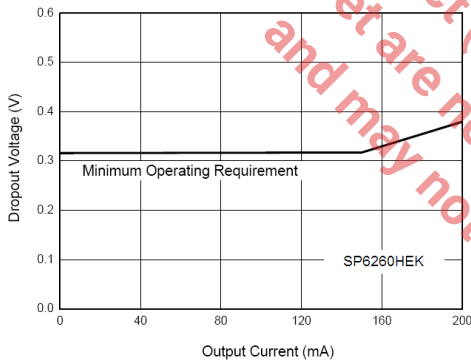

Fig. 11: Dropout Voltage vs. Output Current  
SP6260HEK-L (1.2V)

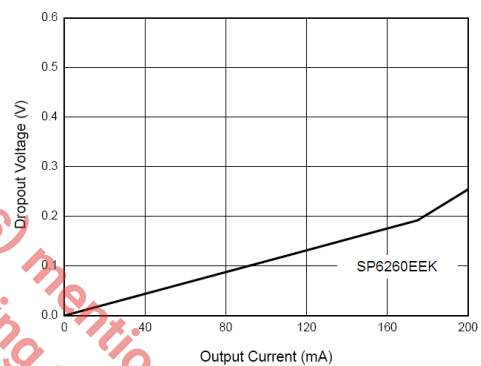

Fig. 12: Dropout Voltage vs. Output Current  
SP6260EEK-L (3.0V)

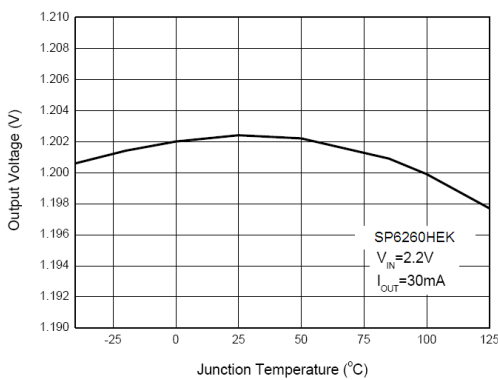

Fig. 13: Output Voltage vs. Junction Temperature  
SP6260HEK-L (1.2V)

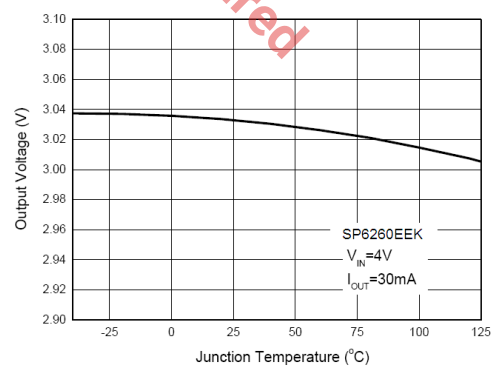

Fig. 14: Output Voltage vs. Junction Temperature  
SP6260EEK-L (3.0V)

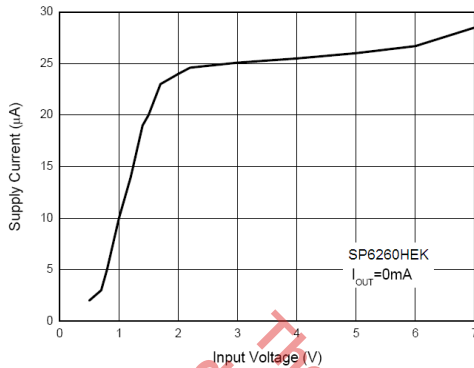

Fig. 15: Supply Current vs. Input Voltage SP6260HEK (1.2V)

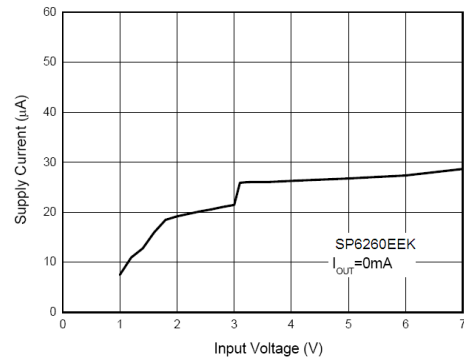

Fig. 16: Supply Current vs. Input Voltage SP6260EEK (3.0V)

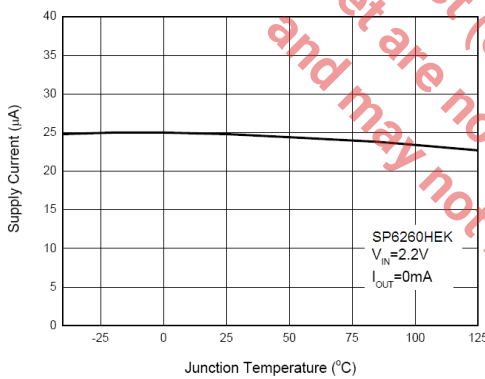

Fig. 17: Supply Current vs. Junction Temperature SP6260HEK (1.2V)

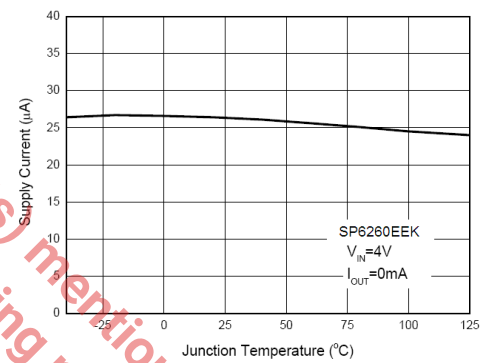

Fig. 18: Supply Current vs. Junction Temperature SP6260EEK (3.0V)

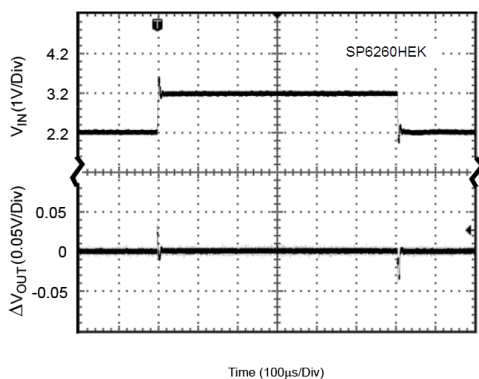

Fig. 19: Line Transient SP6260HEK (1.2V)  
(Conditions:  $I_{OUT}=30mA$ ,  $C_{IN}=1\mu F$ ,  $C_{OUT}=1\mu F$ )

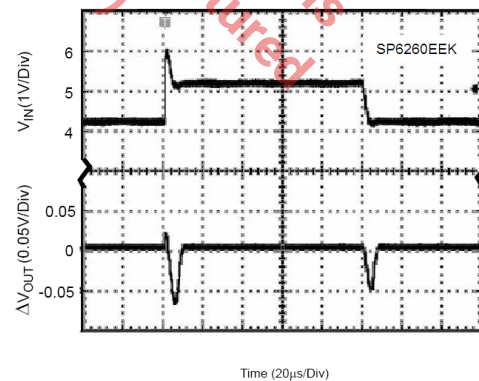

Fig. 20: Line Transient SP6260EEK (3.0V)  
(Conditions:  $I_{OUT}=30mA$ ,  $C_{IN}=1\mu F$ ,  $C_{OUT}=1\mu F$ )

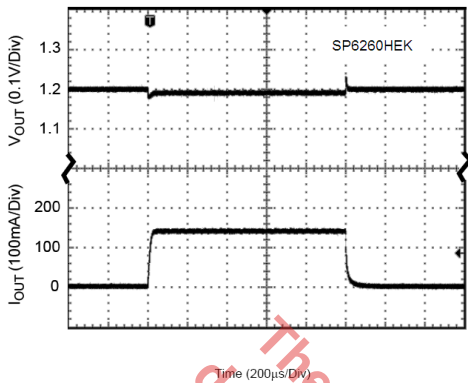

Fig. 21: Line Transient SP6260HEK (1.2V)  
 (Conditions:  $V_{IN}=2.5V$ ,  $C_{IN}=1\mu F$ ,  $C_{OUT}=1\mu F$ )

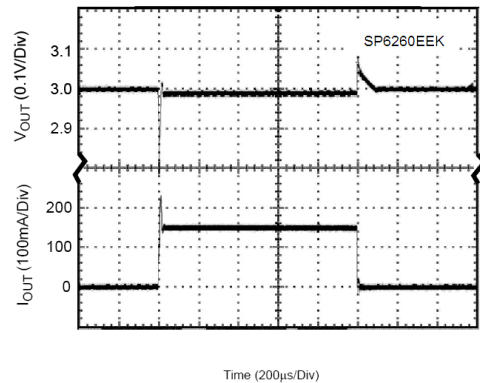

Fig. 22: Line Transient SP6260EEK (3.0V)  
 (Conditions:  $V_{IN}=4V$ ,  $C_{IN}=1\mu F$ ,  $C_{OUT}=1\mu F$ )

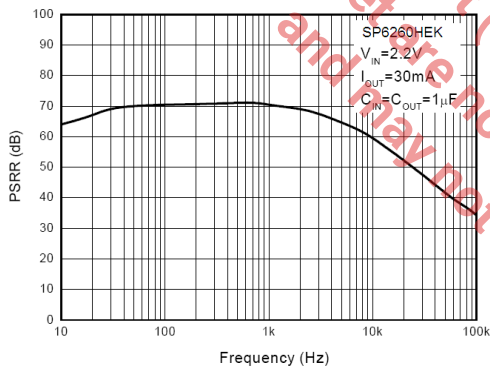

Fig. 23: PSRR vs. Frequency  
 SP6260HEK (1.2V)

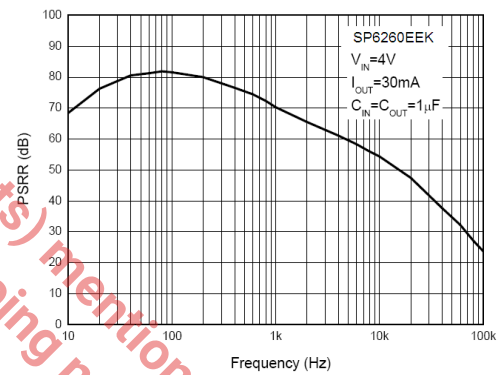
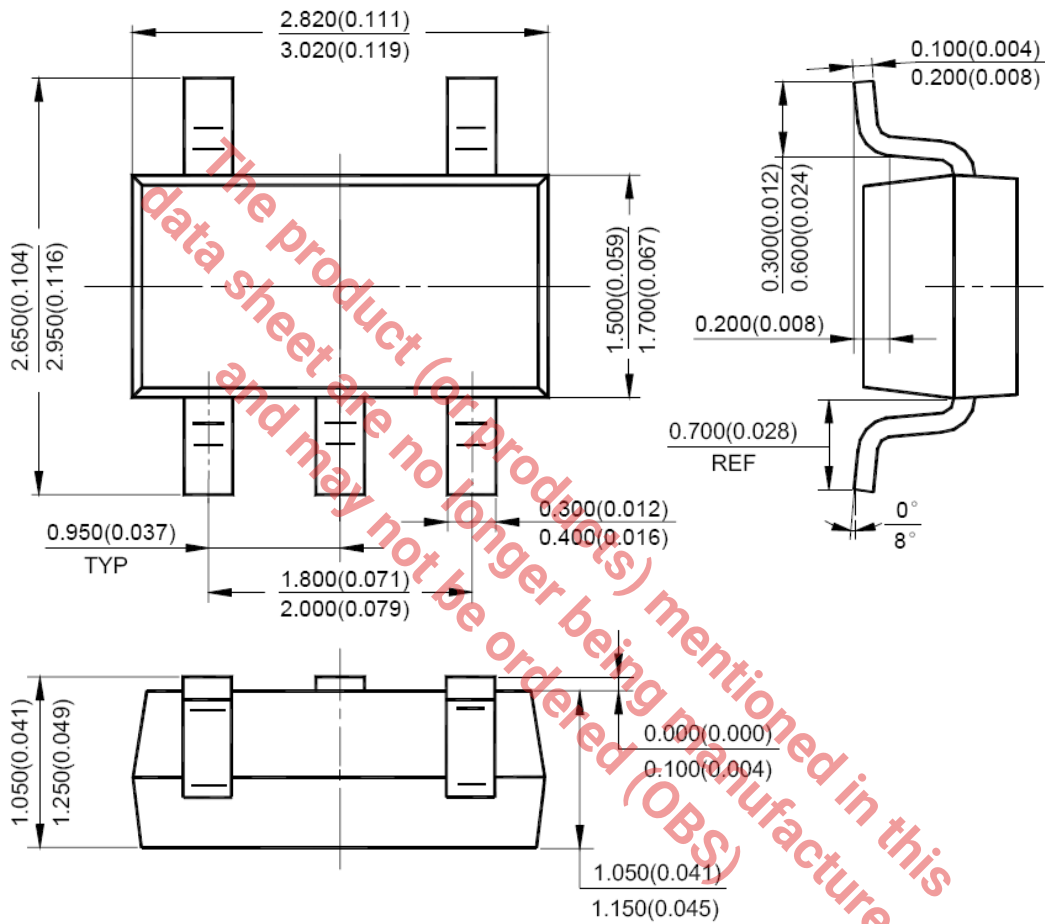

Fig. 21: PSRR vs. Frequency  
 SP6260EEK (3.0V)

**PACKAGE SPECIFICATION**

**5-PIN SOT-23**

Unit: mm (inch)



**REVISION HISTORY**

Revision	Date	Description
0.1		Initial Data Sheet
2.0.0	10/27/2010	Reformat of datasheet Increased output current capabilities to 200mA Removal of 1.5V version curves Addition of the 1.2V version data and curves
2.1.0	01/26/2011	Corrected Electrical tables $V_{OUT}$ range for SP6260E, SP6260F and SP6260G Addition of "Output Current vs Output Voltage" curves figures 5, 6 and 7.
2.1.1	01/24/20	Updated to MaxLinear logo. Updated Ordering Information.

**CORPORATE HEADQUARTERS:**

5966 La Place Court

Suite 100

Carlsbad, CA 92008

Tel.: +1 (760) 692-0711

Fax: +1 (760) 444-8598

[www.maxlinear.com](http://www.maxlinear.com)

The content of this document is furnished for informational use only, is subject to change without notice, and should not be construed as a commitment by Maxlinear, Inc. Maxlinear, Inc. Assumes no responsibility or liability for any errors or inaccuracies that may appear in the informational content contained in this guide. Complying with all applicable copyright laws is the responsibility of the user. Without limiting the rights under copyright, no part of this document may be reproduced into, stored in, or introduced into a retrieval system, or transmitted in any form or by any means (electronic, mechanical, photocopying, recording, or otherwise), or for any purpose, without the express written permission of Maxlinear, Inc.

Maxlinear, Inc. Does not recommend the use of any of its products in life support applications where the failure or malfunction of the product can reasonably be expected to cause failure of the life support system or to significantly affect its safety or effectiveness. Products are not authorized for use in such applications unless Maxlinear, Inc. Receives, in writing, assurances to its satisfaction that: (a) the risk of injury or damage has been minimized; (b) the user assumes all such risks; (c) potential liability of Maxlinear, Inc. Is adequately protected under the circumstances.

Maxlinear, Inc. May have patents, patent applications, trademarks, copyrights, or other intellectual property rights covering subject matter in this document. Except as expressly provided in any written license agreement from Maxlinear, Inc., the furnishing of this document does not give you any license to these patents, trademarks, copyrights, or other intellectual property.

Maxlinear, the Maxlinear logo, and any Maxlinear trademarks, MxL, Full-Spectrum Capture, FSC, G.now, AirPHY and the Maxlinear logo are all on the products sold, are all trademarks of Maxlinear, Inc. or one of Maxlinear's subsidiaries in the U.S.A. and other countries. All rights reserved. Other company trademarks and product names appearing herein are the property of their respective owners.

© 2010 - 2020 Maxlinear, Inc. All rights reserved.

# Mouser Electronics

Authorized Distributor

Click to View Pricing, Inventory, Delivery & Lifecycle Information:

[MaxLinear:](#)

[SP6260DEK-L/TR](#) [SP6260BEK-L/TR](#) [SP6260CEK-L/TR](#) [SP6260EEK-L/TR](#) [SP6260FEK-L/TR](#) [SP6260GEK-L/TR](#)