



LIGHTING FOREVER

8 PIN SOP PHOTOTRANSISTOR PHOTOCOUPLER

EL20X / 21X series

Features

- Current transfer ratios in offered in narrow ranges
 - EL205: 40-80%
 - EL206: 63-125%
 - EL207: 100-200%
 - EL208: 160-320%
 - EL211: >20%
 - EL212: >50%
 - EL213: >100%
- High isolation voltage between input and output
Viso = 3750 Vrms
- Operating temperature range of -55 to +110°C
- High BVceo of 80V
- Standard SO-8 footprint package
- Pb free and RoHS compliant.
- UL approved (No. E214129)
- VDE approval (pending)
- SEMKO approved
- NEMKO approved
- DEMKO approved
- FIMKO approved
- CSA approved (No. 2007189)

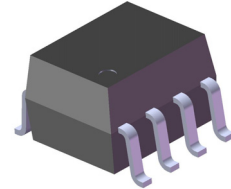

Schematic

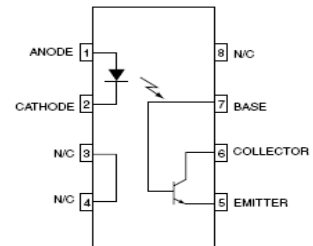

1. Anode
2. Cathode
3. No Connection
4. No Connection
5. Emitter
6. Collector
7. Base
8. No Connection

Description

The EL20X and EL21X series contain an infrared emitting diode optically coupled to a phototransistor detector. The devices are packaged in an 8-pin small outline package which conforms to the standard SO-8 footprint.

Applications

- Feedback Control Circuits
- Interfacing and coupling systems of different potentials and impedances
- General Purpose Switching Circuits
- Monitor and Detection Circuits



LIGHTING FOREVER

8 PIN SOP PHOTOTRANSISTOR PHOTOCOUPLER

EL20X / 21X series

Absolute Maximum Ratings ($T_a=25^{\circ}\text{C}$)

Parameter		Symbol	Rating	Unit
Input	Forward current	I_F	60	mA
	Peak forward current ($t = 10\mu\text{s}$)	I_{FM}	1	A
	Reverse voltage	V_R	6	V
	Power dissipation No Derating needed	P_D	90	mW
Output	Collector power dissipation No derating needed	P_C	150	mW
	Collector-Emitter voltage	V_{CEO}	80	V
	Collector-Base voltage	V_{CBO}	80	V
	Emitter-Collector voltage	V_{ECO}	7	V
Total power dissipation		P_{tot}	240	mW
Isolation voltage ^{*1}		V_{iso}	3750	Vrms
Operating temperature		T_{opr}	-55~+110	$^{\circ}\text{C}$
Storage temperature		T_{stg}	-55~+150	$^{\circ}\text{C}$
Soldering temperature ^{*2}		T_{sol}	260	$^{\circ}\text{C}$

Notes

*1 AC for 1 minute, R.H.= 40 ~ 60% R.H. In this test, pins 1, 2 & 3 are shorted together, and pins 4, 5 & 6 are shorted together.

*2 For 10 seconds.



LIGHTING FOREVER

8 PIN SOP PHOTOTRANSISTOR PHOTOCOUPLER

EL20X / 21X series

Electrical Characteristics (T_a=25°C unless specified otherwise)

Input

Parameter	Symbol	Min.	Typ.*	Max.	Unit	Condition
Forward voltage	V _F	-	1.3	1.5	V	I _F = 10mA
Reverse current	I _R	-	0.1	100	μA	V _R = 6V
Input capacitance	C _{in}	-	13	-	pF	V = 0, f = 1MHz

Output

Parameter	Symbol	Min.	Typ.*	Max.	Unit	Condition
Collector-Emitter dark current	I _{CEO}	-	5.0	50	nA	V _{CE} = 10V, I _F = 0mA
Collector-Emitter breakdown voltage	BV _{CEO}	80	-	-	V	I _C = 0.1mA
Emitter-Collector breakdown voltage	BV _{ECO}	7	-	-	V	I _E = 0.1mA
Collector-Emitter capacitance	C _{CE}	-	8	-	pF	VCE = 0V, f = 1MHz

Transfer Characteristics

Parameter	Symbol	Min.	Typ.*	Max.	Unit	Condition
Current Transfer Ratio	EL205	40	-	80	%	I _F = 10mA, V _{CE} = 5V
	EL206	63	-	125		
	EL207	100	-	200		
	EL208	160	-	320		
	EL211	20	-	-		
	EL212	50	-	-		
	EL213	100	-	-		
Current Transfer Ratio	EL205	13	25	-	%	I _F = 1mA, V _{CE} = 5V
	EL206	22	40	-		
	EL207	34	60	-		
	EL208	56	95	-		
	EL215	20	50	-		
	EL216	50	80	-		
	EL217	100	130	-		
Collector-emitter saturation voltage	V _{CE(sat)}	-	-	0.4	V	I _F = 10mA, I _C = 2mA
Isolation resistance	R _{IO}	-	10 ¹¹	-	Ω	V _{IO} = 500Vdc
Input-output capacitance	C _{IO}	-	0.5	-	pF	V _{IO} = 0, f = 1MHz



LIGHTING FOREVER

8 PIN SOP PHOTOTRANSISTOR PHOTOCOUPLER

EL20X / 21X series

Transfer Characteristics (Continue)

Turn-on time	T_{on}	-	3.0	-	μs	$V_{CC} = 10V,$ $I_C = 2mA, R_L = 100\Omega$
Turn-off time	T_{off}	-	3.0	-		
Rise time	T_r	-	1.6	-		
Fall time	T_f	-	2.2	-		

* Typical values at $T_a = 25^\circ C$

8 PIN SOP PHOTOTRANSISTOR PHOTOCOUPLER

EL20X / 21X series

Typical Performance Curves

Figure 1. Forward Current vs Forward Voltage

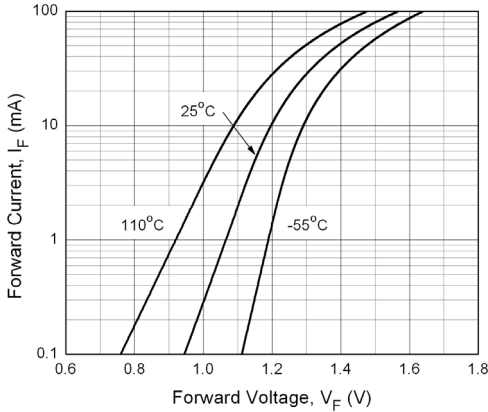

Figure 2. Normalized Collector Current vs. Forward Current

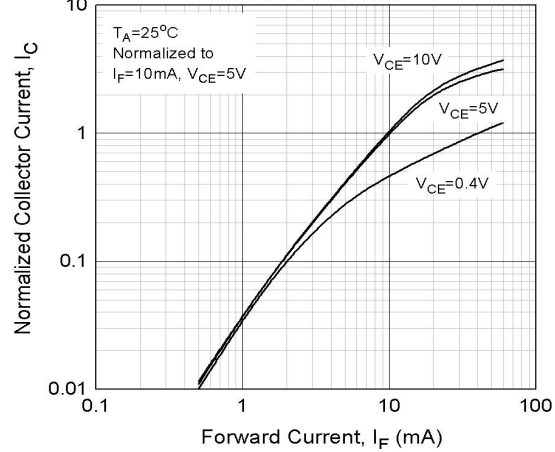

Figure 3. Normalized Collector Current vs Ambient Temperature

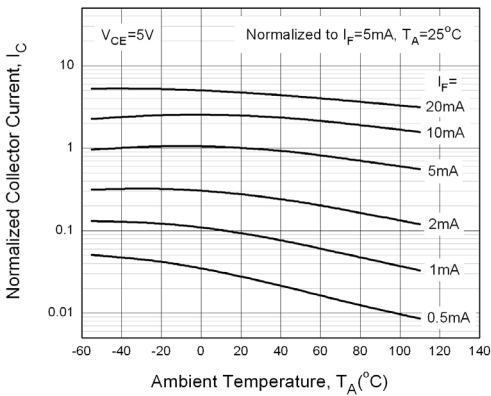

Figure 4. Collector Dark Current vs Ambient Temperature

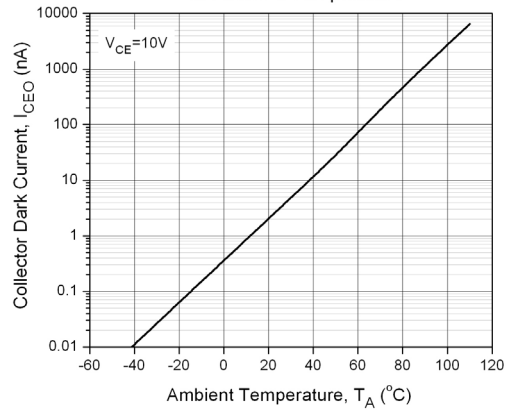

Figure 5. Collector Current vs Collector-Emitter Voltage

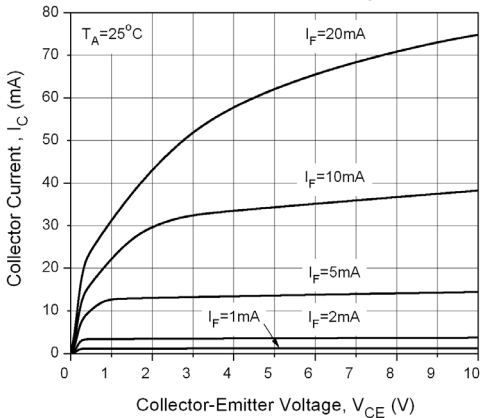
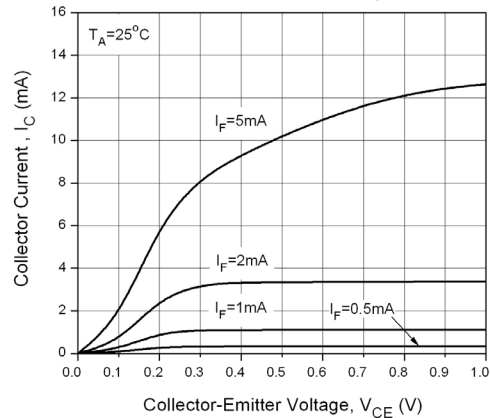

Figure 6. Collector Current vs Collector-Emitter Voltage



8 PIN SOP PHOTOTRANSISTOR PHOTOCOUPLER

EL20X / 21X series

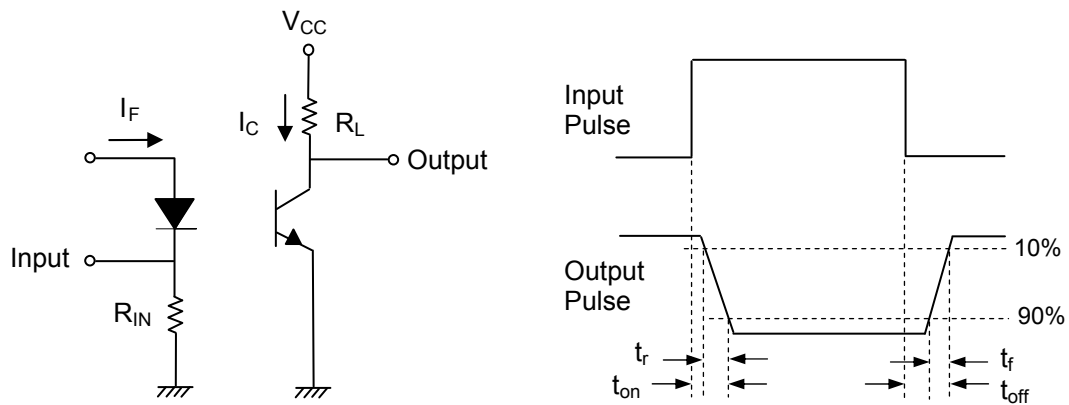
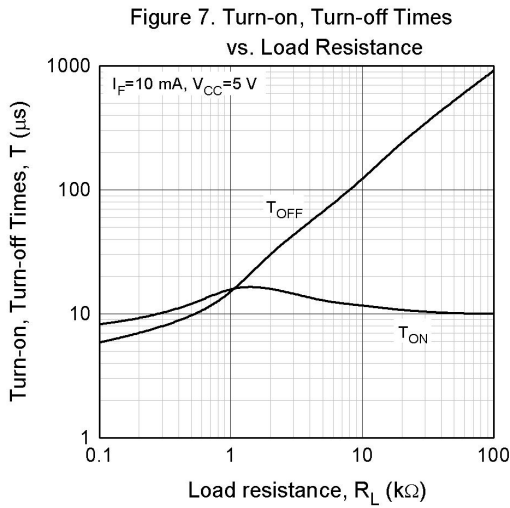

Figure 8. Switching Time Test Circuit & Waveforms



LIGHTING FOREVER

8 PIN SOP PHOTOTRANSISTOR PHOTOCOUPLER

EL20X / 21X series

Order Information

Part Number

EL2XX(Y)-V

Note

XX = Part no. (05, 06, 07, 08, 11, 12, 13, 15, 16 or 17)

Y = Tape and reel option (TA, TB or none).

V = VDE safety (Optional)

Option	Description	Packing quantity
None	Standard	100 units per tube
-V	Standard + VDE	100 units per tube
(TA)	TA tape & reel option	2000 units per reel
(TB)	TB tape & reel option	2000 units per reel
(TA)-V	TA tape & reel option + VDE	2000 units per reel
(TB)-V	TB tape & reel option + VDE	2000 units per reel



LIGHTING FOREVER

8 PIN SOP PHOTOTRANSISTOR PHOTOCOUPLER

EL20X / 21X series

Package Drawings (Dimensions in mm)

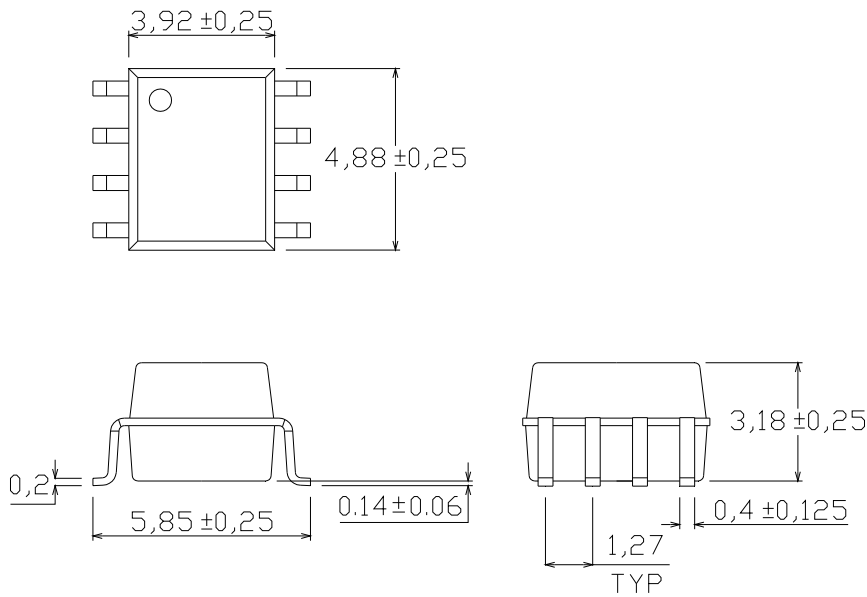

Recommended pad layout for surface mount leadform

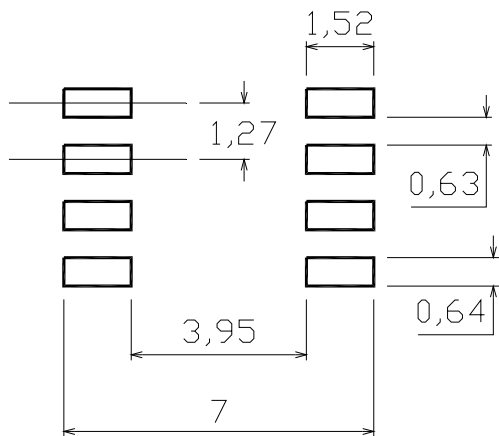



LIGHTING FOREVER

8 PIN SOP PHOTOTRANSISTOR PHOTOCOUPLER

EL20X / 21X series

Device Marking

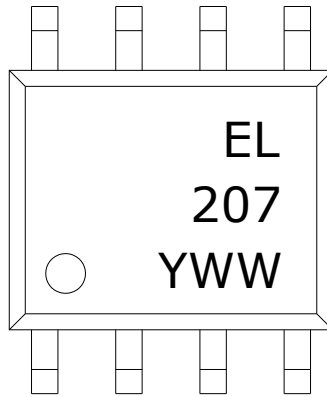

Notes

EL denotes Everlight
207 denotes Part Number
Y denotes 1 digit Year code
WW denotes 2 digit Week code



LIGHTING FOREVER

8 PIN SOP PHOTOTRANSISTOR PHOTOCOUPLER

EL20X / 21X series

Tape & Reel Packing Specifications

Option TA

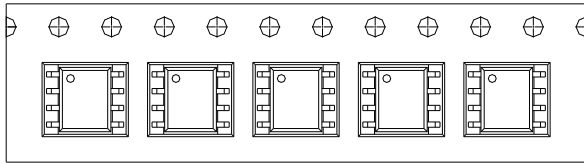

Option TB

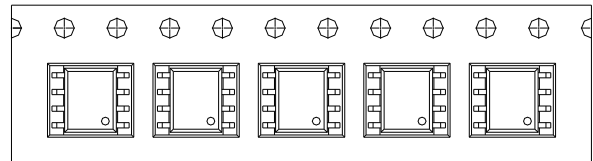

Direction of feed from reel



Direction of feed from reel

Tape dimensions

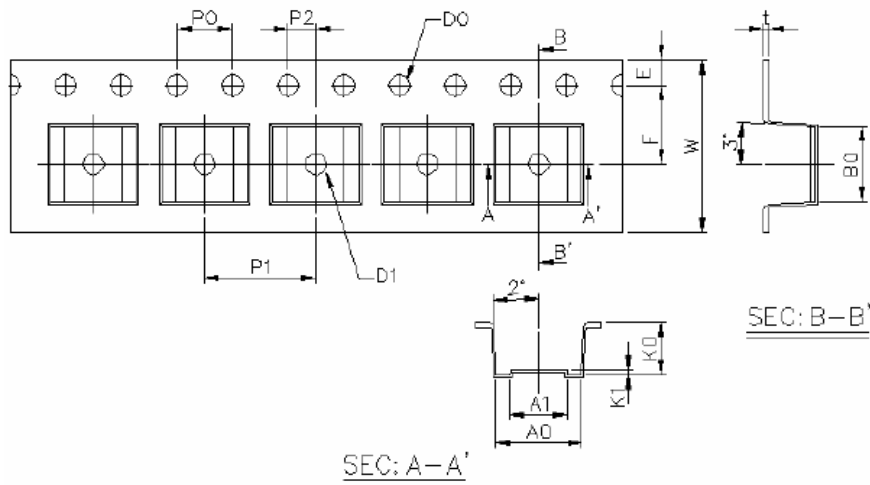

Dimension No.	A0	A1	B0	D0	D1	E	F
Dimension(mm)	6.2±0.1	4.1±0.1	5.28±0.1	1.5±0.1	1.5±0.3	1.75±0.1	5.5±0.1
Dimension No.	Po	P1	P2	t	W	K0	K1
Dimension(mm)	4.0±0.1	8.0±0.1	2.0±0.1	0.4±0.1	12.0+0.3/ -0.1	3.7±0.1	0.3±0.1



LIGHTING FOREVER

8 PIN SOP PHOTOTRANSISTOR PHOTOCOUPLER

EL20X / 21X series

Solder Reflow Temperature Profile

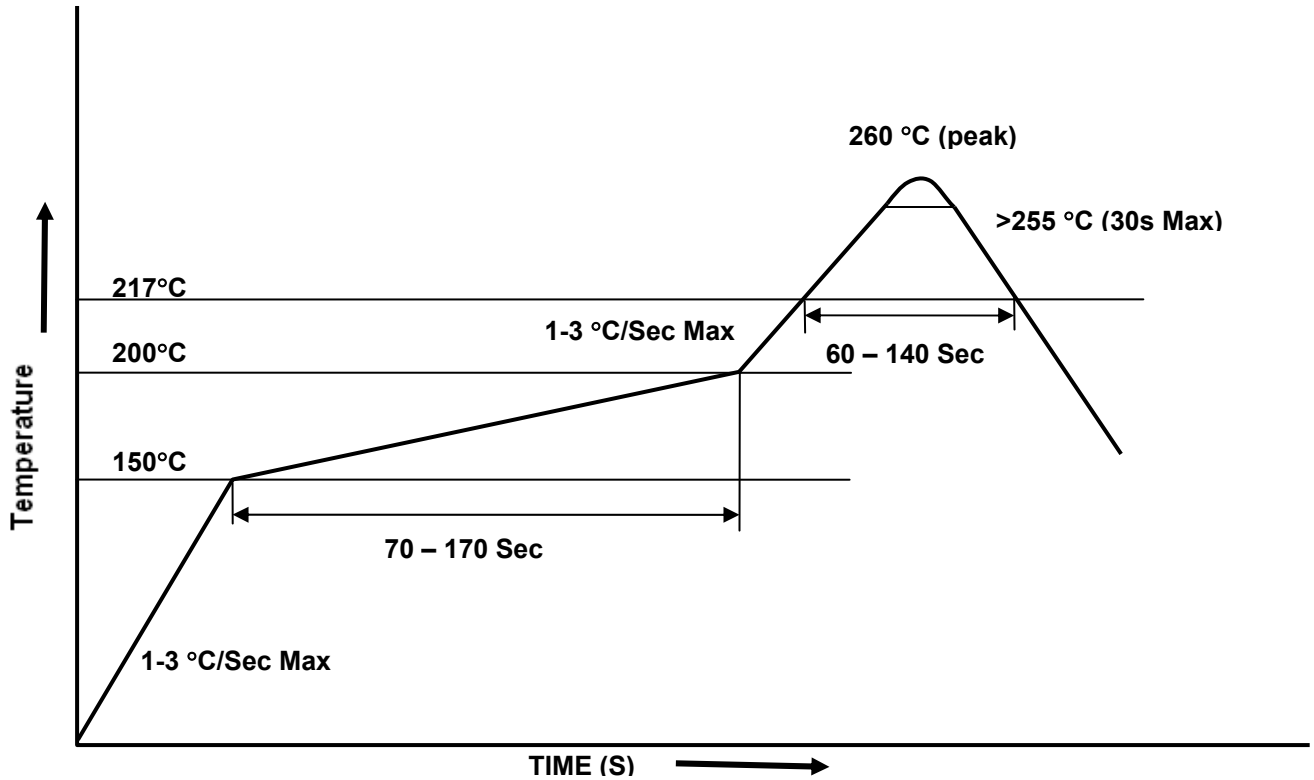



LIGHTING FOREVER

8 PIN SOP PHOTOTRANSISTOR PHOTOCOUPLER

EL20X / 21X series

DISCLAIMER

1. The specifications in this datasheet may be changed without notice. EVERLIGHT reserves the authority on material change for above specification.
2. When using this product, please observe the absolute maximum ratings and the instructions for use as outlined in this datasheet. EVERLIGHT assumes no responsibility for any damage resulting from use of the product which does not comply with the absolute maximum ratings and the instructions included in this datasheet.
3. These specification sheets include materials protected under copyright of EVERLIGHT. Reproduction in any form is prohibited without the specific consent of EVERLIGHT.

Mouser Electronics

Authorized Distributor

Click to View Pricing, Inventory, Delivery & Lifecycle Information:

Everlight:

[EL205](#) [EL205\(TA\)](#) [EL205\(TA\)-V](#) [EL205\(TB\)](#) [EL205\(TB\)-V](#) [EL205-V](#) [EL206](#) [EL206\(TA\)](#) [EL206\(TA\)-V](#) [EL206\(TB\)](#) [EL206\(TB\)-V](#) [EL206-V](#) [EL207](#) [EL207\(TA\)-V](#) [EL207\(TB\)](#) [EL207\(TB\)-V](#) [EL207-V](#) [EL208](#) [EL208\(TA\)](#) [EL208\(TA\)-V](#) [EL208\(TB\)](#) [EL208\(TB\)-V](#) [EL208-V](#) [EL211](#) [EL211\(TA\)](#) [EL211\(TA\)-V](#) [EL211\(TB\)](#) [EL211\(TB\)-V](#) [EL211-V](#) [EL212](#) [EL212\(TA\)](#) [EL212\(TA\)-V](#) [EL212\(TB\)](#) [EL212\(TB\)-V](#) [EL212-V](#) [EL213](#) [EL213\(TA\)](#) [EL213\(TA\)-V](#) [EL213\(TB\)](#) [EL213\(TB\)-V](#) [EL213-V](#) [EL215](#) [EL215\(TA\)](#) [EL215\(TA\)-V](#) [EL215\(TB\)](#) [EL215\(TB\)-V](#) [EL215-V](#) [EL216](#) [EL216\(TA\)](#) [EL216\(TA\)-V](#) [EL216\(TB\)](#) [EL216\(TB\)-V](#) [EL216-V](#) [EL217](#) [EL217\(TA\)](#) [EL217\(TA\)-V](#) [EL217\(TB\)](#) [EL217\(TB\)-V](#) [EL217-V](#)