

TL6110 SERIES TACT SWITCH

ANTI-VANDAL SWITCHES
 DETECTOR SWITCHES
 DIP SWITCHES
 KEYLOCK SWITCHES
 NAVIGATION SWITCHES
 PUSHBUTTON SWITCHES
 ROCKER SWITCHES
 ROTARY SWITCHES
 SLIDE SWITCHES
 SNAP ACTION SWITCHES
TACTILE SWITCHES
 TOGGLE SWITCHES
 CAP OPTIONS

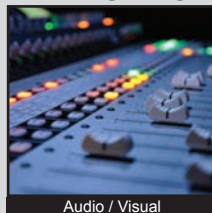

APPLICATIONS / MARKETS



Audio / Visual

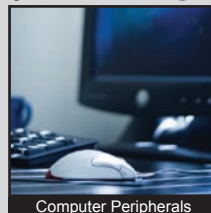

Computer Peripherals



Consumer Electronics

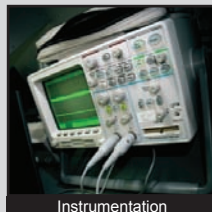

Instrumentation



Telecommunication

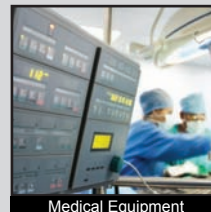

Medical Equipment

RoHS

SPECIFICATIONS

Electrical Rating: 50mA @ 12VDC
Life Expectancy: per chart
Contact Resistance: 100mΩ Max. Initial
Insulation Resistance: 100 MΩ Min. at 100VAC
Dielectric Strength: 250VAC for 1 min.
Operating Temperature: -40°C to 85°C
Storage Temperature: -40°C to 85°C
Operating Force: 130 gf, 160 gf, 300 gf, 500 gf
Travel: 0.50mm
Contact Arrangement: SPST

FEATURES & BENEFITS

- Tube packaging
- Multiple operating forces
- Gold or silver contact option
- Multiple actuator lengths
- Process sealed

PART NUMBER CONFIGURATOR

Series	Actuator Options	Actuation Force	Contact Plating	Termination
<input type="checkbox"/> <input type="checkbox"/> <input type="checkbox"/> <input type="checkbox"/> <input type="checkbox"/> <input type="checkbox"/>	<input type="checkbox"/>	<input type="checkbox"/> <input type="checkbox"/> <input type="checkbox"/> <input type="checkbox"/>	<input type="checkbox"/>	<input type="checkbox"/>
TL6110 - right angle	A - 3.50mm B - 4.00mm C - 5.70mm D - 8.80mm	F130 - 130 gf F160 - 160 gf F300 - 300 gf F500 - 500 gf	Q - Silver R - Gold	P - PCB Pins

Actuation Force	Life Cycles
130 gf	1,000,000
160 gf	1,000,000
300 gf	500,000
500 gf	200,000

Specifications subject to change without notice



E-SWITCH®

www.e-switch.com

800.867.2717

2

TL6110 SERIES TACT SWITCH

BODY DIMENSIONS

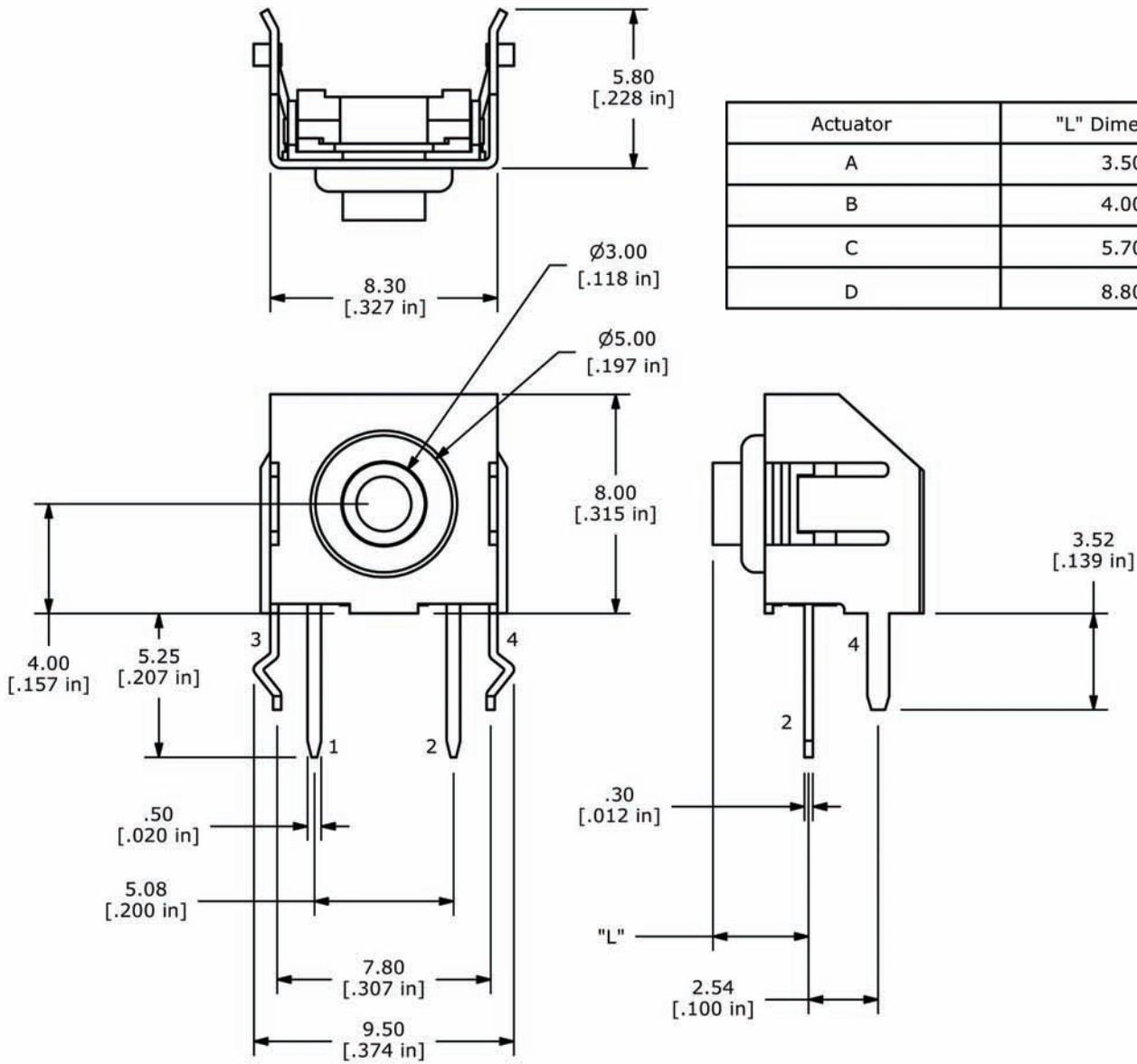

Actuator	"L" Dimension
A	3.50
B	4.00
C	5.70
D	8.80

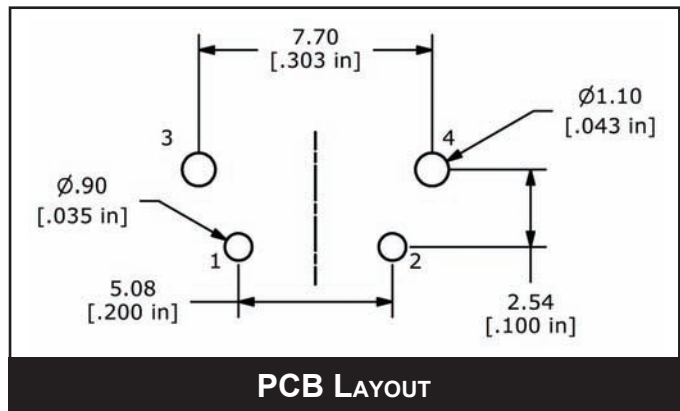
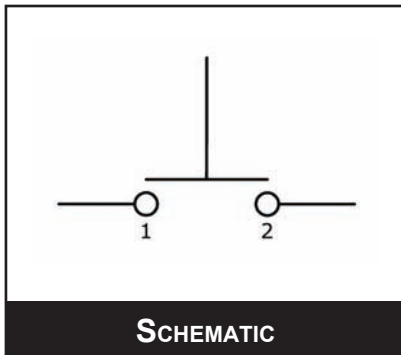

Mouser Electronics

Authorized Distributor

Click to View Pricing, Inventory, Delivery & Lifecycle Information:

E-Switch:

[TL6110AF160RP](#) [TL6110BF160QP](#) [TL6110CF500QPSSDOME](#) [TL6110DF300QP](#) [TL6110BF130QP](#)
[TL6110AF130QP](#) [TL6110AF160QP](#) [TL6110CF160QP](#) [TL6110BF300QP](#) [TL6110DF160QP](#) [TL6110AF300QP](#)
[TL6110AF500QP](#) [TL6110BF300RP](#) [TL6110BF500QP](#) [TL6110CF300QP](#) [TL6110CF500QP](#) [TL6110DF130QP](#)
[TL6110DF160RP](#) [TL6110CF160RP](#) [TL6110AF300RP](#)