

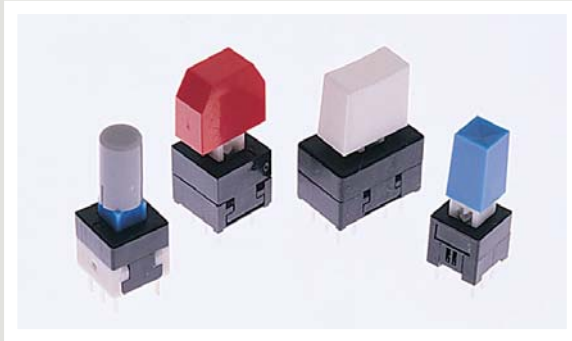

# SERIES TL 2201 SWITCHES

## PUSHBUTTON SWITCHES - SUB MINIATURE



### SPECIFICATIONS

Contact Rating:	100mA@30 VDC
Life Expectancy:	10,000 cycles
Contact Resistance:	100mΩ max.
Insulation Resistance:	100MΩ min.
Dielectric Strength:	500 VAC
Actuation Force:	See individual model
Travel:	See individual model

### MATERIALS

Housing:	PBT
Actuator:	Acetal
Cover:	Acetal
Contacts:	Silver plated phosphor bronze
Terminals:	Silver plated copper alloy
Spring:	Stainless steel
Latching Pin:	Stainless steel

### FEATURES & BENEFITS

- ▶ Momentary & latching designs
- ▶ Long travel

### APPLICATIONS/MARKETS

- ▶ Telecommunications
- ▶ Networking
- ▶ Computers/servers
- ▶ Performance audio
- ▶ Instrumentation
- ▶ Low power on/off designs
- ▶ External hard drives and modems



### HOW TO ORDER

SERIES	MODEL NO.	MECHANICAL CONFIGURATION	ACTUATOR ("L" Dimension)	TERMINATION	CAP (Where Avail.)	CAP COLOR
TL	2230 2285	EE = Latching OA = Momentary	(None) = Std.	(None) = Std.	See Cap Section	
TL	2201 = DPDT 4201 = 4PDT	EE = Latching OA = Momentary	X Y Z	A B	See Cap Section	
	2202* 2203	EE = Latching OA = Momentary				



### Example Ordering Number

TL-2201-EE-Y-B-.09-BLK

\*Note: TL 2202 is an MBB (shorting) version.

Specifications subject to change without notice.

## TL 2230

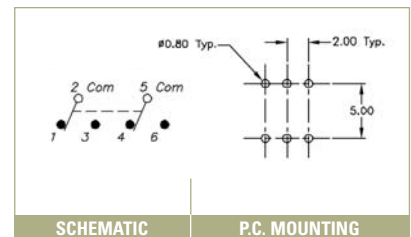
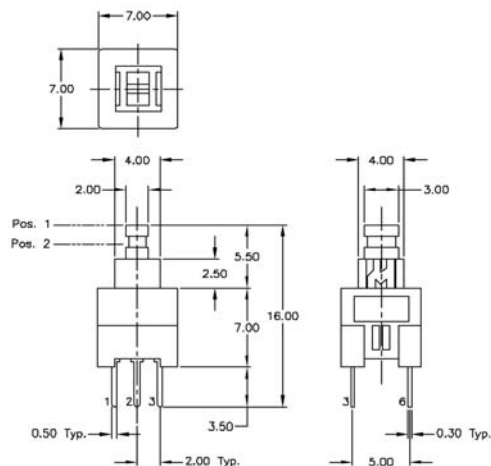



# SERIES TL 2201 SWITCHES

## PUSHBUTTON SWITCHES - SUB MINIATURE

TACT SWITCHES

NAVIGATION SWITCHES

PUSHBUTTON SWITCHES

TOGGLE SWITCHES

ROCKER SWITCHES

SLIDE SWITCHES

SNAP-ACTION SWITCHES

DIP SWITCHES

KEYLOCK SWITCHES

ROTARY SWITCHES

DETECTOR SWITCHES

CAP OPTIONS

### TL 2285



SCHEMATIC

P.C. MOUNTING

### TL 2201

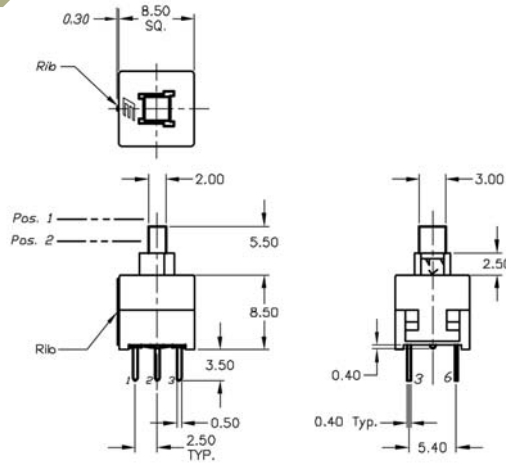

SCHEMATIC

P.C. MOUNTING

### TL 4201



SCHEMATIC

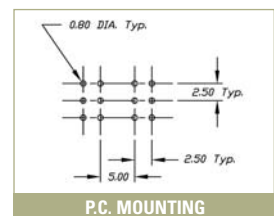

P.C. MOUNTING

## TL 2202

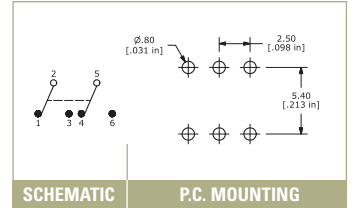

## TL 2203



### ACTUATOR OPTIONS – TL 2201 & TL 4201

**X**



See Cap Section

**Y**



See Cap Section

**Z**



See Cap Section

### TERMINATION OPTIONS – TL 2201 & TL 4201

**A**



**B**

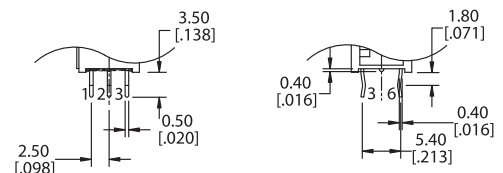

# Mouser Electronics

Authorized Distributor

Click to View Pricing, Inventory, Delivery & Lifecycle Information:

## E-Switch:

[TL2230EEF100](#) [TL2201EEZB](#) [TL2201EEYA](#) [TL2201OAYA](#) [TL2230OAF140](#) [TL2201EEZA](#) [TL2285OA](#) [TL2285EE](#)  
[TL2201OAZA](#) [TL2230EEF140](#) [TL2201EEYB](#) [TL2201EEYB5JWHT](#) [TL2201EEZA1RBLK](#) [TL2201EEZB1CBLK](#)  
[TL2201OAXA](#) [TL2201OAXB](#) [TL2201OAYB](#) [TL2201OAZA1DRED](#) [TL2201OAZB](#) [TL2201EEXA](#) [TL2201EEXB](#)  
[TL2201EEYB.094GRY](#) [TL2201OAZA1RDGR](#) [TL2201OAZB1CRED](#) [TL2230OAF1401CBLK](#) [TL2230OAF100](#)  
[TL2230OAF1401DBLK](#) [TL2230EEF230](#)