



CRYSTAL OSCILLATOR (SPXO)

OUTPUT : CMOS, TTL

SG-615 series SG-531 / SG-51 series

- Frequency range : 1.025 MHz to 135 MHz
- Supply voltage : 3.3 V Typ. / 5.0 V Typ.
- Function : Output enable(OE) or Standby(\overline{ST})
- Pin compatible with full-size metal can. (SG-51 series)
- Pin compatible with half-size metal can. (SG-531 series)



Product Number (please contact us)

SG-615 : Q33615xx2xxxx00

SG-531 : Q32531xx2xxxx00

SG-51 : Q32510xx2xxxx00



Actual size

SG-615

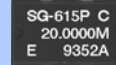

SG-531



SG-51

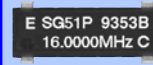

Specifications (characteristics)

Item	Symbol	Specifications		Conditions / Remarks
		SG-615P SG-531P SG-51P	SG-615PTJ SG-531PTJ SG-51PTJ	
Output frequency range	f_o	1.025 MHz to 26 MHz	26.001 MHz to 66.667 MHz	Please contact us about available frequencies.
Supply voltage	V_{cc}	5.0 V ± 0.5 V		
Storage temperature	T_{stg}	-55 °C to +125 °C		Storage as single product.
Operating temperature	T_{use}	-20 °C to +70 °C		
Frequency tolerance	f_{tol}	B ¹ : $\pm 50 \times 10^{-6}$, C: $\pm 100 \times 10^{-6}$		-20 °C to +70 °C
Current consumption	I_{cc}	23 mA Max.	35 mA Max.	No load condition
Disable current	I_{dis}	12 mA Max.	28 mA Max.	OE=GND
Symmetry	SYM	40 % to 60 %	—	CMOS load:50 % V_{cc} level
		40 % to 60 %	45 % to 55 %	TTL load: 1.4 V level
Output voltage	V_{OH}	$V_{cc}-0.4$ V Min.	2.4 V Min.	$I_{OH}=-400 \mu A$
	V_{OL}	0.4 V Max.		$I_{OL}=16$ mA(P)/ 8 mA(PTJ)
Output load condition (TTL)	L_{TTL}	10 TTL Max.	5 TTL Max.	$L_{CMOS} \leq 15$ pF
Output load condition (CMOS)	L_{CMOS}	50 pF Max.	—	
Input voltage	V_{IH}	2.0 V Min.	3.5 V Min.	$I_{IH}=1 \mu A$ Max. (OE= V_{cc})
	V_{IL}	0.8 V Max.	1.5 V Max.	$I_{IL}=-100 \mu A$ Min. (OE=GND), PTJ: $I_{IL}=-500 \mu A$ Min.(OE=GND)
Rise time / Fall time	t_r / t_f	8 ns Max.	—	CMOS load:20 % V_{cc} to 80 % V_{cc} level
		8 ns Max.	5 ns Max.	TTL load:0.4 V to 2.4 V level
Start-up time	t_{str}	4 ms Max.	10 ms Max.	Time at minimum supply voltage to be 0 s
Frequency aging	f_{aging}	$\pm 5 \times 10^{-6}$ / year Max.		+25 °C, $V_{cc}=5.0$ V, First year

*1 "B" tolerance will be available up to 55 MHz.

Specifications (characteristics)

Item	Symbol	Specifications			Conditions / Remarks
		SG-615PCG SG-531PCG	SG-615SCG SG-531SCG	SG-615PCN	
Output frequency range	f_o	1.500 MHz to 26.000 MHz		26.001 MHz to 66.667 MHz	Please contact us about available frequencies.
Supply voltage	V_{cc}	2.7 V to 3.6 V			
Storage temperature	T_{stg}	-55 °C to +125 °C			Storage as single product.
Operating temperature	T_{use}	-40 °C to +85 °C			
Frequency tolerance	f_{tol}	B: $\pm 50 \times 10^{-6}$ C: $\pm 100 \times 10^{-6}$ M: $\pm 100 \times 10^{-6}$			-20 °C to +70 °C -40 °C to +85 °C
Current consumption	I_{cc}	12 mA Max.		20 mA Max.	No load condition
Disable current	I_{dis}	10 mA Max.	—	10 mA Max.	OE=GND (PCG,PCN)
Stand-by current	I_{std}	—	50 μA Max.	—	\overline{ST} =GND (SCG)
Symmetry	SYM	45 % to 55 %			50 % V_{cc} level, $L_{CMOS}=\text{Max.}$
		$V_{cc}-0.4$ V Min.		$V_{cc}-0.4$ V Min.	$I_{OH}=-8$ mA
Output voltage	V_{OH}	$V_{cc}-0.4$ V Min.		0.4 V Max.	$I_{OL}=8$ mA
	V_{OL}	0.4 V Max.		0.4 V Max.	
Output load condition	L_{CMOS}	25 pF Max.		15 pF Max.	
Input voltage	V_{IH}	70 % V_{cc} Min.		70 % V_{cc} Min.	OE Terminal or \overline{ST} Terminal
	V_{IL}	20 % V_{cc} Max.		30 % V_{cc} Max.	
Rise time / Fall time	t_r / t_f	4 ns Max.			20 % V_{cc} to 80 % V_{cc} level, $L_{CMOS} \leq \text{Max.}$
Start-up time	t_{str}	12 ms Max.		10 ms Max.	$t=0$ at 90% V_{cc}
Frequency aging	f_{aging}	$\pm 5 \times 10^{-6}$ / year Max.			+25 °C, $V_{cc}=3.3$ V, First year

Specifications (characteristics)

Item	Symbol	Specifications			Conditions / Remarks
		SG-615PTW / STW SG-531PTW / STW	SG-615PHW / SHW SG-531PHW / SHW	SG-615PCW / SCW SG-531PCW / SCW	
Output frequency range	f_0	55.001 MHz to 135.000 MHz		26.001 MHz to 135.000 MHz	Please contact us about available frequencies.
Supply voltage	V_{cc}	5.0 V \pm 0.5 V		3.3 V \pm 0.3 V	
Storage temperature	T_{stg}	-55 °C to +125 °C			Storage as single product.
Operating temperature	T_{use}	-20 °C to +70 °C		-40 °C to +85 °C	
Frequency tolerance	f_{tol}	B: $\pm 50 \times 10^{-6}$, C: $\pm 100 \times 10^{-6}$		M: $\pm 100 \times 10^{-6}$	-20 °C to +70 °C -40 °C to +85 °C
Current consumption	I_{cc}	45 mA Max.		28 mA Max.	No load condition (Max. frequency range)
Disable current	I_{dis}	30 mA Max.		16 mA Max.	OE=GND (PTW,PHW,PCW)
Stand-by current	I_{std}	50 μ A Max.			\overline{ST} =GND (STW,SHW,SCW)
Symmetry	SYM	40 % to 60 %	40 % to 60 %	—	50 % V_{cc} level, L_{CMOS} =Max. 1.4 V level, L_{CMOS} =Max.
Output voltage	V_{OH} V_{OL}	V_{cc} -0.4 V Min. 0.4 V Max.			I_{OH} =-16 mA (PTW,STW,PHW,SHW), -8 mA (PCW,SCW) I_{OL} = 16 mA (PTW,STW,PHW,SHW), 8 mA (PCW,SCW)
Output load condition (TTL)	L_{TTL}	5 TTL Max.	—	—	$f_0 \leq 90$ MHz, Max.supply voltage
Output load condition (CMOS)	L_{CMOS}	15 pF Max.			Max.frequency, Max.supply voltage
Input voltage	V_{IH} V_{IL}	2.0 V Min. 0.8 V Max.		70 % V_{cc} Min. 20 % V_{cc} Max.	OE Terminal or \overline{ST} Terminal
Rise time / Fall time	t_r / t_f	—	—	4 ns Max.	20 % V_{cc} to 80 % V_{cc} level, $L_{CMOS} \leq$ Max. 0.4 V to 2.4 V level
Start-up time	t_{str}	10 ms Max.			Time at minimum supply voltage to be 0 s
Frequency aging	f_{aging}	$\pm 5 \times 10^{-6}$ / year Max.			+25 °C, V_{cc} =5.0 V / 3.3 V, First year

*2 "C" tolerance : $f_0 \geq 66.667$ MHz (PTW,STW,PHW,SHW)

Product Name **SG-615 P C G 20.000000MHz C**
 (Standard form) ① ②③ ④ ⑤
 ① Model ② Function (P: Output enable, S: Standby)
 ③ Supply voltage ④ Frequency
 ⑤ Frequency tolerance

③ Supply voltage	
C	3.3 V Typ.
T,H	5.0 V Typ.
Blank	5.0 V Typ.

⑤ Frequency tolerance	
B	$\pm 50 \times 10^{-6}$ / -20 to +70 °C
C	$\pm 100 \times 10^{-6}$ / -20 to +70 °C
M	$\pm 100 \times 10^{-6}$ / -40 to +85 °C

External dimensions

(Unit:mm)

Footprint (Recommended)

(Unit:mm)

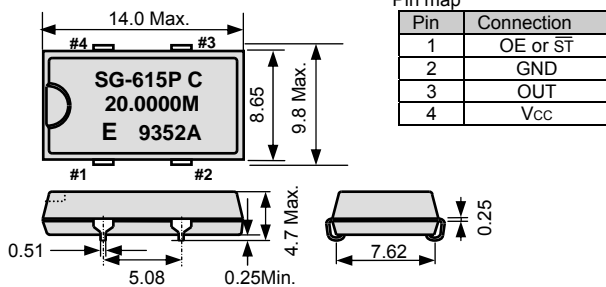
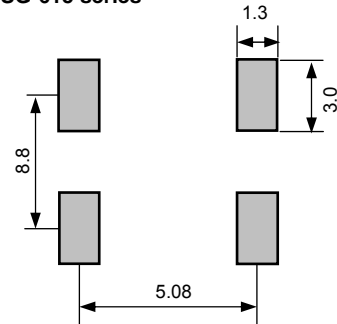
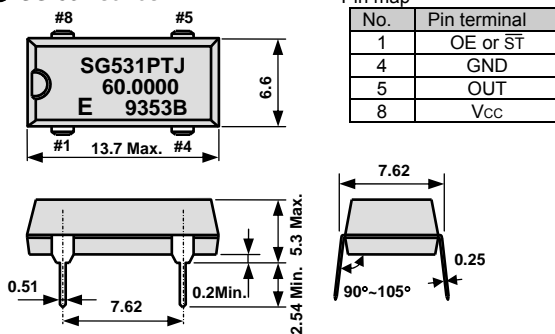
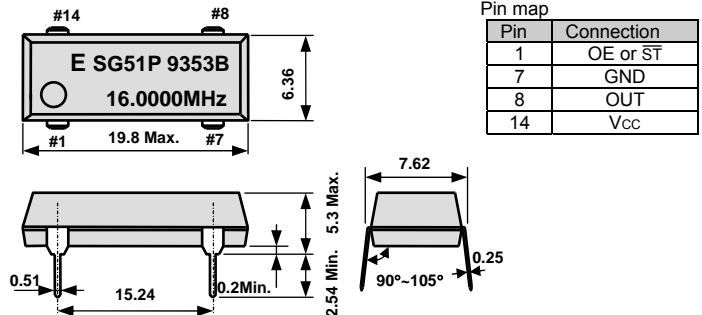
SG-615 series

SG-615 series

SG-531 series

SG-51 series

Note.
 OE pin (P,PTJ,PTW,PHW,PCW,PCN,PCG)
 OE pin = "H" or "open" : Specified frequency output.
 OE pin = "L" : Output is high impedance.

\overline{ST} pin (STW, SHW, SCW,SCG)
 \overline{ST} pin = "H" or "open" : Specified frequency output.
 \overline{ST} pin = "L" : Output is low level
 (weak pull - down), oscillation stops.

To maintain stable operation, provide a 0.01 μ F to 0.1 μ F by-pass capacitor at a location as near as possible to the power source terminal of the crystal product (between V_{cc} - GND).

PROMOTION OF ENVIRONMENTAL MANAGEMENT SYSTEM CONFORMING TO INTERNATIONAL STANDARDS

At Seiko Epson, all environmental initiatives operate under the Plan-Do-Check-Action (PDCA) cycle designed to achieve continuous improvements. The environmental management system (EMS) operates under the ISO 14001 environmental management standard.

All of our major manufacturing and non-manufacturing sites, in Japan and overseas, completed the acquisition of ISO 14001 certification.

ISO 14000 is an international standard for environmental management that was established by the International Standards Organization in 1996 against the background of growing concern regarding global warming, destruction of the ozone layer, and global deforestation.





WORKING FOR HIGH QUALITY

In order provide high quality and reliable products and services than meet customer needs,

Seiko Epson made early efforts towards obtaining ISO9000 series certification and has acquired ISO9001 for all business establishments in Japan and abroad. We have also acquired ISO/TS 16949 certification that is requested strongly by major automotive manufacturers as standard.

ISO/TS16949 is the international standard that added the sector-specific supplemental requirements for automotive industry based on ISO9001.

► Explanation of the mark that are using it for the catalog

	► Pb free.
	► Complies with EU RoHS directive. *About the products without the Pb-free mark. Contains Pb in products exempted by EU RoHS directive. (Contains Pb in sealing glass, high melting temperature type solder or other.)
	► Designed for automotive applications such as Car Multimedia, Body Electronics, Remote Keyless Entry etc.
	► Designed for automotive applications related to driving safety (Engine Control Unit, Air Bag, ESC etc.)

Notice

- This material is subject to change without notice.
- Any part of this material may not be reproduced or duplicated in any form or any means without the written permission of Seiko Epson.
- The information about applied circuitry, software, usage, etc. written in this material is intended for reference only. Seiko Epson does not assume any liability for the occurrence of infringing on any patent or copyright of a third party. This material does not authorize the licensing for any patent or intellectual copyrights.
- When exporting the products or technology described in this material, you should comply with the applicable export control laws and regulations and follow the procedures required by such laws and regulations.
- You are requested not to use the products (and any technical information furnished, if any) for the development and/or manufacture of weapon of mass destruction or for other military purposes. You are also requested that you would not make the products available to any third party who may use the products for such prohibited purposes.
- These products are intended for general use in electronic equipment. When using them in specific applications that require extremely high reliability, such as the applications stated below, you must obtain permission from Seiko Epson in advance.
/ Space equipment (artificial satellites, rockets, etc.) / Transportation vehicles and related (automobiles, aircraft, trains, vessels, etc.) / Medical instruments to sustain life / Submarine transmitters / Power stations and related / Fire work equipment and security equipment / traffic control equipment / and others requiring equivalent reliability.
- All brands or product names mentioned herein are trademarks and/or registered trademarks of their respective.

Mouser Electronics

Authorized Distributor

Click to View Pricing, Inventory, Delivery & Lifecycle Information:

Epson:

[SG-51P 22.1184MC: ROHS](#) [SG-51P 2.0000MC:ROHS](#) [SG-51P 24.5760MC:ROHS](#) [SG-51P 7.3728MC:ROHS](#) [SG-51P 8.0000MC:ROHS](#) [SG-51P 12.0000MC:ROHS](#) [SG-51P 16.0000MC:ROHS](#) [SG-51P 6.0000MC:ROHS](#) [SG-51P 10.0000MC:ROHS](#) [SG-51P 14.7456MC:ROHS](#)