

FEATURES

- Compact, Robust, Economical
- Up to 256 Pulses Per Revolution (PPR) in a 1" Square Sealed Package
- Bearing Model for High Operating Speeds
- New Low Profile Housing Style and Tachometer Output Available

The 900 Series offers a full line of low cost, rugged optical encoders with incremental output. Well suited for industrial motion and position sensing, their low profile and high resolution also make them ideal for panel mounted applications. A two-channel quadrature code allows the encoder to detect the direction and magnitude of the input motion applied to its shaft.

Available in this family of encoders is a new low profile package with internal bearings and integrated mounting holes.

Also new to the 900 Series is a high resolution tachometer style with single channel output. This style is particularly appropriate for applications involving ticket dispensing, card reading, or any speed-sensing function.

Up to 256 pulses per revolution (PPR) are available in a 1" square package. Working with standard decoding logic provided by the user's application software, the device produces 1024 changes of state per revolution with full quadrature decoding. Output is completely compatible with TTL circuitry, permitting entry of digital data without the cost of A/D conversion. Onboard Schmitt trigger circuitry produces crisp square wave output.

A sealed metal housing along with available die cast or stainless steel shaft ensure strength and accuracy in harsh environments. The semiconductor-based LED optical technology provides longer life and higher reliability than mechanical encoders or switches. Small in size, the encoder adapts well to new or retrofit applications. Output terminations available to match industry standard 4 or 5 pin configurations. This encoder may be directly coupled to a motor, gear, or axle. The threaded bushing allows easy system integration for these as well as panel mounted applications.

900 SERIES

OPTICAL ENCODERS

APPLICATIONS

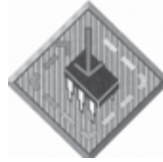

MOBILE SENSING / CONTROL

Motion and direction are sensed through encoder's shaft and sent directly to microprocessor.



MOTOR CONTROL DEVICES

Control of motor circuits is accomplished by linking encoder to motor shaft.

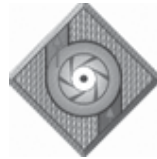

FLOW CONTROL DEVICES

Fluid flow can be metered by the encoder, attached to displacement, turbine and other styles of meters and pumps.



INPUT DEVICES

Panel mounted, the device is used as a low to high resolution input device for test and measurement, medical, and instrumentation of all varieties.

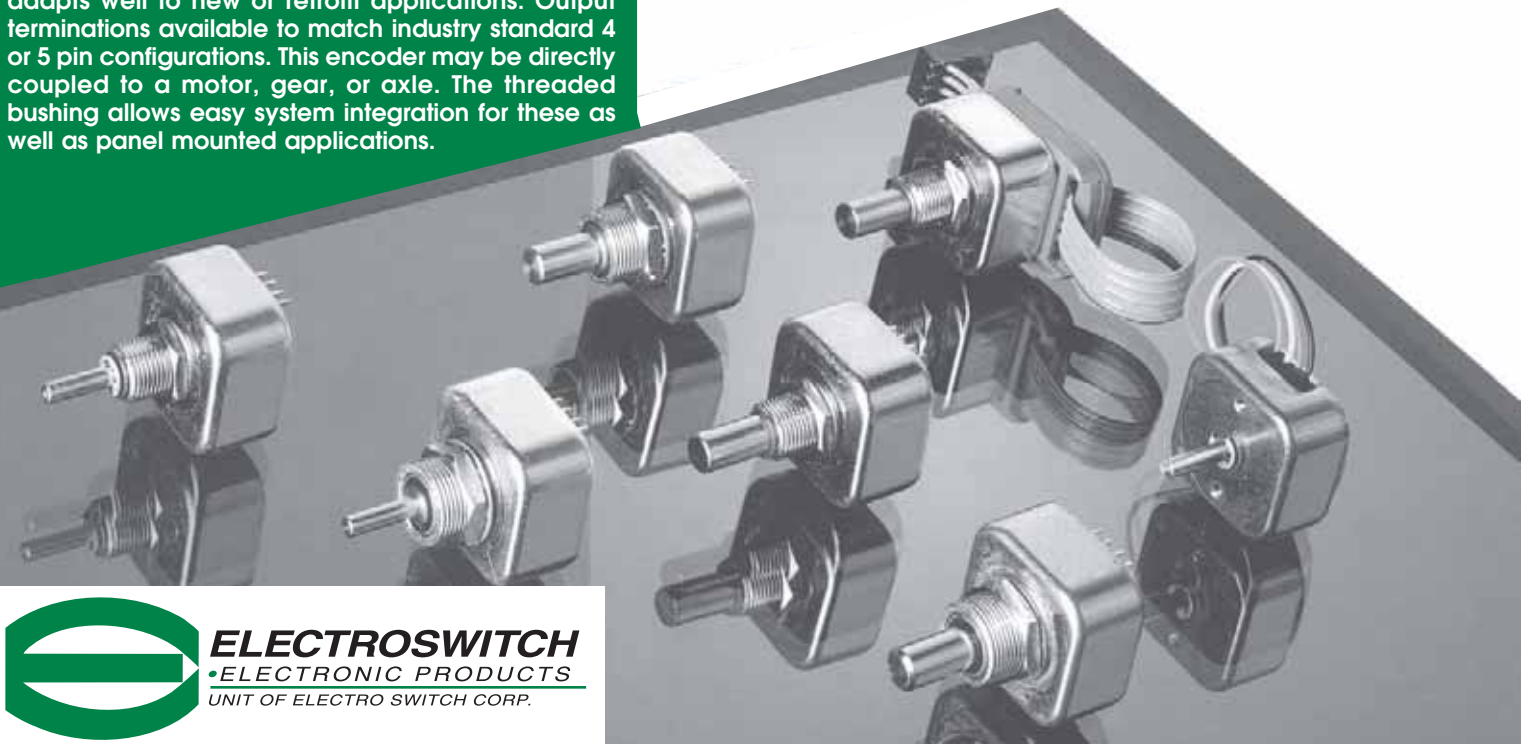

ELECTROSWITCH
•ELECTRONIC PRODUCTS
UNIT OF ELECTRO SWITCH CORP.

900 Series Encoder Configuration

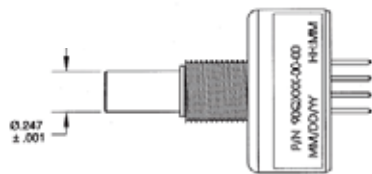

90 Series

Die Cast Shaft
Sleeve Bearing

93 Series

Stainless Steel Shaft
Sealed Ball Bearing

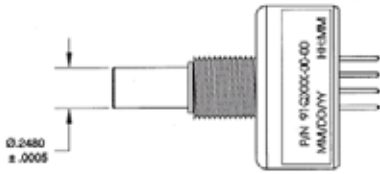
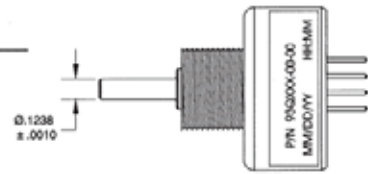

91 Series

Stainless Steel Shaft
Sealed Sleeve
Bearing

94 Series

Stainless Steel Shaft
Ball Bearing

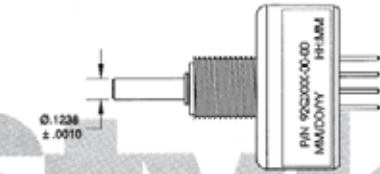
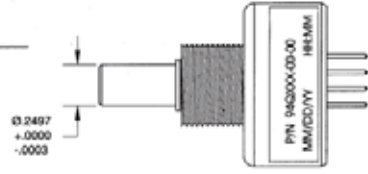

92 Series

Die Cast Shaft
Ball Bearing

95 Series

Stainless Steel Shaft
Sealed Ball Bearing

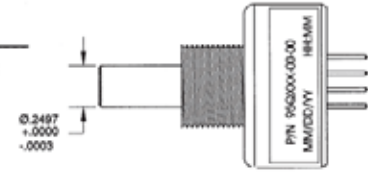

Styles

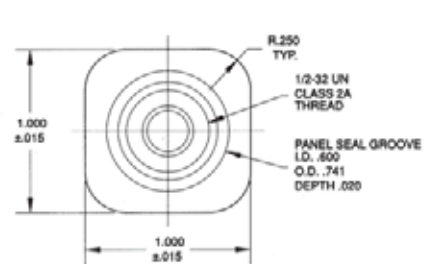
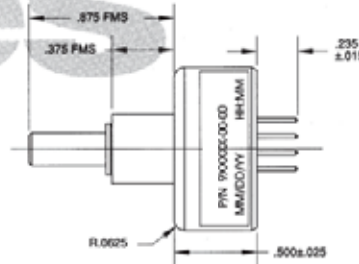
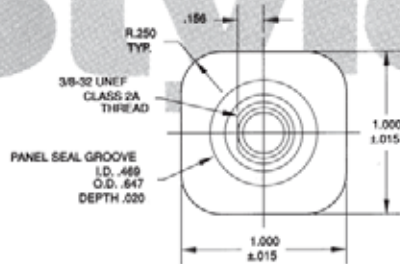

96 Series

Stainless Steel Shaft
Ball Bearing

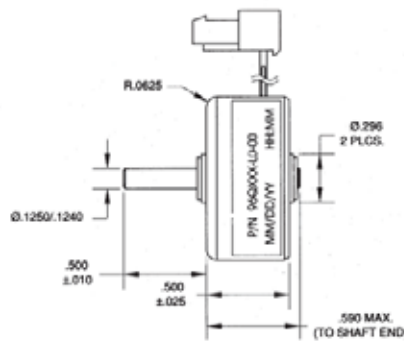
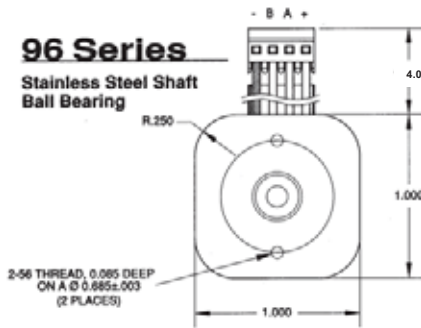

Notes:
All dimensions in inches unless otherwise specified.

Hardware:
All standard product comes with the following mounting hardware:
Nut
Hexagon machine screw nut, UNEF thread
Thickness: .093 ± .006
Lockwasher
Internal tooth
Thickness: .022

Pin Out Styles

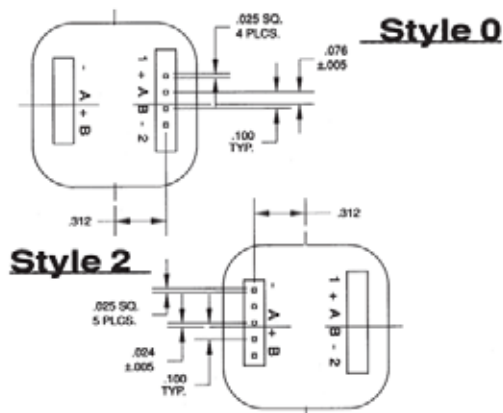

Cabin Styles

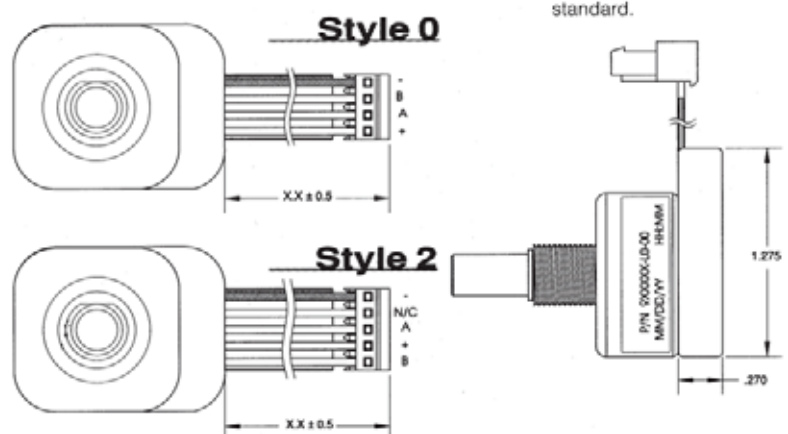

9000 SERIES

OPTICAL ENCODERS

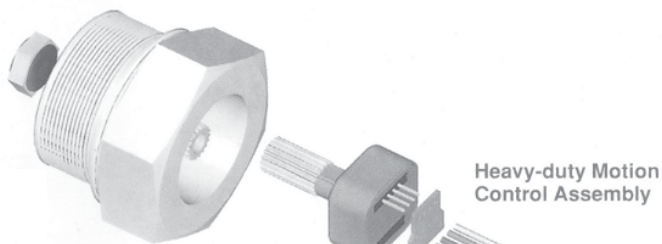

Value Added Assemblies

The Value Added Encoder Advantage

ELECTROSWITCH computer aided design and expertise in optics packaging make us the superior choice for value-added assemblies and specific production requirements.

Manufacturers benefit by shortening cycle time from design to production, and lowering Bill of Material count and cost. Ideal for use in feedback or panel applications, these value-added assemblies are certified, pretested, and ready to "plug and play" on your assembly line. **ELECTROSWITCH** is capable of extensive preproduction testing of your assemblies and components to assure that electrical, mechanical, and environmental specifications are met.

Manufacturers seeking a cost-effective single source for encoder assemblies can depend on **ELECTROSWITCH** powerful design and production solutions.

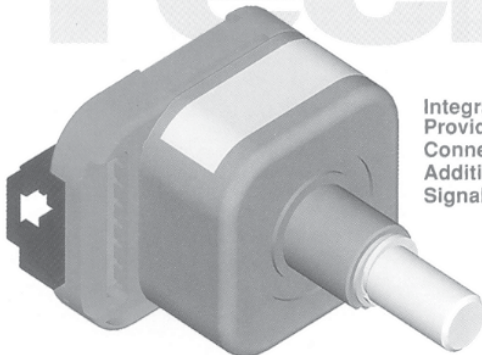

Performance Plus

Proprietary optical components allow **ELECTROSWITCH** to provide robust, compact, and economical encoders. The heart of these devices are monolithic Bi-Cell™ photo diodes with Schmitt Trigger circuitry.

Qualification of product using MIL-STD specifications sets SGI encoders apart from the competition.

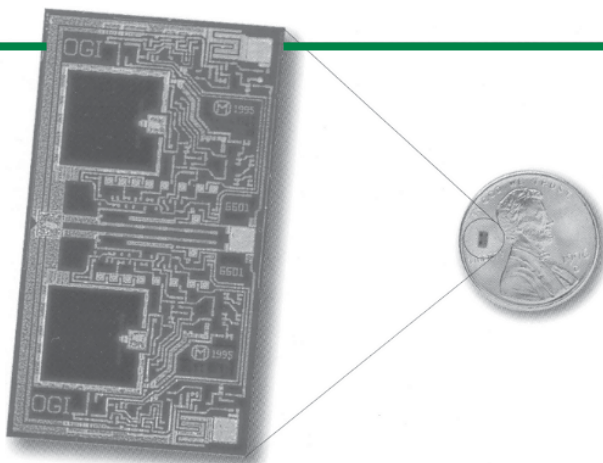

Specifications

Electrical Specifications

Parameter	Minimum	Typical	Maximum	Units
Vcc Range	4.75	5	5.25	V
<i>For 200 & 256 ppr only</i>	4.8	5	5.2	V
Supply Current @ 5V (Output Low) No Load		30	50	mA
VOH @ 100mA (Vcc = 5V)	3.0	4		V
VOL @ 16mA (Vcc = 4.75V)		290	700	mV
Pull-Up Resistor	7.5	10.5	13.5	KOhm
Output Rise Time (CL-15pF)		500		nS
Output Fall Time (CL-15pF)		14		nS
Output: 2-bit gray code, Channel A leads Channel B by 90° with clockwise rotation				
Power Consumption: 250mW max.				

Note: 1: Constant current source available for extended voltage ranges.
2: 12V and 15V input supply units available.

Environmental Specifications

Parameter	Minimum	Typical	Maximum	Units
Operating Temperature: Vcc = 5V	-40	25	85	°C
<i>For 200 & 256 ppr only</i>	0	20	50	°C
Storage Temperature Range: -55°C to +105°C, per MIL STD 202F Method 107G Test Condition A except 105°C max				
Humidity: MIL STD 202F Method 103B Condition A				
Solderability: 95% coverage				

Mechanical Specifications

Vibration: Harmonic motion with amplitude of 15g, varied from 10 to 2000 Hz for 12 hours, per MIL STD 202F Method 204D Condition B

Shock: 100g for 6 ms half sine wave with velocity change of 12.3 ft/s, per MIL STD 202F Method 213B Condition C

Rotational Torque: Sleeve bearing: < 1 in. oz. max., Ball bearing: < .25 in. oz. max., higher for sealed unit.

Operating Speed: Sleeve bearing: 200 RPM max., Ball bearing: 3,000 RPM max.

Shaft End Play: 0.005 max.

Shaft Radial Play: 0.010 max. @ .75 from mounting surface

Shaft Push In Force: 50 lbs. max.

Shaft Pull Out Force: 25 lbs. max.

Bushing Mounting Torque: 10 in. lb. max.

Weight: 1.1 oz. (90Q128-00-00)

Terminal Strength: 3 lbs. max. applied perpendicular to the terminals

Rotational Speed, Rotational Life and Shaft Side Load Rating:
(Load placed at end of standard shaft)

Series Number	Rotational Life	Rotational Speed Rating	Side Load Rating
90	5,000,000 +	200 rpm	0.25 lb.
91	10,000,000 +	300 rpm	0.50 lb.
92	100,000,000 +	3,000 rpm	0.25 lb.
93	100,000,000 +	3,000 rpm	5.0 lb.
94	100,000,000 +	3,000 rpm	5.0 lb.
95	100,000,000 +	3,000 rpm	5.0 lb.
96	100,000,000 +	3,000 rpm	3.0 lb.

Ordering the 900 Series Encoder

Output Style
Q = Quadrature (two channel)
T = Tachometer (single channel)

Resolution
(Pulses Per Revolution)
032 125
064 128
100

Pin Out Style
0 + A B -
2 - open A + B

Two Channel Waveform

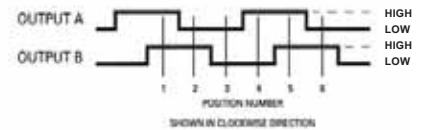

9 0 Q 0 3 2 - 0 0 - 0 0

Shaft and Bearing Style

- 0: 1/4" dia. shaft, sleeve bearing, 3/8" dia. bushing
- 1: 1/4" dia. shaft, sealed sleeve bearing, 3/8" dia. bushing
- 2: 1/8" dia. shaft, ball bearing, 3/8" dia. bushing
- 3: 1/8" dia. shaft, sealed ball bearing, 1/2" dia. bushing
- 4: 1/4" dia. shaft, ball bearing, 1/2" dia. bushing
- 5: 1/4" dia. shaft, sealed ball bearing, 1/2" dia. bushing
- 6: 1/8" dia. shaft, internal ball bearing

Termination

- 0: Straight Pins (see drawing)
 - 4: Standard 4' cable and connector
 - L: Custom cable length
- Example: 8 = 8' cable length

Electrical Schematic

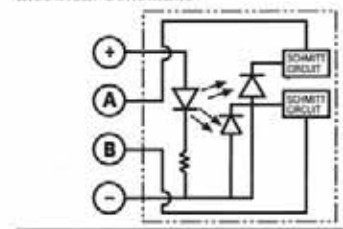

Mouser Electronics

Authorized Distributor

Click to View Pricing, Inventory, Delivery & Lifecycle Information:

[Electroswitch:](#)

[90Q128-00-00](#) [90Q064-00-00](#) [90Q128-40-00](#) [90Q064-40-00](#) [95Q256-40-00](#) [95Q256-00-00](#)