

ZXLD1352
30V 350mA LED DRIVER WITH 1000:1 PWM DIMMING AND AEC-Q100

Description

The ZXLD1352 is a continuous mode inductive step-down converter with integrated switch and high side current sense.

It operates from an input supply from 7V to 30V driving single and multiple series connected LEDs efficiently externally adjustable output current up to 350mA.

The ZXLD1352 has been qualified to AEC-Q100 Grade 2 allowing it to operate at ambient temperatures from -40 to 105°C.

DC voltage or a PWM waveform. 1000:1 adjustment of output current is possible using PWM control. Applying a voltage of 0.2V or lower to the ADJ pin turns the output off and switches the device into a low current standby state.

Features

- Simple low parts count
- Single pin on/off and brightness control using DC voltage or PWM
- 1000:1 PWM dimming range
- High efficiency (up to 95%)*
- Wide input voltage range: 7V to 30V
- 40V transient capability
- Up to 1MHz switching frequency
- Typical 4% output current accuracy
- Qualified to AEC-Q100 Grade 2
- Available in Green molding (no Br, Sb) with lead free finish/RoHS compliant

Applications

- Low voltage halogen replacement LEDs
- Automotive lighting
- Low voltage industrial lighting
- LED back-up lighting
- Illuminated signs

* Using standard external components as specified under electrical characteristics. Efficiency is dependent upon the number of LEDs driven and on external component types and values.

Pin Assignments

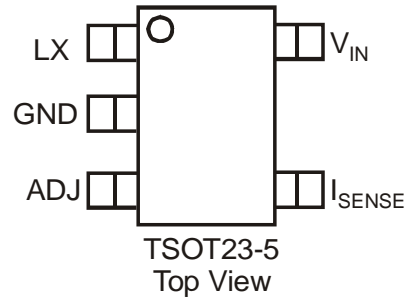

Typical Application Circuit

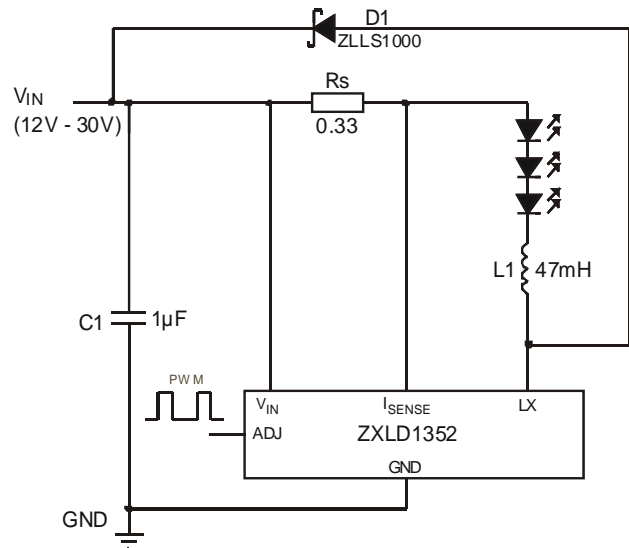

Block Diagram

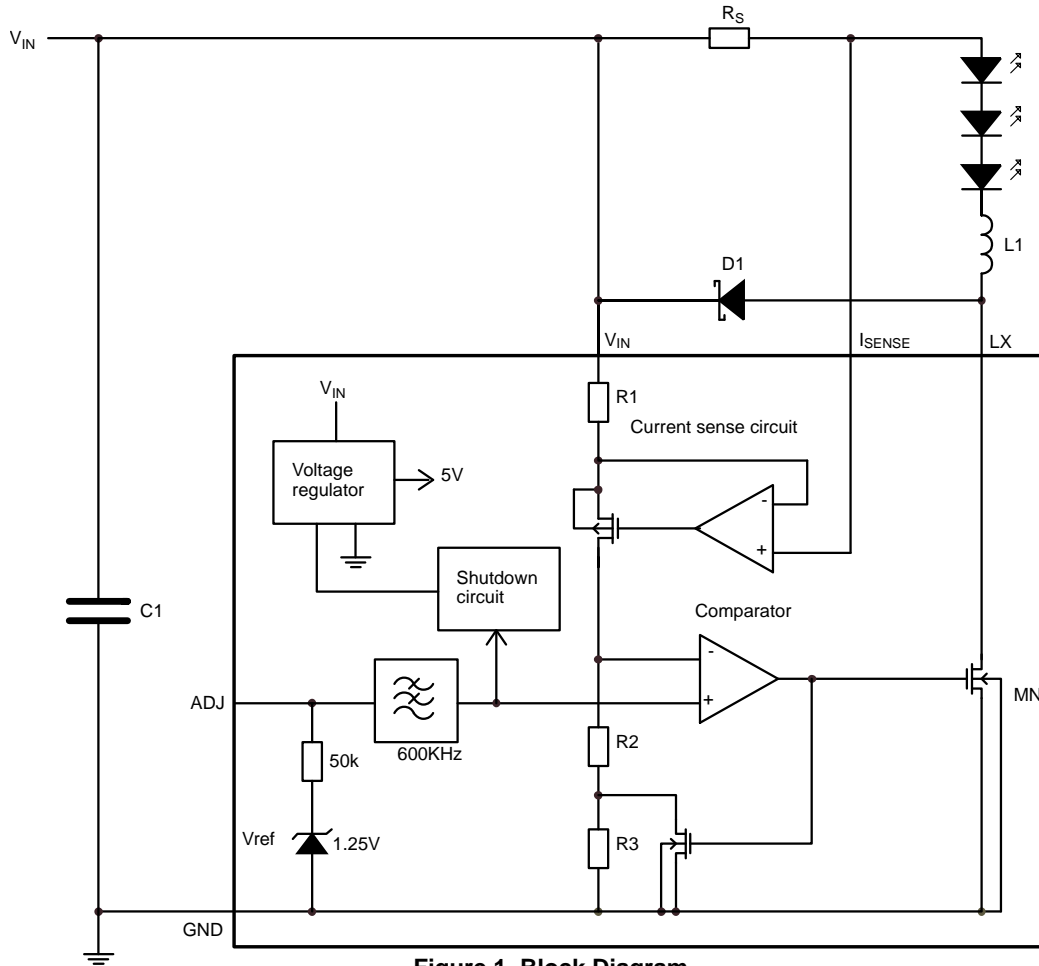

Figure 1. Block Diagram

Pin Description

Name	Pin No.	Description
LX	1	Drain of NDMOS switch
GND	2	Ground (0V)
ADJ	3	Multi-function On/Off and brightness control pin: <ul style="list-style-type: none"> • Leave floating for normal operation. ($V_{ADJ} = V_{REF} = 1.25V$ giving nominal average output current $I_{OUTnom} = 0.1/R_S$) • Drive to voltage below 0.2V to turn off output current • Drive with DC voltage ($0.3V < V_{ADJ} < 2.5V$) to adjust output current from 25% to 200%[†] of I_{OUTnom} • Drive with PWM signal from open-collector or open-drain transistor, to adjust output current. <ul style="list-style-type: none"> ◦ Adjustment range 0.1% to 100% of I_{OUTnom} for $100Hz < f < 1kHz$ • Connect a capacitor from this pin to ground to define soft-start time. Soft-start time is approx. $0.5ms/nF$
I_{SENSE}	4	Connect resistor R_S from this to V_{IN} to define nominal average output current $I_{OUTnom} = 0.1/R_S$ (Note: $R_{SMIN} = 0.27V$ with ADJ pin open circuit)
V_{IN}	5	Input voltage (7V to 30V). Decouple to ground with $1\mu F$ of higher X7R ceramic capacitor close to device

Absolute Maximum Ratings (Voltages to GND Unless Otherwise Stated)

Symbol	Parameter	Rating	Unit
V_{IN}	Input Voltage	-0.3 to +30 (40V for 0.5 sec)	V
V_{SENSE}	I_{SENSE} Voltage	+0.3 to -5 (measured with respect to V_{IN})	V
V_{LX}	LX Output Voltage	-0.3 to +30 (40V for 0.5 sec)	V
V_{ADJ}	Adjust Pin Input Voltage	-0.3 to +6	V
I_{LX}	Switch Output Current	500	mA
P_{TOT}	Power Dissipation (Refer to Package thermal de-rating curve on page 17)	450	mW
T_{ST}	Storage Temperature	-55 to 150	°C
$T_{J\ MAX}$	Junction Temperature	150	°C

These are stress ratings only. Operation above the absolute maximum rating may cause device failure. Operation at the absolute maximum ratings, for extended periods, may reduce device reliability.

Thermal Resistance

Symbol	Parameter	Rating	Unit
θ_{JA}	Junction to Ambient	200	°C/W

Recommended Operating Conditions

Symbol	Parameter	Min	Max	Units
V_{IN}	Input voltage	7	30	V
t_{OFFMIN}	Minimum switch off-time		200	ns
t_{ONMIN}	Minimum switch on-time		200	ns
f_{LXmax}	Recommended maximum operating frequency		1	MHz
D_{LX}	Duty cycle range	0.01	0.99	
T_A	Ambient Temperature range	-40	105	°C

Electrical Characteristics (Test conditions: $V_{IN} = 12V$, $T_{amb} = 25^{\circ}C$, unless otherwise specified.)

Symbol	Parameter	Conditions	Min.	Typ.	Max.	Unit
V_{SU}	Internal regulator start-up threshold	V_{IN} rising		4.8		V
I_{INQoff}	Quiescent supply current with output off	ADJ pin grounded		20	30	μA
I_{INQon}	Quiescent supply current with output switching	ADJ pin floating $f = 250kHz$		250	500	μA
V_{SENSE}	Mean current sense threshold voltage (defines LED current setting accuracy)	Measured on I_{SENSE} pin with respect to V_{IN} $V_{ADJ} = 1.25V$	95	100	105	mV
$V_{SENSEHYS}$	Sense threshold hysteresis			± 15		%
I_{SENSE}	I_{SENSE} pin input current	$V_{SENSE} = V_{IN} - 0.1$		1.25	10	μA
V_{REF}	Internal reference voltage	Measured on ADJ pin with pin floating	1.21	1.25	1.29	V
$\Delta V_{REF} / \Delta T$	Temperature coefficient of V_{REF}			50		ppm/ $^{\circ}C$
V_{ADJ}	External control voltage range on ADJ pin for dc brightness control ¹		0.3		2.5	V
V_{ADJoff}	DC voltage on ADJ pin to switch device from active (on) state to quiescent (off) state	V_{ADJ} falling	0.15	0.2	0.25	V
V_{ADJon}	DC voltage on ADJ pin to switch device from quiescent (off) state to active (on) state	V_{ADJ} rising	0.2	0.25	0.3	V
R_{ADJ}	Resistance between ADJ pin and V_{REF}		35		65	k Ω
I_{LXmean}	Continuous LX switch current				0.37	A
R_{LX}	LX Switch 'On' resistance			1.5	2	Ω
$I_{LX(leak)}$	LX switch leakage current				1	μA
$D_{PWM(LF)}$	Duty cycle range of PWM signal applied to ADJ pin during PWM dimming mode	PWM frequency 100Hz – 1kHz PWM amplitude = V_{REF} Measured on ADJ pin	0.001		1	
	Brightness control range			1000:1		
f_{LX}	Operating frequency (See graphs for more detail)	ADJ pin floating $L = 100\mu H$ (0.82V) $I_{OUT} = 350mA$ @ $V_{LED} = 3.4V$ Driving 1 LED		250		kHz
t_{PD}	Internal comparator propagation delay			50		ns

- Notes:
1. Production testing of the device is performed at 25°C. Functional operation of the device and parameters specified over a -40°C to +105°C temperature range, are guaranteed by design, characterization and process control.
 2. 100% brightness corresponds to $V_{ADJ} = V_{ADJ(nom)} = V_{REF}$. Driving the ADJ pin above V_{REF} will increase the V_{SENSE} threshold and output current proportionally.

Device Description

The device, in conjunction with the coil (L1) and current sense resistor (RS), forms a self-oscillating continuous-mode buck converter

Device operation (Refer to block diagram and Figure 1 - Operating waveforms)

Operation can be best understood by assuming that the ADJ pin of the device is unconnected and the voltage on this pin (V_{ADJ}) appears directly at the (+) input of the comparator.

When input voltage V_{IN} is first applied, the initial current in L1 and R_S is zero and there is no output from the current sense circuit. Under this condition, the (-) input to the comparator is at ground and its output is high. This turns MN on and switches the LX pin low, causing current to flow from V_{IN} to ground, via R_S , L1 and the LED(s). The current rises at a rate determined by V_{IN} and L1 to produce a voltage ramp (V_{SENSE}) across R_S . The supply referred voltage V_{SENSE} is forced across internal resistor R1 by the current sense circuit and produces a proportional current in internal resistors R2 and R3. This produces a ground referred rising voltage at the (-) input of the comparator. When this reaches the threshold voltage (V_{ADJ}), the comparator output switches low and MN turns off. The comparator output also drives another NMOS switch, which bypasses internal resistor R3 to provide a controlled amount of hysteresis. The hysteresis is set by R3 to be nominally 15% of V_{ADJ} .

When MN is off, the current in L1 continues to flow via D1 and the LED(s) back to V_{IN} . The current decays at a rate determined by the LED and diode forward voltages to produce a falling voltage at the input of the comparator. When this voltage returns to V_{ADJ} , the comparator output switches high again. This cycle of events repeats, with the comparator input ramping between limits of $V_{ADJ} \pm 15\%$.

Switching thresholds

With $V_{ADJ} = V_{REF}$, the ratios of R1, R2 and R3, define an average V_{SENSE} switching threshold of 100mV (measured on the I_{SENSE} pin with respect to V_{IN}). The average output current I_{OUTnom} is then defined by this voltage and R_S according to:

$$I_{OUTnom} = 100mV / R_S$$

Nominal ripple current is $\pm 15mV / R_S$

Adjusting output current

The device contains a low pass filter for noise suppression between the ADJ pin and the threshold comparator and an internal current limiting resistor (50k nom) between ADJ and the internal reference voltage. This allows the ADJ pin to be overdriven with either DC or PWM signals to adjust the output current. The filter is first order, comprising one section with a cut-off frequency of nominally 600kHz.

Details of the different modes of adjusting output current are given in the applications section.

Output shutdown

The ADJ pin drives the shutdown circuit. When the input voltage to this circuit falls below the threshold (0.2V nom), the internal regulator and the output switch are turned off. The voltage reference remains powered during shutdown to provide the bias current for the shutdown circuit. Quiescent supply current during shutdown is nominally 20mA and switch leakage is below 1mA.

Device Description

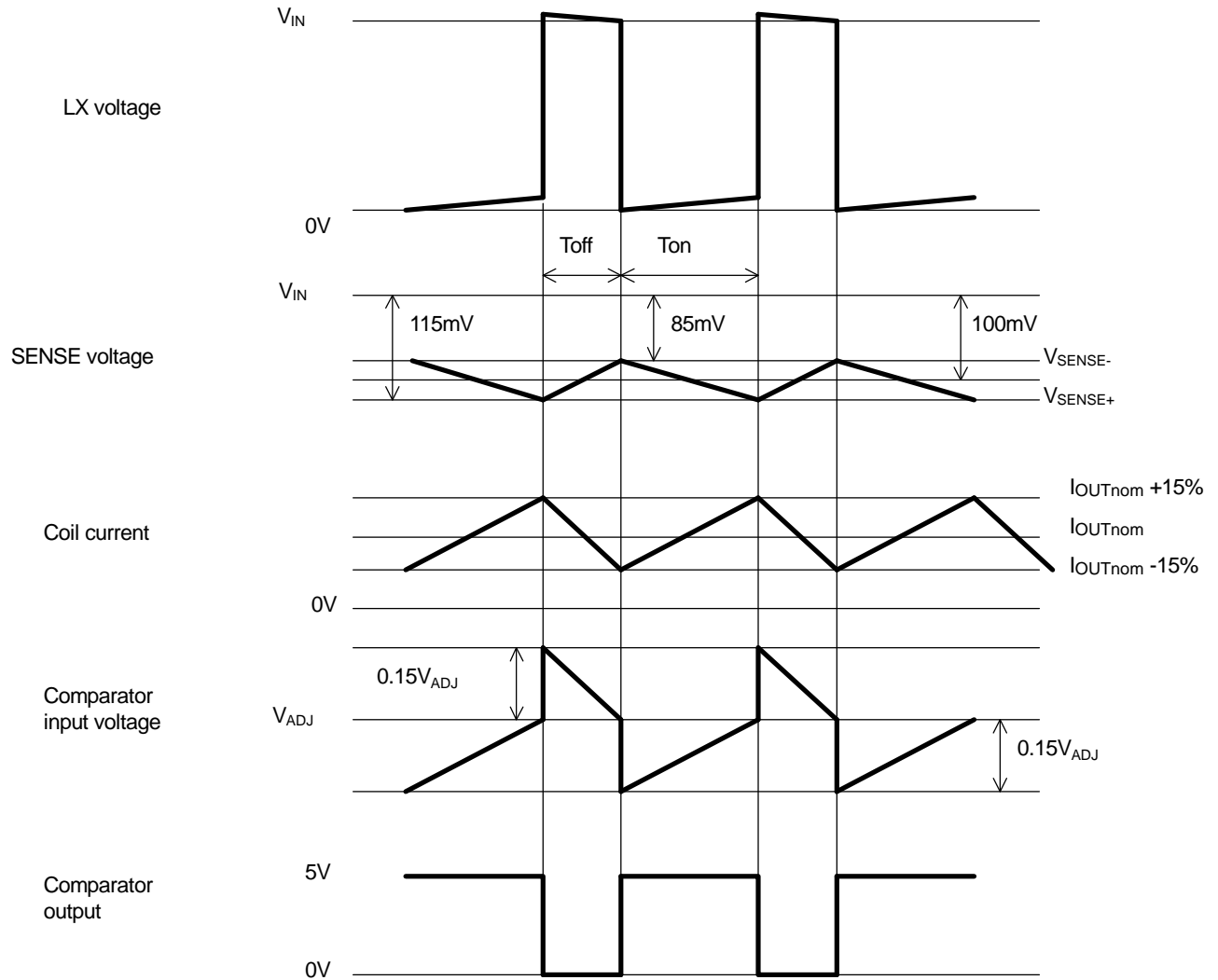
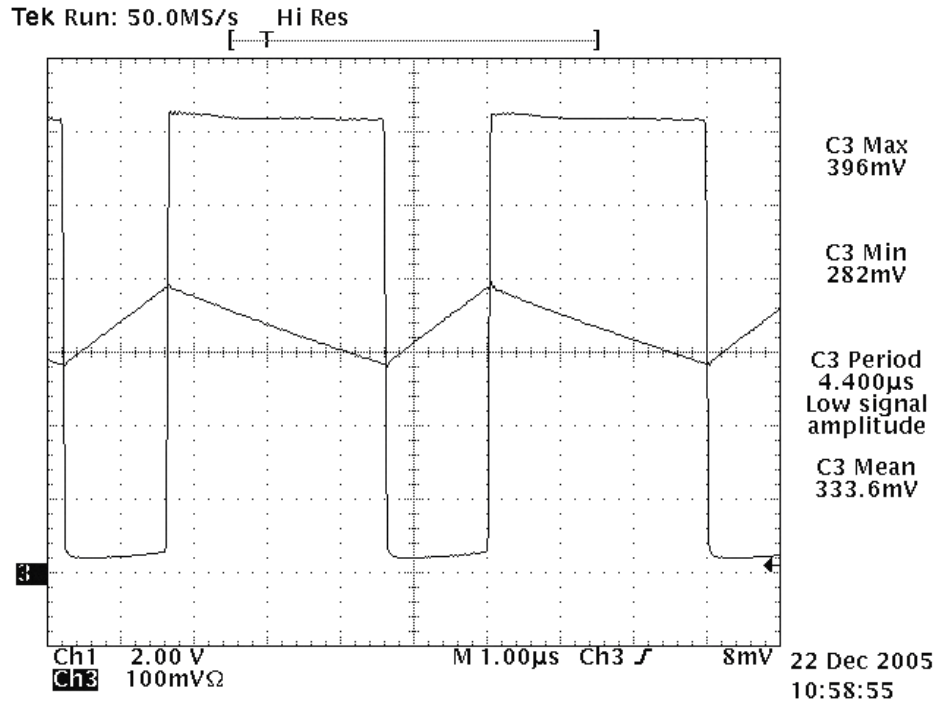
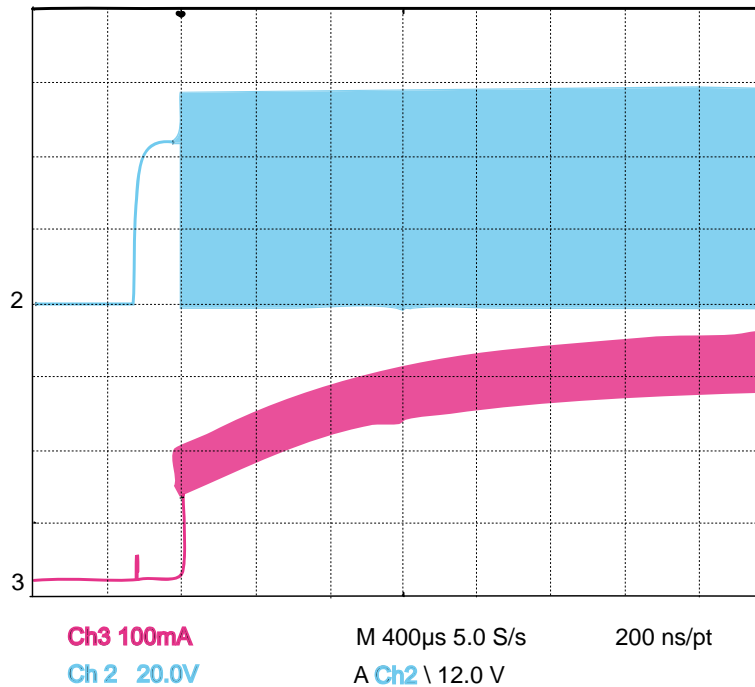

Figure 2. Operating Waveforms

Typical Operating Waveforms [$V_{IN} = 12V$, $R_S = 0.3\Omega$, $L = 100\mu H$]



Normal Operation. Output Current (Ch3) and LX Voltage (Ch1)



Start-up Waveforms. Output Current (Ch3), LX Voltage (Ch2)

Typical Characteristics

For typical application circuit driving 1W Luxeon® white LED(s) at $V_{IN}=12V$ and $T_{amb}=25^{\circ}C$ unless otherwise stated.

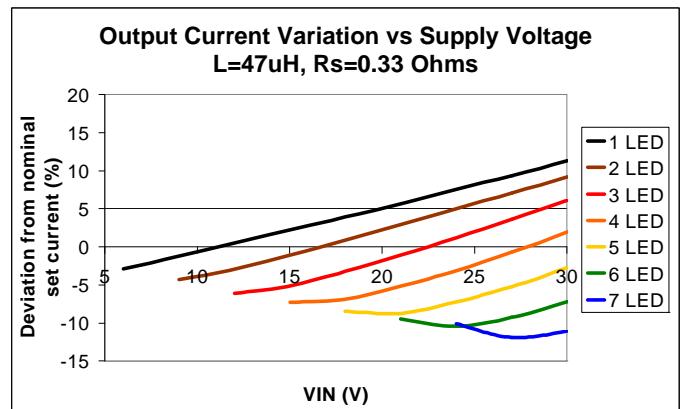
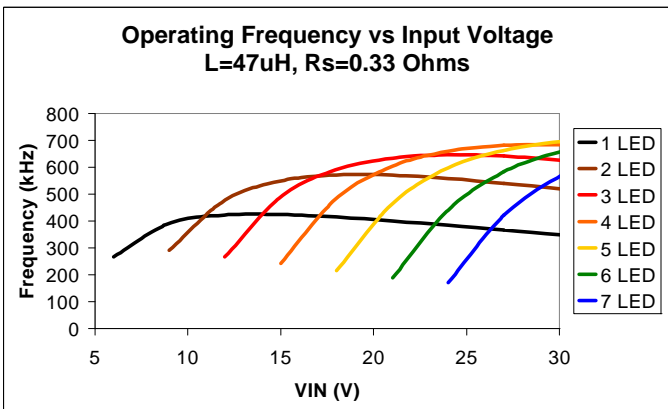
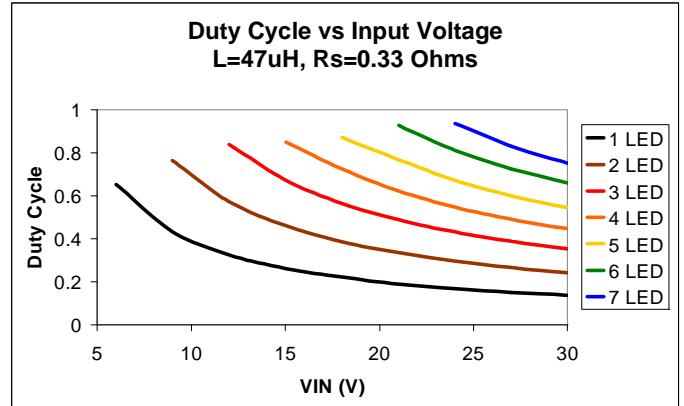
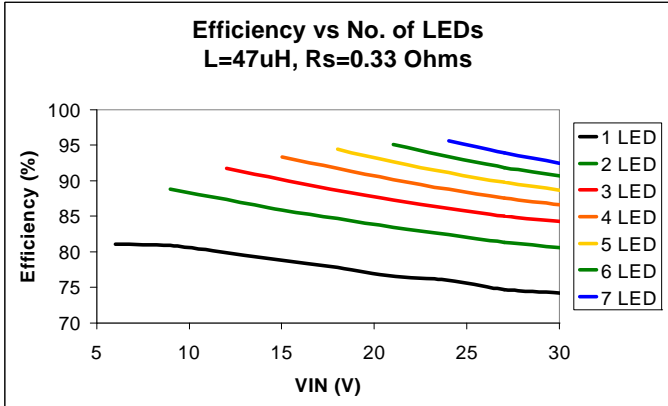
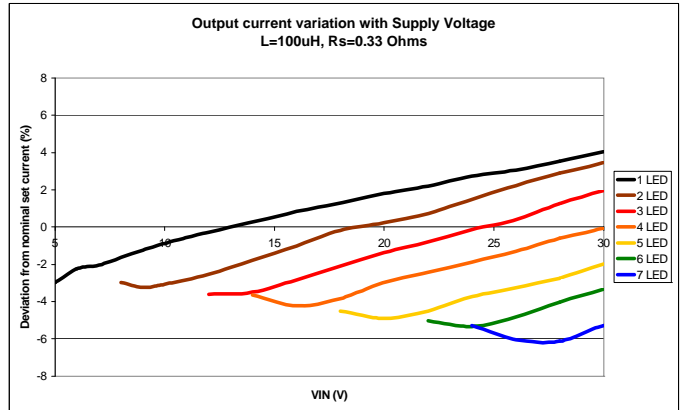
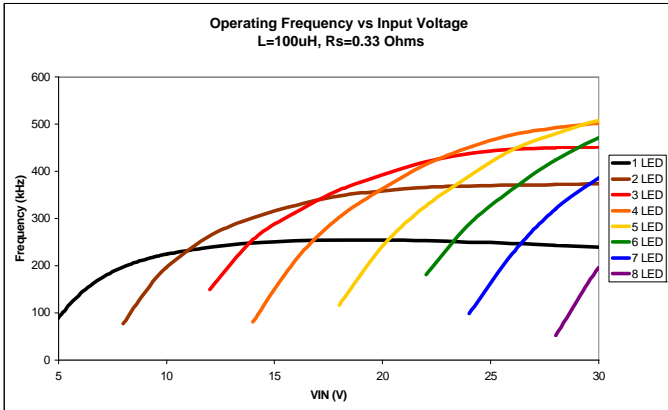
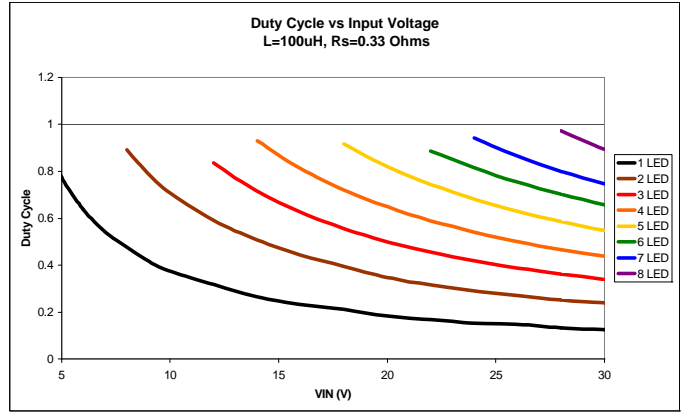
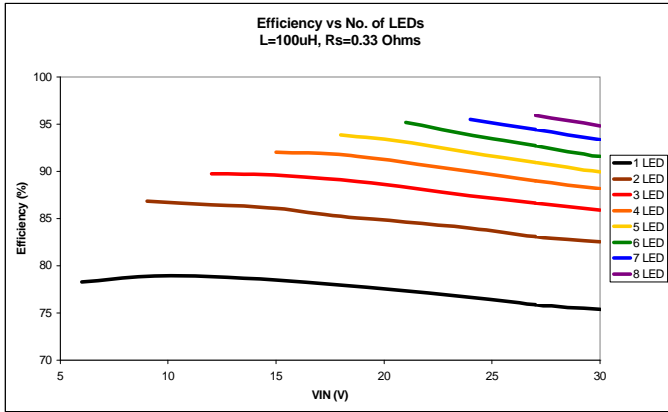

Typical Characteristics (Cont.)

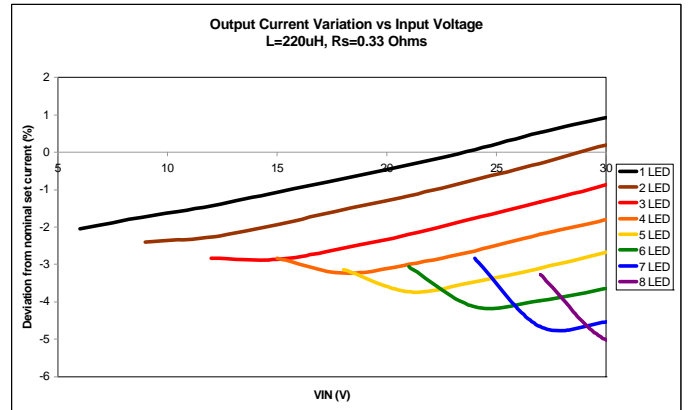
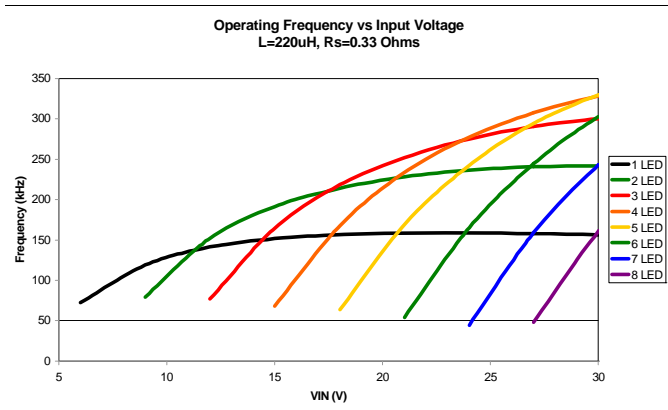
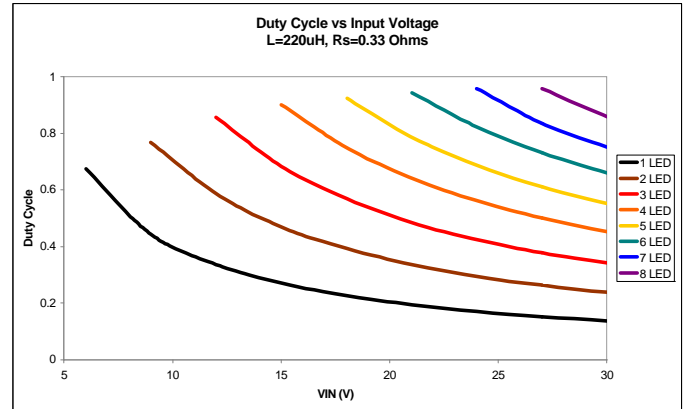
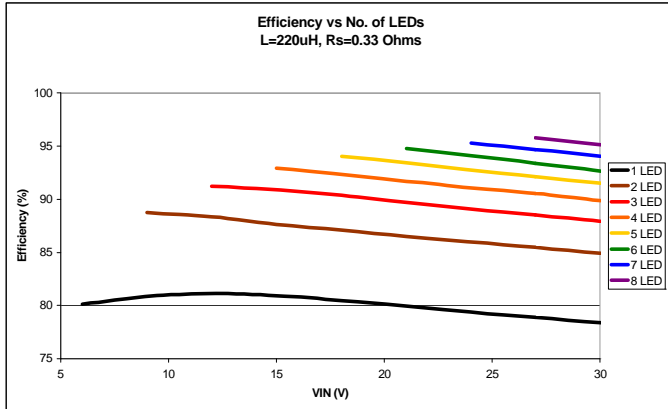

Typical Characteristics (Cont.)

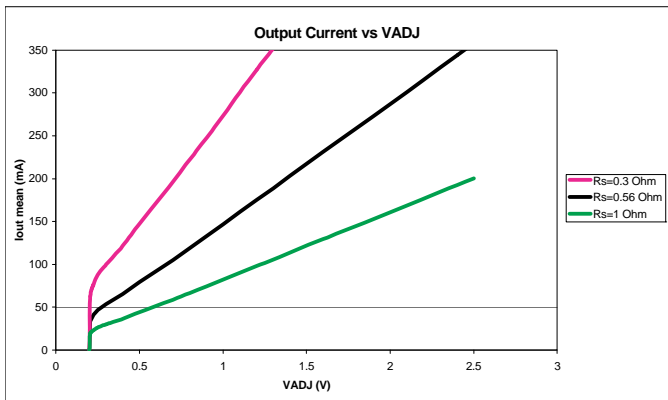
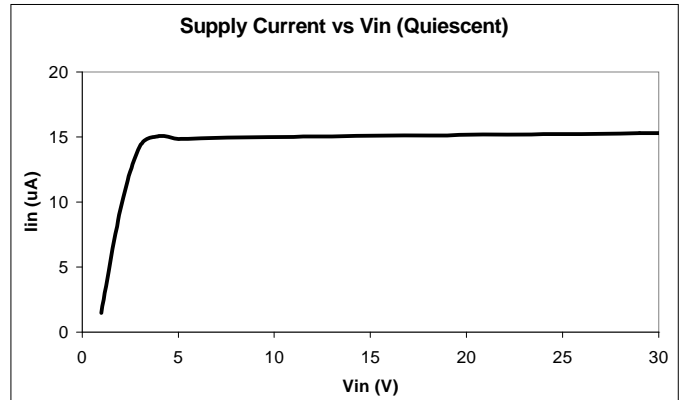
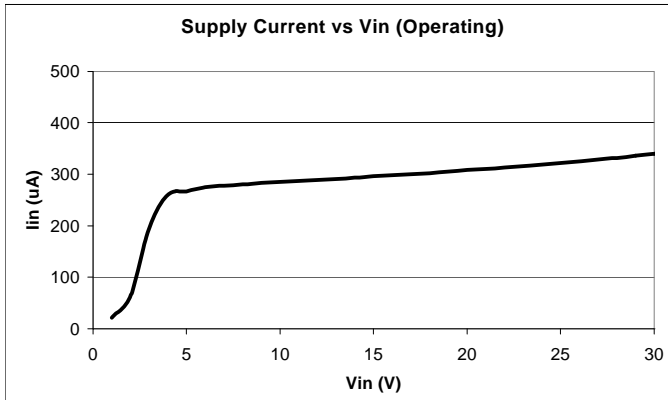
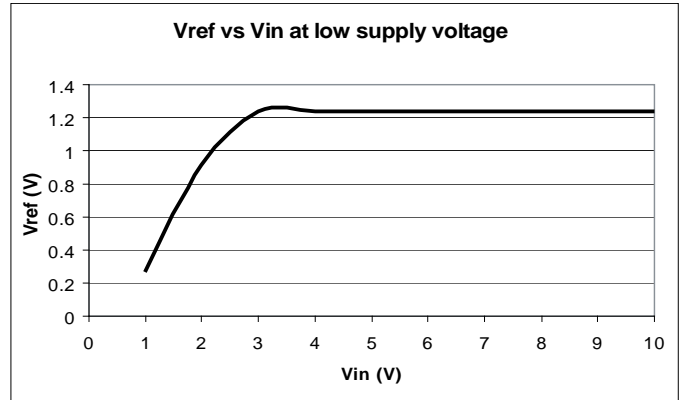
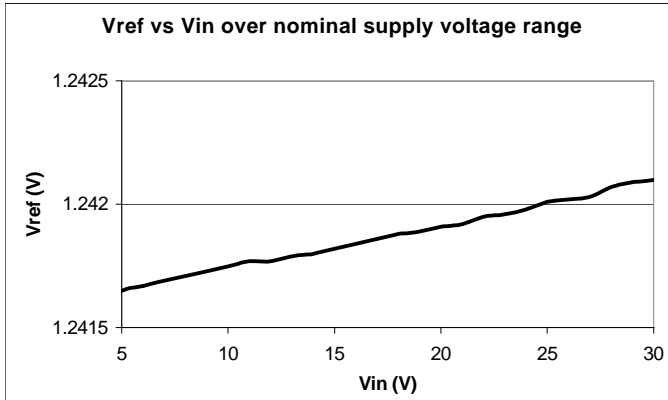

Typical Characteristics (Cont.)

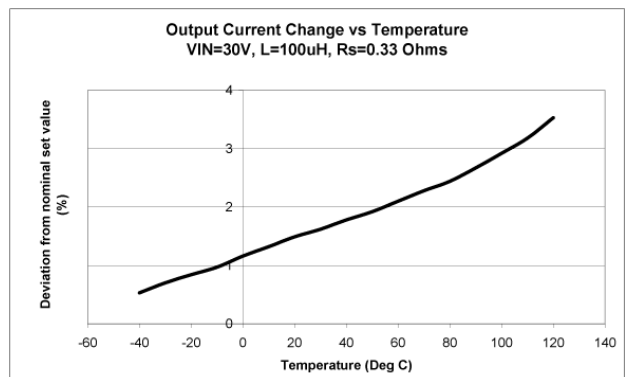
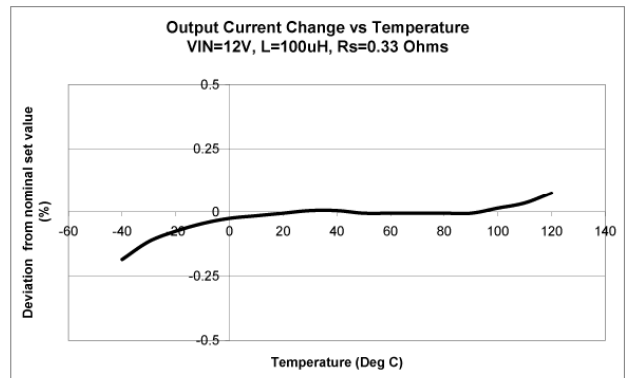
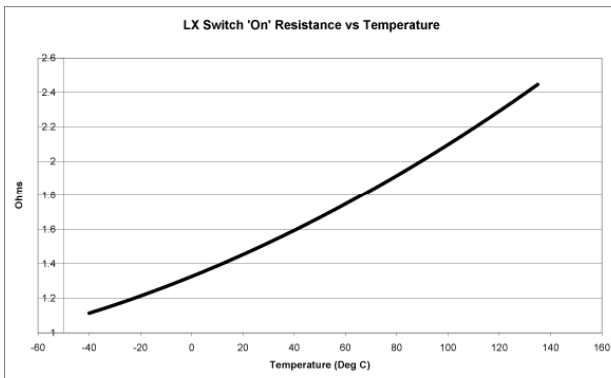
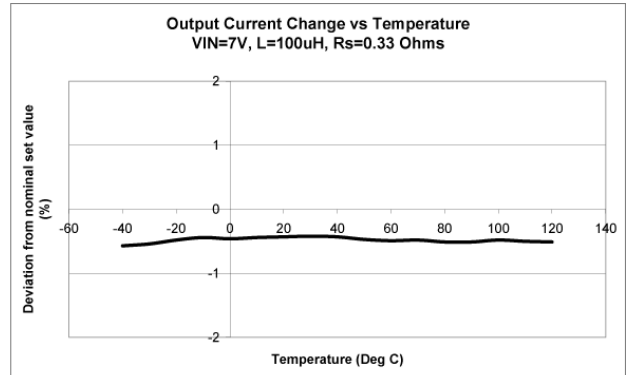
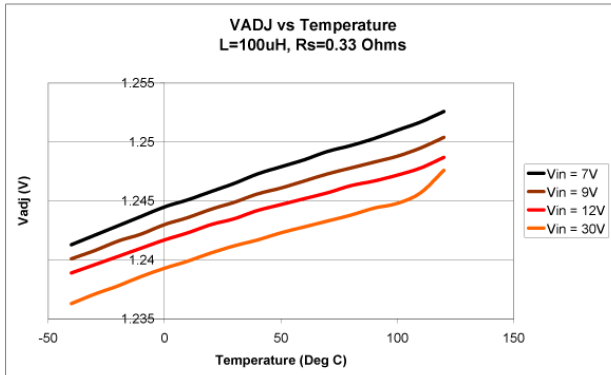

Application Information

Setting nominal average output current with external resistor R_S

The nominal average output current in the LED(s) is determined by the value of the external current sense resistor (R_S) connected between V_{IN} and I_{SENSE} and is given by:

$$I_{OUTnom} = 0.1/R_S \quad \text{for } R_S > 0.27\Omega$$

The table below gives values of nominal average output current for several preferred values of current setting resistor (R_S) in the typical application circuit shown on page 1:

R_S (Ω)	Nominal average output current (mA)
0.27	370
0.3	333
0.33	300
0.39	256

The above values assume that the ADJ pin is floating and at a nominal voltage of V_{REF} ($=1.25V$). Note that $R_S=0.27\Omega$ is the minimum allowed value of sense resistor under these conditions to maintain switch current below the specified maximum value.

It is possible to use different values of R_S if the ADJ pin is driven from an external voltage. (See next section).

Output current adjustment by external DC control voltage

The ADJ pin can be driven by an external dc voltage (V_{ADJ}), as shown, to adjust the output current to a value above or below the nominal average value defined by R_S .

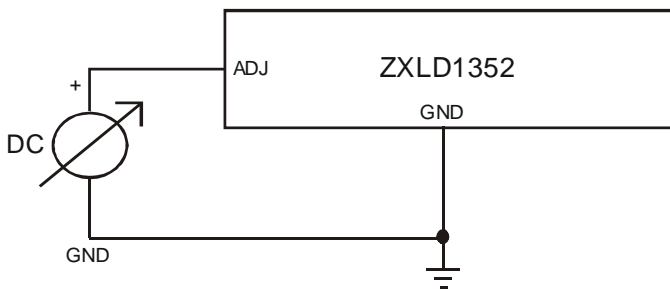

The nominal average output current in this case is given by:

$$I_{OUTdc} = 0.08 \cdot V_{ADJ} / R_S \quad [\text{for } 0.3 < V_{ADJ} < 2.5V]$$

Note that 100% brightness setting corresponds to $V_{ADJ} = V_{REF}$. When driving the ADJ pin above 1.25V, R_S must be increased in proportion to prevent I_{OUTdc} exceeding 370mA maximum.

The input impedance of the ADJ pin is $50k\Omega \pm 25\%$.

Application Information (Continued)

Output Current Adjustment by PWM Control

Directly driving ADJ input

A Pulse Width Modulated (PWM) signal with duty cycle D_{PWM} can be applied to the ADJ pin, as shown below, to adjust the output current to a value above or below the nominal average value set by resistor R_S :

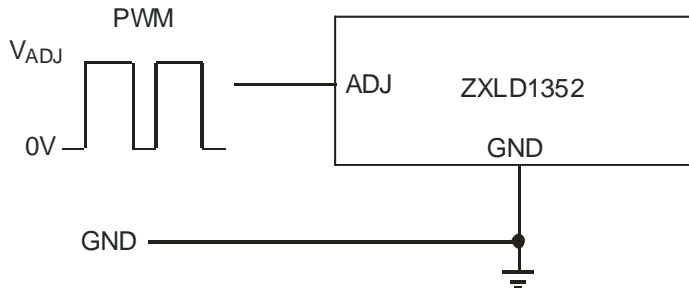

Driving the ADJ input via open collector transistor

The recommended method of driving the ADJ pin and controlling the amplitude of the PWM waveform is to use a small NPN switching transistor as shown below:

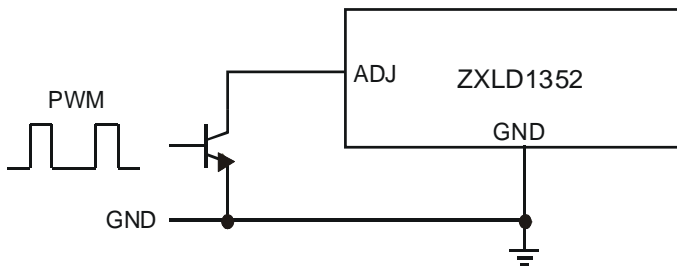

This scheme uses the 50k resistor between the ADJ pin and the internal voltage reference as a pull-up resistor for the external transistor eg MMBT3904.

Driving the ADJ input from a microcontroller

Another possibility is to drive the device from the open drain output of a microcontroller. The diagram below shows one method of doing this:

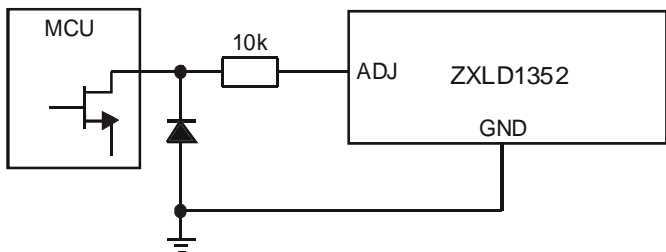

If the NMOS transistor within the microcontroller has high Gate / Drain capacitance, this arrangement can inject a negative spike into ADJ input of the ZXLD1352 and cause erratic operation but the addition of a Schottky clamp diode (eg Diodes Inc. SD103CWS) to ground and inclusion of a series resistor (3.3k) will prevent this. See the section on PWM dimming for more details of the various modes of control using high frequency and low frequency PWM signals.

Application Information (Continued)

Shutdown Mode

Taking the ADJ pin to a voltage below 0.2V will turn off the output and supply current will fall to a low standby level of 20µA nominal.

Note that the ADJ pin is not a logic input. Taking the ADJ pin to a voltage above V_{REF} will increase output current above the 100% nominal average value. (See graphs for details).

Soft-start

An external capacitor from the ADJ pin to ground will provide soft-start delay, by increasing the time taken for the voltage on this pin to rise to the turn-on threshold and by slowing down the rate of rise of the control voltage at the input of the comparator. The graph below shows the variation of soft-start time for different values of capacitor.

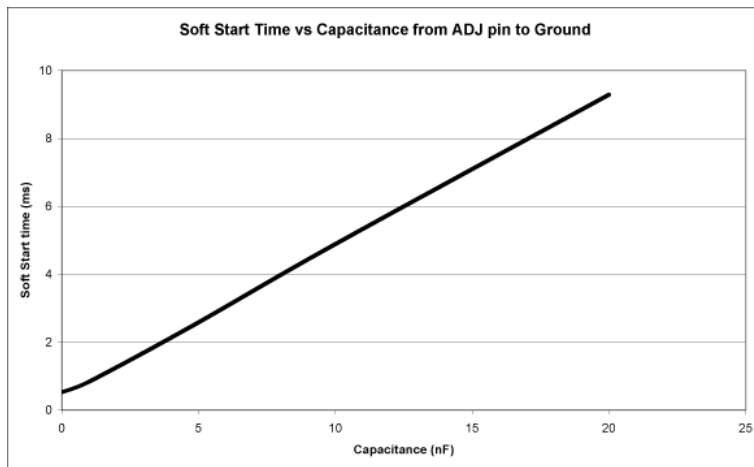

Inherent open-circuit LED protection

If the connection to the LED(s) is open-circuited, the coil is isolated from the LX pin of the chip, so the device will not be damaged, unlike in many boost converters, where the back EMF may damage the internal switch by forcing the drain above its breakdown voltage.

Capacitor selection

A low ESR capacitor should be used for input decoupling, as the ESR of this capacitor appears in series with the supply source impedance and lowers overall efficiency. This capacitor has to supply the relatively high peak current to the coil and smooth the current ripple on the input supply. A minimum value of 1µF is acceptable if the input source is close to the device, but higher values will improve performance at lower input voltages, especially when the source impedance is high. The input capacitor should be placed as close as possible to the IC.

For maximum stability over temperature and voltage, capacitors with X7R, X5R, or better dielectric are recommended. Capacitors with Y5V dielectric are not suitable for decoupling in this application and should **NOT** be used.

A table of recommended manufacturers is provided below:

Manufacturer	Website
Murata	www.murata.com
Taiyo Yuden	www.t-yuden.com
Kemet	www.kemet.com
AVX	www.avxcorp.com

Application Information (Continued)

Inductor Selection

Recommended inductor values for the ZXLD1352 are in the range 47µH to 220µH.

Higher values of inductance are recommended at higher supply voltages in order to minimize errors due to switching delays, which result in increased ripple and lower efficiency. Higher values of inductance also result in a smaller change in output current over the supply voltage range. (See graphs). The inductor should be mounted as close to the device as possible with low resistance connections to the LX and V_{IN} pins.

The chosen coil should have a saturation current higher than the peak output current and a continuous current rating above the required mean output current.

Suitable coils for use with the ZXLD1352 are listed in the table below:

Part No.	L (µH)	DCR (Ω)	I _{SAT} (A)	Manufacturer
DO1608C	47	0.64	0.5	CoilCraft
MSS6132ML	47	0.38	0.56	
	68	0.58	0.47	
	100	0.82	0.39	
CD104-MC	220	0.55	0.53	Sumida
NP04SB470M	47	0.27	0.38	Taiyo Yuden

The inductor value should be chosen to maintain operating duty cycle and switch 'on'/off' times within the specified limits over the supply voltage and load current range.

The following equations can be used as a guide, with reference to Figure 1 - Operating waveforms.

LX Switch 'On' time

$$T_{ON} = \frac{L\Delta I}{V_{IN} - V_{LED} - I_{avg}(R_S + r_L + R_{LX})}$$

Note: T_{ONmin}>200ns

LX Switch 'Off' time

$$T_{OFF} = \frac{L\Delta I}{V_{LED} + V_D + I_{avg}(R_S + r_L)}$$

Note: T_{OFFmin}>200ns

Where:

L is the coil inductance (H)

rL is the coil resistance (Ω)

I_{avg} is the required LED current (A)

ΔI is the coil peak-peak ripple current (A) {Internally set to 0.3 x I_{avg}}

V_{IN} is the supply voltage (V)

V_{LED} is the total LED forward voltage (V)

R_{LX} is the switch resistance (Ω)

V_D is the diode forward voltage at the required load current (V)

Application Information (Continued)

Example

For $V_{IN} = 12V$, $L = 47\mu H$, $r_L = 0.64\Omega$, $V_{LED} = 3.4V$, $I_{avg} = 350mA$ and $V_D = 0.36V$

$$T_{ON} = (47e-6 \times 0.105) / (12 - 3.4 - 0.672) = 0.622\mu s$$

$$T_{OFF} = (47e-6 \times 0.105) / (3.4 + 0.36 + 0.322) = 1.21\mu s$$

This gives an operating frequency of 546kHz and a duty cycle of 0.34.

These and other equations are available as a spreadsheet calculator from the Zetex website. Go to www.diodes.com/ZXLD1352

Note that in practice, the duty cycle and operating frequency will deviate from the calculated values due to dynamic switching delays, switch rise/fall times and losses in the external components.

Optimum performance will be achieved by setting the duty cycle close to 0.5 at the nominal supply voltage. This helps to equalize the undershoot and overshoot and improves temperature stability of the output current.

Diode selection

For maximum efficiency and performance, the rectifier (D1) should be a fast low capacitance Schottky diode with low reverse leakage at the maximum operating voltage and temperature. The recommended diode for use with this part is the ZLLS1000. This has approximately ten times lower leakage than standard Schottky diodes, which are unsuitable for use above 85°C. It also provides better efficiency than silicon diodes, due to a combination of lower forward voltage and reduced recovery time.

The table below gives the typical characteristics for the ZLLS1000:

Diode	Forward Voltage at 100mA (mV)	Continuous Current (mA)	Reverse Leakage At 30V 85°C (µA)	Package
ZLLS1000	310	1000	300	TSOT23-5

If alternative diodes are used, it is important to select parts with a peak current rating above the peak coil current and a continuous current rating higher than the maximum output load current. It is very important to consider the reverse leakage of the diode when operating above 85°C. Excess leakage will increase the power dissipation in the device.

The higher forward voltage and overshoot due to reverse recovery time in silicon diodes will increase the peak voltage on the LX output. If a silicon diode is used, care should be taken to ensure that the total voltage appearing on the LX pin including supply ripple, does not exceed the specified maximum value.

Application Information (Continued)

Reducing Output Ripple

Peak to peak ripple current in the LED can be reduced, if required, by shunting a capacitor C_{led} across the LED(s) as shown below:

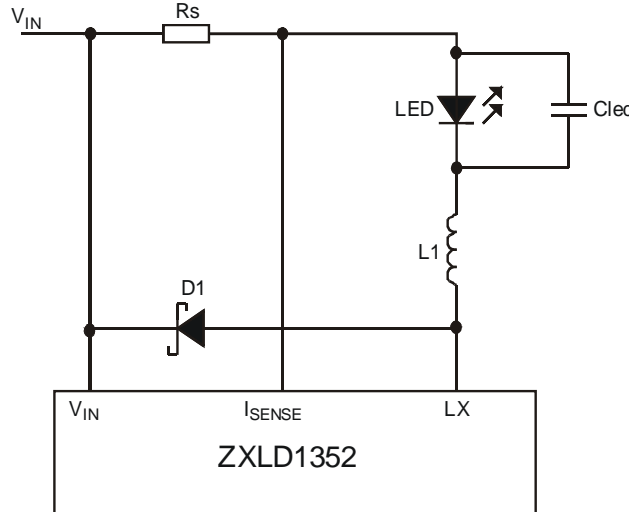

A value of $1\mu F$ will reduce nominal ripple current by a factor three (approx.). Proportionally lower ripple can be achieved with higher capacitor values. Note that the capacitor will not affect operating frequency or efficiency, but it will increase start-up delay, by reducing the rate of rise of LED voltage.

Operation at low supply voltage

The internal regulator disables the drive to the switch until the supply has risen above the start-up threshold (V_{SU}). Above this threshold, the device will start to operate. However, with the supply voltage below the specified minimum value, the switch duty cycle will be high and the device power dissipation will be at a maximum. Care should be taken to avoid operating the device under such conditions in the application, in order to minimize the risk of exceeding the maximum allowed die temperature. (See next section on thermal considerations).

Note that when driving loads of two or more LEDs, the forward drop will normally be sufficient to prevent the device from switching below approximately 6V. This will minimize the risk of damage to the device.

Thermal considerations

When operating the device at high ambient temperatures, or when driving maximum load current, care must be taken to avoid exceeding the package power dissipation limits. The graph below gives details for power derating. This assumes the device to be mounted on a $25mm^2$ PCB with 1oz copper standing in still air.

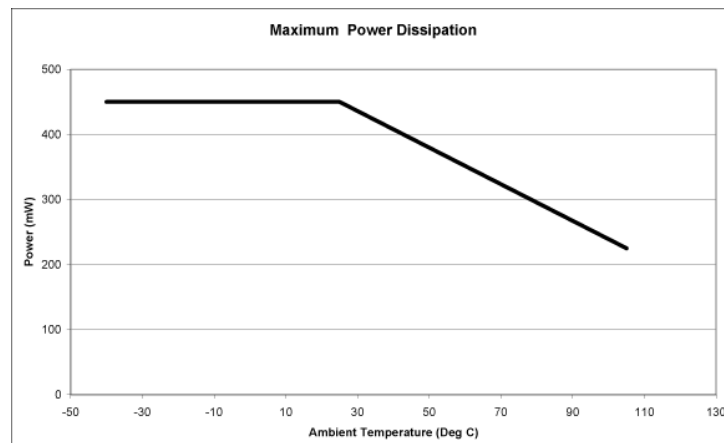

Application Information (Continued)

Note that the device power dissipation will most often be a maximum at **minimum** supply voltage. It will also increase if the efficiency of the circuit is low. This may result from the use of unsuitable coils, or excessive parasitic output capacitance on the switch output.

Thermal compensation of output current

High luminance LEDs often need to be supplied with a temperature compensated current in order to maintain stable and reliable operation at all drive levels. The LEDs are usually mounted remotely from the device, so for this reason, the temperature coefficients of the internal circuits for the ZXLD1352 have been optimized to minimize the change in output current when no compensation is employed. If output current compensation is required, it is possible to use an external temperature sensing network - normally using Negative Temperature Coefficient (NTC) thermistors and/or diodes, mounted very close to the LED(s). The output of the sensing network can be used to drive the ADJ pin in order to reduce output current with increasing temperature.

Layout considerations

LX pin

The LX pin of the device is a fast switching node, so PCB tracks should be kept as short as possible. To minimize ground 'bounce', the ground pin of the device should be soldered directly to the ground plane.

Coil and decoupling capacitors

It is particularly important to mount the coil and the input decoupling capacitor close to the device to minimize parasitic resistance and inductance, which will degrade efficiency. It is also important to take account of any track resistance in series with current sense resistor R_S .

ADJ pin

The ADJ pin is a high impedance input, so when left floating, PCB tracks to this pin should be as short as possible to reduce noise pickup. A 100nF capacitor from the ADJ pin to ground will reduce frequency modulation of the output under these conditions. An additional series 10k Ω resistor can also be used when driving the ADJ pin from an external circuit (see below). This resistor will provide filtering for low frequency noise and provide protection against high voltage transients.

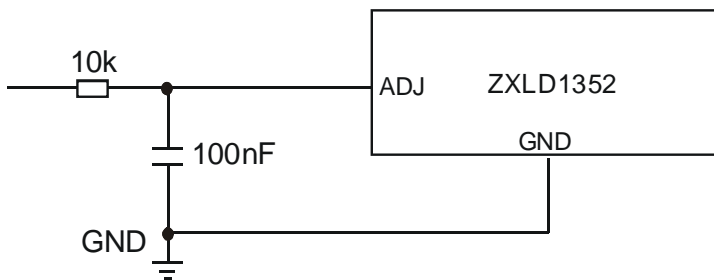

High voltage tracks

Avoid running any high voltage tracks close to the ADJ pin, to reduce the risk of leakage due to board contamination. Any such leakage may raise the ADJ pin voltage and cause excessive output current. A ground ring placed around the ADJ pin will minimize changes in output current under these conditions.

Dimming Output Current Using PWM

When the ADJ pin is driven with a low frequency PWM signal (eg 100Hz), with a high level voltage V_{ADJ} and a low level of zero, the output current will be switched on and off at the PWM frequency, resulting in an average output current I_{OUTavg} proportional to the PWM duty cycle. (See Figure 2)

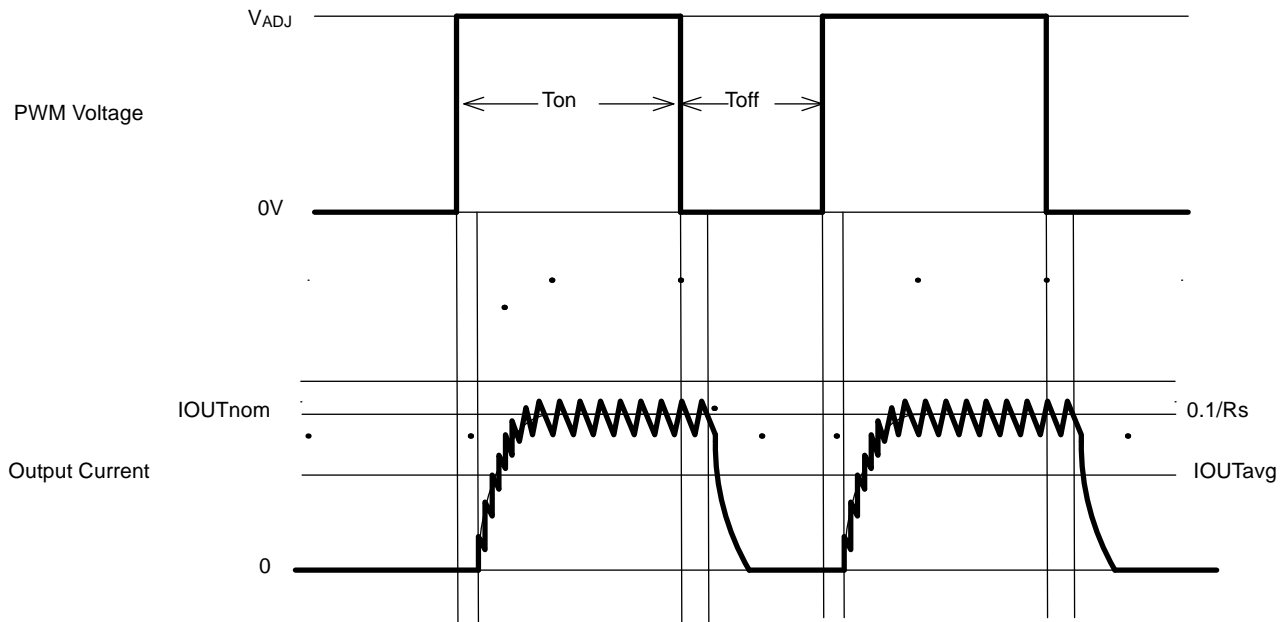

Figure 3. Low Frequency PWM Operating Waveforms

The average value of output current in this mode is given by:

The average value of output current is given by:

$$I_{OUTavg} = 0.1D_{PWM}/R_S \quad \text{for } D_{PWM} > 0.01$$

PWM dimming is preferable to DC dimming if optimum LED 'whiteness' is required. It will also provide the widest possible dimming range (approx. 1000:1) and higher efficiency at the expense of greater output ripple.

Ordering Information

Device	Package	Reel Size (mm)	Tape Width (mm)	Quantity (per reel)	Part Marking
ZXLD1352ET5TA	TSOT23-5	180	8	3000	1352

Package Outline Dimensions

TSOT23-5

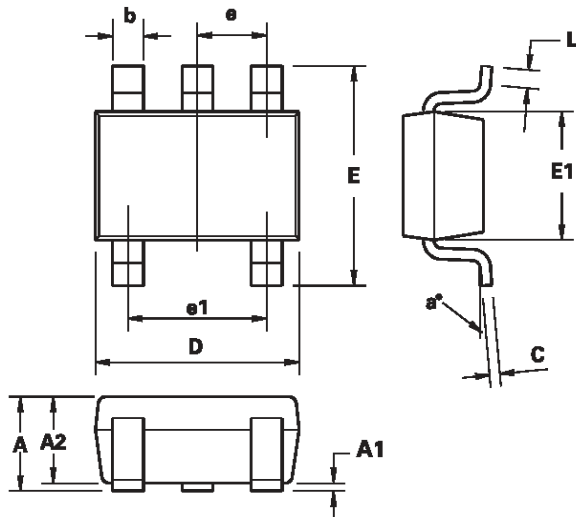

DIM	Millimeters		Inches	
	Min.	Max.	Min.	Max.
A	0.90	1.45	0.0354	0.0570
A1	0.00	0.15	0.00	0.0059
A2	0.90	1.30	0.0354	0.0511
b	0.20	0.50	0.0078	0.0196
C	0.09	0.26	0.0035	0.0102
D	2.70	3.10	0.1062	0.1220
E	2.20	3.20	0.0866	0.1181
E1	1.30	1.80	0.0511	0.0708
e	0.95 REF		0.0374 REF	
e1	1.90 REF		0.0748 REF	
L	0.10	0.60	0.0039	0.0236
a°	0°	30°	0°	30°

Note: Controlling dimensions are in millimeters. Approximate dimensions are provided in inches

IMPORTANT NOTICE

DIODES INCORPORATED MAKES NO WARRANTY OF ANY KIND, EXPRESS OR IMPLIED, WITH REGARDS TO THIS DOCUMENT, INCLUDING, BUT NOT LIMITED TO, THE IMPLIED WARRANTIES OF MERCHANTABILITY AND FITNESS FOR A PARTICULAR PURPOSE (AND THEIR EQUIVALENTS UNDER THE LAWS OF ANY JURISDICTION).

Diodes Incorporated and its subsidiaries reserve the right to make modifications, enhancements, improvements, corrections or other changes without further notice to this document and any product described herein. Diodes Incorporated does not assume any liability arising out of the application or use of this document or any product described herein; neither does Diodes Incorporated convey any license under its patent or trademark rights, nor the rights of others. Any Customer or user of this document or products described herein in such applications shall assume all risks of such use and will agree to hold Diodes Incorporated and all the companies whose products are represented on Diodes Incorporated website, harmless against all damages.

Diodes Incorporated does not warrant or accept any liability whatsoever in respect of any products purchased through unauthorized sales channel.

Should Customers purchase or use Diodes Incorporated products for any unintended or unauthorized application, Customers shall indemnify and hold Diodes Incorporated and its representatives harmless against all claims, damages, expenses, and attorney fees arising out of, directly or indirectly, any claim of personal injury or death associated with such unintended or unauthorized application.

Products described herein may be covered by one or more United States, international or foreign patents pending. Product names and markings noted herein may also be covered by one or more United States, international or foreign trademarks.

LIFE SUPPORT

Diodes Incorporated products are specifically not authorized for use as critical components in life support devices or systems without the express written approval of the Chief Executive Officer of Diodes Incorporated. As used herein:

A. Life support devices or systems are devices or systems which:

1. are intended to implant into the body, or
2. support or sustain life and whose failure to perform when properly used in accordance with instructions for use provided in the labeling can be reasonably expected to result in significant injury to the user.

B. A critical component is any component in a life support device or system whose failure to perform can be reasonably expected to cause the failure of the life support device or to affect its safety or effectiveness.

Customers represent that they have all necessary expertise in the safety and regulatory ramifications of their life support devices or systems, and acknowledge and agree that they are solely responsible for all legal, regulatory and safety-related requirements concerning their products and any use of Diodes Incorporated products in such safety-critical, life support devices or systems, notwithstanding any devices- or systems-related information or support that may be provided by Diodes Incorporated. Further, Customers must fully indemnify Diodes Incorporated and its representatives against any damages arising out of the use of Diodes Incorporated products in such safety-critical, life support devices or systems.

Copyright © 2010, Diodes Incorporated

www.diodes.com

Mouser Electronics

Authorized Distributor

Click to View Pricing, Inventory, Delivery & Lifecycle Information:

[Diodes Incorporated:](#)

[ZXLD1352ET5TA](#)