

FILTERLESS 2.5W CLASS-D STEREO AUDIO AMPLIFIER

Description

The PAM8003 is a 2.5W, Class-D audio amplifier. It offers low THD+N, allowing it to achieve high-quality sound reproduction. The new filterless architecture allows the device to drive the speaker directly, requiring no low-pass output filters, thus saving the system cost and PCB area.

With the same numbers of external components, the efficiency of the PAM8003 is much better than that of class-AB cousins. It can extend the battery life, making it ideal for portable applications.

The PAM8003 is available in SO-16 package.

Pin Assignments

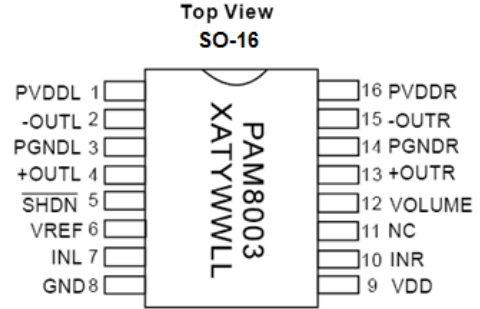

Features

- 2.5W Output at 10% THD with a 5Ω Load and 5V Power Supply
- Filterless, Low Quiescent Current and Low EMI
- Low THD+N
- 64-Step DC Volume Control
- Superior Low Noise
- Short Circuit Protection
- Thermal Shutdown
- Few External Components to Save the Space and Cost
- RoHS Pass and Green Package
- **Totally Lead-Free & Fully RoHS Compliant (Notes 1 & 2)**
- **Halogen and Antimony Free. "Green" Device (Note 3)**

Applications

- LCD Monitors / TVs
- Notebook Computers
- Portable Speakers
- Portable DVD Players, Game Machines

Ordering Information

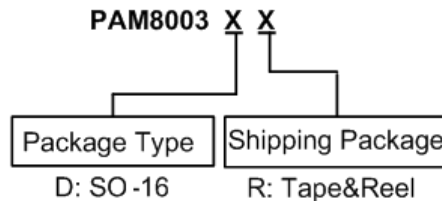

Part Number	Part Marking	Package Type	Standard Package
PAM8003DR	PAM8003 XATYWWLL	SO-16	2,500 Units/Tape & Reel

Notes:

1. No purposely added lead. Fully EU Directive 2002/95/EC (RoHS) & 2011/65/EU (RoHS 2) compliant.
2. See <https://www.diodes.com/quality/lead-free/> for more information about Diodes Incorporated's definitions of Halogen- and Antimony-free, "Green" and Lead-free.
3. Halogen- and Antimony-free "Green" products are defined as those which contain <900ppm bromine, <900ppm chlorine (<1500ppm total Br + Cl) and <1000ppm antimony compounds.

Typical Applications Circuit

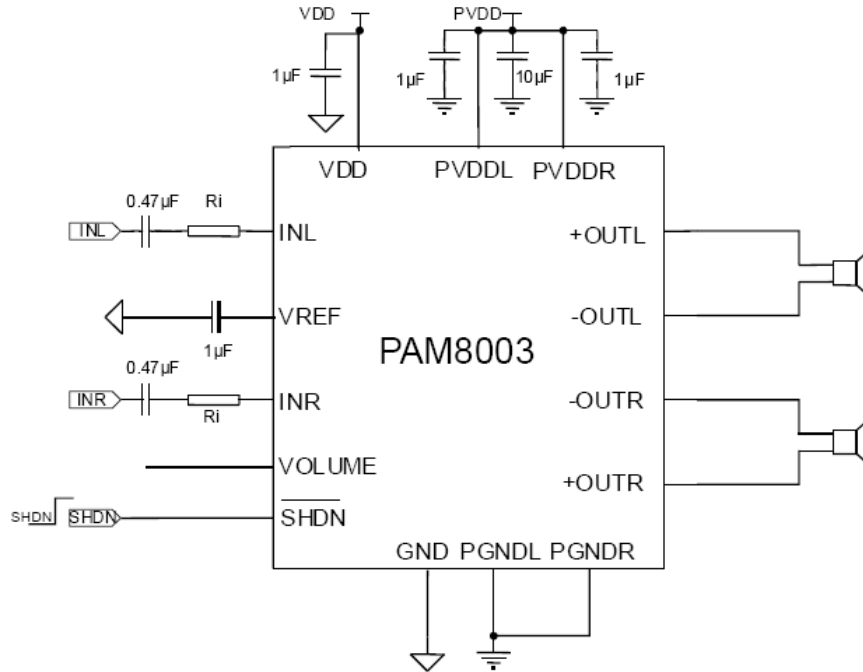

Pin Descriptions

Pin Number	Pin Name	Function
1	PVDDL	Left Channel Power Supply
2	-OUTL	Left Channel Negative Output
3	PGNDL	Left Channel Power GND
4	+OUTL	Left Channel Positive Output
5	SHDN	Shutdown Control Input (active low)
6	VREF	Internal Analog Reference, Connect a Bypass Capacitor from VREF to GND
7	INL	Left Channel Input
8	GND	Analog Ground
9	VDD	Analog Power Supply
10	INR	Right Channel Input
11	NC	Not Connected
12	VOLUME	DC Volume Control to Set the Gain of Class-D
13	+OUTR	Right Channel Positive Output
14	PGNDR	Right Channel Power GND
15	-OUTR	Right Channel Negative Output
16	PVDDR	Right Channel Power Supply

Functional Block Diagram

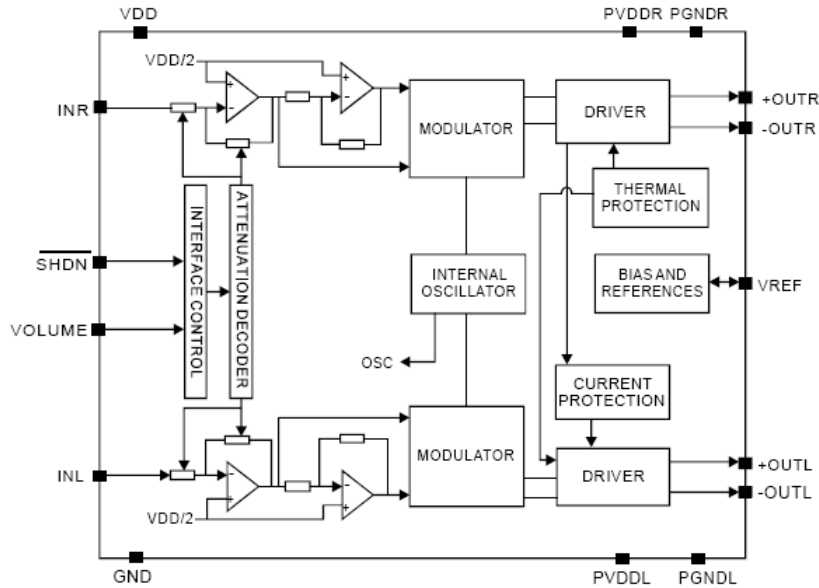

Absolute Maximum Ratings (@T_A = +25°C, unless otherwise specified.)

These are stress ratings only and functional operation is not implied. Exposure to absolute maximum ratings for prolonged time periods may affect device reliability. All voltages are with respect to ground.

Parameter	Rating	Unit
Supply Voltage	6.0	V
Input Voltage	-0.3 to V _{DD} +0.3	
Maximum Junction Temperature	150	°C
Storage Temperature	-65 to +150	
Soldering Temperature	300, 5 sec	

Recommended Operating Conditions (@T_A = +25°C, unless otherwise specified.)

Parameter	Rating	Unit
Supply Voltage Range	2.5 to 5.5	V
Operation Temperature Range	-40 to +85	°C
Junction Temperature Range	-40 to +125	°C

Thermal Information

Parameter	Package	Symbol	Max	Unit
Thermal Resistance (Junction to Ambient)	SO-16	θ _{JA}	110	°C/W
Thermal Resistance (Junction to Case)	SO-16	θ _{JC}	23	

Electrical Characteristics (@T_A = +25°C, V_{DD} = 5V, Gain = 24dB, R_L = 8Ω, unless otherwise specified.)

Symbol	Parameter	Test Conditions		Min	Typ	Max	Units
V _{IN}	Supply Power	-	-	2.5	-	5.5	V
P _O	Output Power	THD+N = 10%, f = 1kHz, R _L = 4Ω	V _{DD} = 5.0V	-	2.5	-	W
		THD+N = 1%, f = 1kHz, R _L = 4Ω	V _{DD} = 5.0V	-	2.2	-	W
		THD+N = 10%, f = 1kHz, R _L = 8Ω	V _{DD} = 5.0V	-	1.65	-	W
		THD+N = 1%, f = 1kHz, R _L = 8Ω	V _{DD} = 5.0V	-	1.3	-	W
THD+N	Total Harmonic Distortion Plus Noise	V _{DD} = 5.0V, P _O = 0.5W, R _L = 8Ω	f = 1kHz	-	0.16	-	%
		V _{DD} = 3.6V, P _O = 0.5W, R _L = 8Ω		-	0.12	-	
		V _{DD} = 5.0V, P _O = 1W, R _L = 4Ω	f = 1kHz	-	0.17	-	%
		V _{DD} = 3.6V, P _O = 1W, R _L = 4Ω		-	0.26	-	
PSRR	Power Supply Ripple Rejection	V _{DD} = 5.0V, Inputs AC-Grounded with C _{IN} = 0.47μF, G _V = 6dB	f = 1kHz	-	-70	-	dB
C _S	Crosstalk	V _{DD} = 5V, P _O = 0.5W, R _L = 8Ω, G _V = 20dB	f = 1kHz	-	-93	-	dB
SNR	Signal-to-Noise	V _{DD} = 5V, G _V = 6dB	f = 1kHz	-	86	-	dB
V _N	Output Noise	V _{DD} = 5V, Inputs AC-Grounded with C _{IN} = 0.47μF, G _V = 6dB	A-weighting	-	33	-	μV
			No A-weighting	-	50	-	
η	Efficiency	R _L = 8Ω, THD = 10%	f = 1kHz	-	87	-	%
		R _L = 4Ω, THD = 10%		-	79	-	
I _Q	Quiescent Current	V _{DD} = 5.0V	No load	-	4.5	7.0	mA
		V _{DD} = 3.6V		-	4.0	6.5	
		V _{DD} = 3.0V		-	3.7	5.5	
I _{SD}	Shutdown Current	V _{DD} = 2.5V to 5.5V	-	-	-	1	μA
R _{DS(ON)}	Static Drain-to-Source On-State Resistor	I _{DS} = 500mA, V _{GS} = 5V	PMOS	-	0.41	-	mΩ
			NMOS	-	0.27	-	
f _{sw}	Switching Frequency	V _{DD} = 3V to 5V	-	-	210	-	kHz
V _{OS}	Output Offset Voltage	V _{IN} = 0V, V _{DD} = 5V	-	-	10	-	mV
V _{IH}	Enable Input High Voltage	V _{DD} = 5.0V	-	1.5	-	-	V
V _{IL}	Enable Input Low Voltage	V _{DD} = 5.0V	-	-	-	0.4	
OTP	Over-temperature Protection	No Load, Junction Temperature	V _{DD} = 5V	-	150	-	°C
OTH	Over-temperature Hysteresis			-	30	-	

Typical Performance Characteristics (@ $T_A = +25^\circ\text{C}$, unless otherwise specified.)

1. THD+N vs Output Power

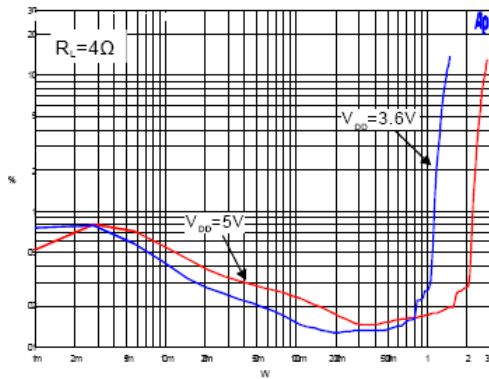

2. THD+N vs Output Power

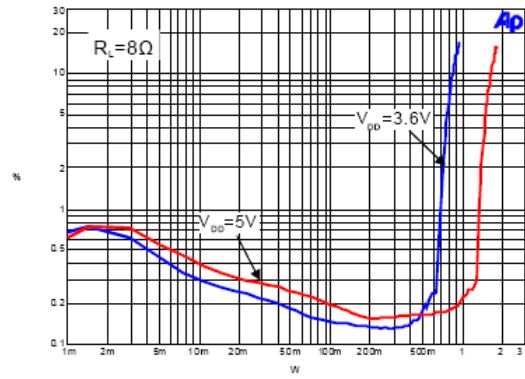

3. THD+N vs Frequency

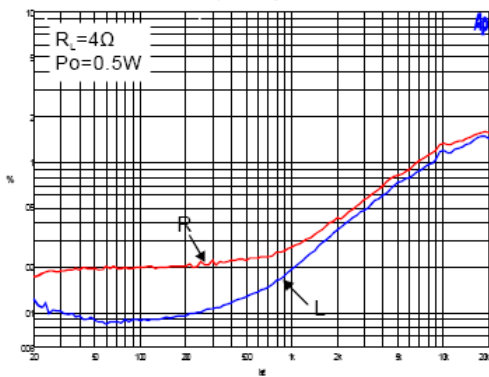

4. THD+N vs Frequency

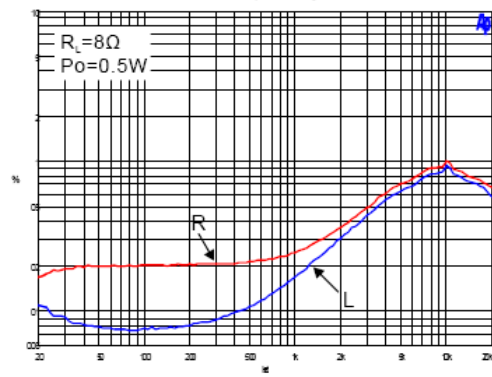

5. Frequency Response

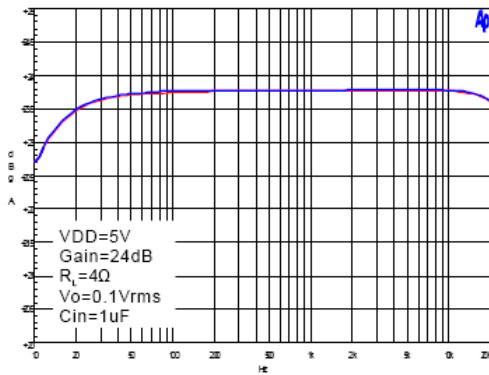

6. Crosstalk

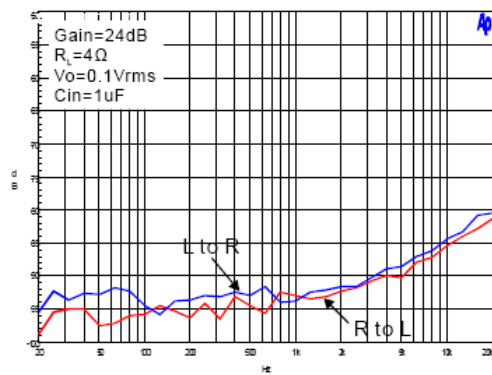

Typical Performance Characteristics (continued) (@T_A = +25°C, unless otherwise specified.)

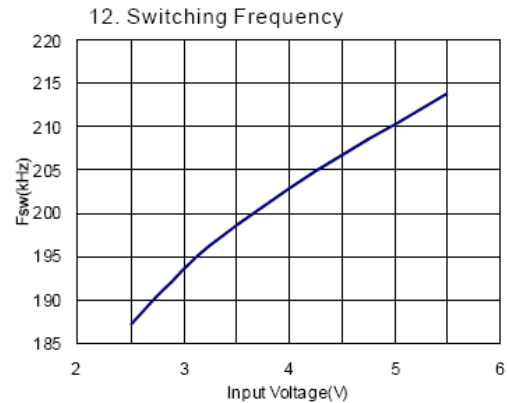
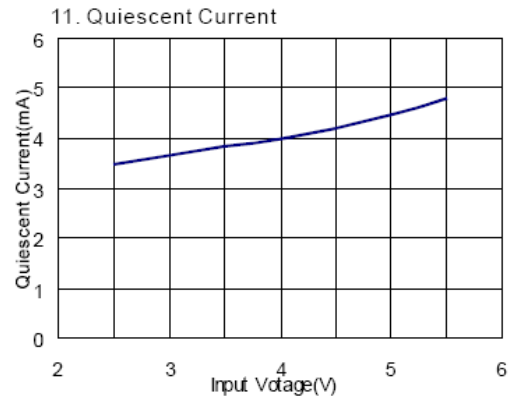
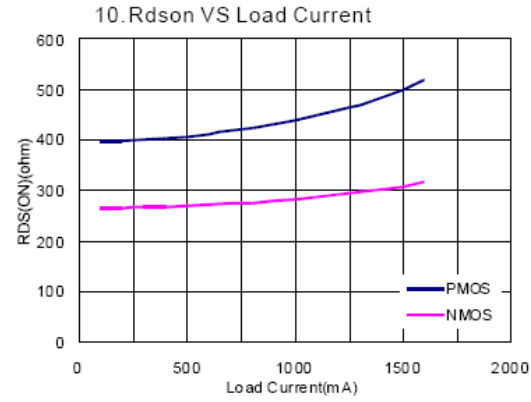
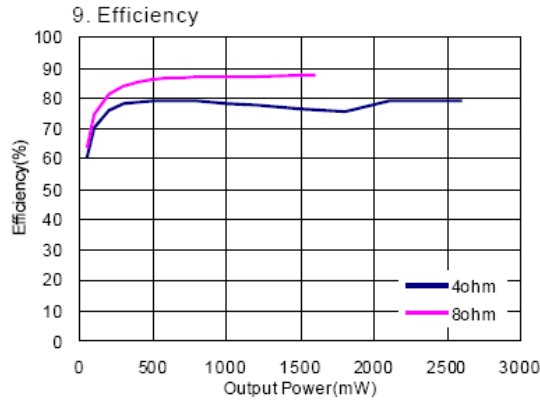
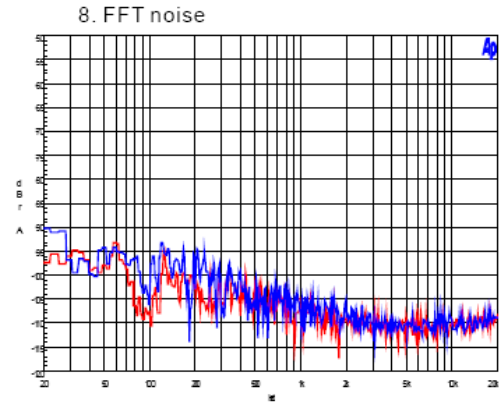
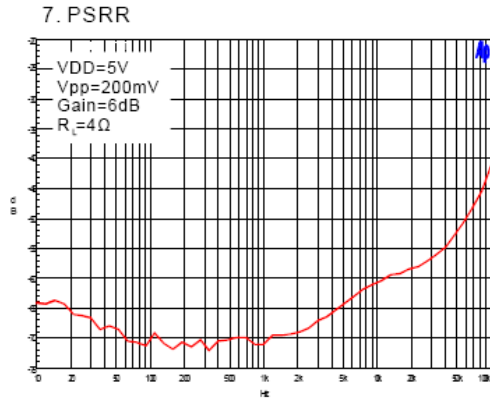

Typical Performance Characteristics (cont.) (@T_A = +25°C, unless otherwise specified.)

STEP	Gain (dB)		STEP	Gain (dB)
0	-75		32	11.6
1	-40		33	12.0
2	-34		34	12.4
3	-28		35	12.8
4	-22		36	13.2
5	-16		37	13.6
6	-10		38	14.0
7	-7.5		39	14.4
8	-5		40	14.8
9	-2.5		41	15.2
10	0		42	15.6
11	1.5		43	16.0
12	3.0		44	16.4
13	4.0		45	16.8
14	4.4		46	17.2
15	4.8		47	17.6
16	5.2		48	18.0
17	5.6		49	18.4
18	6.0		50	18.8
19	6.4		51	19.2
20	6.8		52	19.6
21	7.2		53	20.0
22	7.6		54	20.4
23	8.0		55	20.8
24	8.4		56	21.2
25	8.8		57	21.6
26	9.2		58	22.0
27	9.6		59	22.4
28	10.0		60	22.8
29	10.4		61	23.2
30	10.8		62	23.6
31	11.2		63	24.0

Application Information

1. When the PAM8803 works with LC filters, it should be connected with the speaker before it's powered on, otherwise it will risk being damaged easily.
2. When the PAM8003 works without LC filters, it's better to add a ferrite chip bead at the outgoing line of speaker for suppressing the possible electromagnetic interference.
3. The recommended operating voltage is 5.5V. When the PAM8003 is powered with four battery cells, it should be noted that the voltage of four new dry or alkaline batteries is over 6.0V, higher than its operation voltage, which will probably damage the device. Therefore, it's recommended to use either four Ni-MH (Nickel Metal Hydride) rechargeable batteries or three dry or alkaline batteries.
4. One should not make the input signal too large. Large signal can cause the clipping of output signal when increasing the volume. This will damage the device because of big gain of the PAM8004.
5. When testing the PAM8803 without LC filters by using resistor instead of speakers as the output load, the test results, e.g. THD or efficiency, will be worse than those of using speaker as load.

Test Setup for Performance Testing

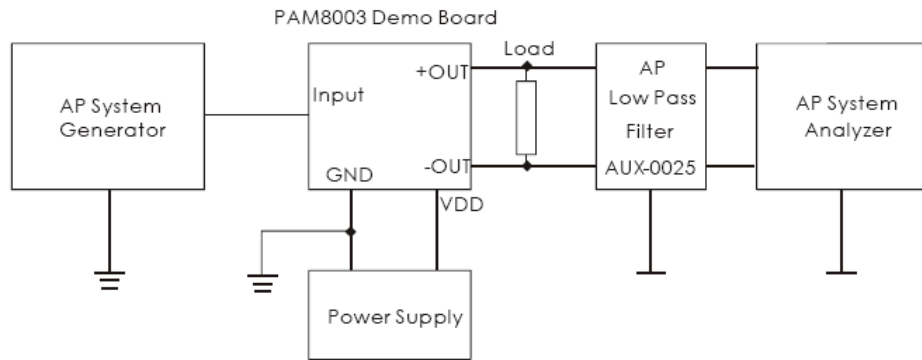

- Notes:
4. The AP AUX-0025 low pass filter is necessary for class-D amplifier measurement with AP analyzer.
 5. Two 22μH inductors are used in series with load resistor to emulate the small speaker for efficiency measurement.

Power Supply Decoupling

The PAM8003 is a high-performance CMOS audio amplifier that requires adequate power supply decoupling to ensure the output THD and PSRR as low as possible. Power supply decoupling affects low frequency response. Optimum decoupling is achieved by using two capacitors of different types of noise on the power supply leads. For higher frequency transients, spikes, or digital hash on the line, a good low equivalent-series-resistance (ESR) ceramic capacitor, typically 1.0μF, works best, placing it as close as possible to the device V_{DD} terminal. For filtering lower-frequency noise signals, a large capacitor of 20μF (ceramic) or greater is recommended, placing it near the audio power amplifier.

Input Capacitor (C_I)

Large input capacitors are both expensive and space hungry for portable designs. Clearly, a certain sized capacitor is needed to couple in low frequencies without severe attenuation. But in many cases the speakers used in portable systems, whether internal or external, have little ability to reproduce signals below 100Hz to 150Hz. Thus, using a large input capacitor may not increase actual system performance. In this case, input capacitor (C_I) and input resistance (R_I) of the amplifier form a high-pass filter with the corner frequency determined by equation below.

In addition to system cost and size, click and pop performance is affected by the size of the input the coupling capacitor, C_I. A larger input coupling capacitor requires more charge to reach its quiescent DC voltage (nominally ½ V_{DD}). This charge comes from the internal circuit via the feedback and is apt to create pops upon device enable. Thus, by minimizing the capacitor size based on necessary low frequency response, turn-on pops can be minimized.

$$f_c = \frac{1}{2\pi R_I C_I}$$

Application Information (continued)

Analog Reference Bypass Capacitor (C_{BYP})

The Analog Reference Bypass Capacitor (C_{BYP}) is the most critical capacitor and serves several important functions. During start-up or recovery from shutdown mode, C_{BYP} determines the rate at which the amplifier starts up. The second function is to reduce noise caused by the power supply coupling into the output drive signal. This noise is from the internal analog reference to the amplifier, which appears as degraded PSRR and THD+N.

A ceramic bypass capacitor (C_{BYP}) with values of 0.1μF to 1.0μF is recommended for the best THD and noise performance. Increasing the bypass capacitor reduces clicking and popping noise from power on/off and entering and leaving shutdown.

Undervoltage Lock-Out (UVLO)

The PAM8003 incorporates circuitry designed to detect low supply voltage. When the supply voltage drops to 2.0V or below, the PAM8003 outputs are disabled, and the device comes out of this state and starts to normal function when V_{DD} ≥ 2.2V.

Short Circuit Protection (SCP)

The PAM8003 has short circuit protection circuitry on the outputs to prevent damage to the device when output-to-output or output-to-GND short occurs. When a short circuit is detected on the outputs, the outputs are disabled immediately. If the short was removed, the device activates again.

Over-temperature Protection

Thermal protection on the PAM8003 prevents the device from damage when the internal die temperature exceeds +140°C. There is a 15° tolerance on this trip point from device to device. Once the die temperature exceeds the thermal set point, the device outputs are disabled. This is not a latched fault. The thermal fault is cleared once the temperature of the die is reduced by 30°C. This large hysteresis will prevent motor boating sound well and the device begins normal operation at this point without external system intervention.

How to Reduce EMI (Electro Magnetic Interference)

A simple solution is to put an additional capacitor 1000μF at power supply terminal for power line coupling if the traces from amplifier to speakers are short (< 20cm).

Most applications require a ferrite bead filter as shown in Figure 2. The ferrite filter reduces EMI of around 1 MHz and higher. When selecting a ferrite bead, choose one with high impedance at high frequencies, and low impedance at low frequencies.

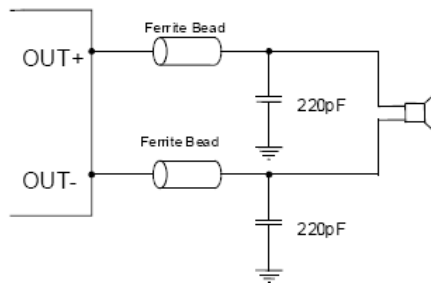
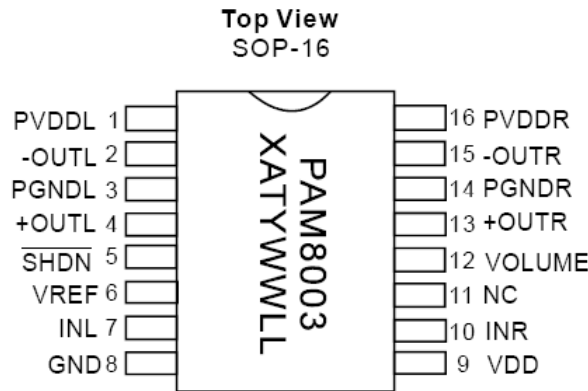

Figure 2. Ferrite Bead Filter to Reduce EMI

Marking Information



X: Internal Code
A: Assembly Code
T: Testing Code
Y: Year
WW: Week
LL: Internal Code

Package Outline Dimensions

Please see <http://www.diodes.com/package-outlines.html> for the latest version.

SO-16

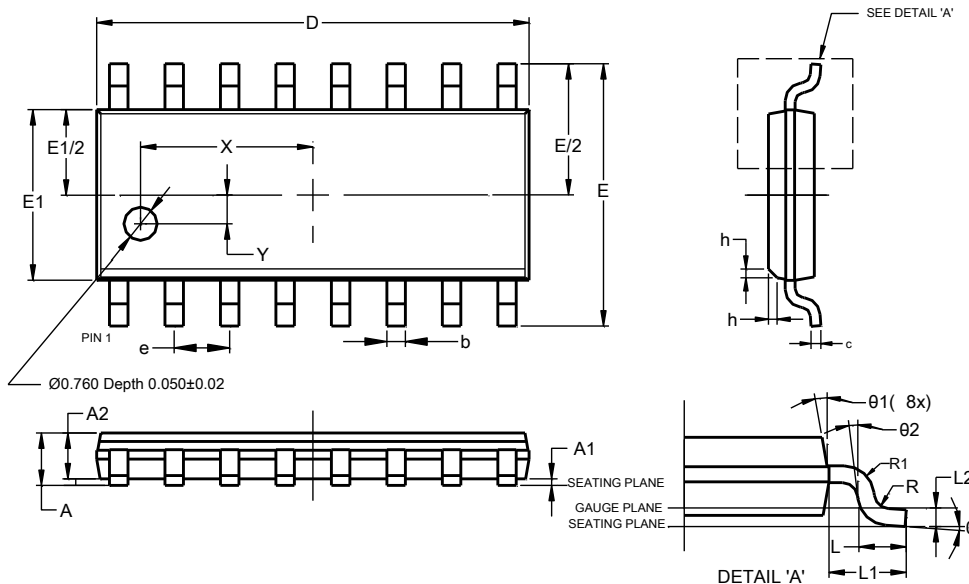

SO-16			
Dim	Min	Max	Typ
A	--	1.260	--
A1	0.10	0.23	--
A2	1.02	--	--
b	0.31	0.51	--
c	0.10	0.25	--
D	9.80	10.00	--
E	5.90	6.10	--
E1	3.80	4.00	--
e	1.27 BSC		
h	0.15	0.25	0.20
L	0.40	1.27	--
L1	1.04 REF		
L2	0.25 BSC		
R	0.07	--	--
R1	0.07	--	--
X	3.945 REF		
Y	0.661 REF		
θ	0°	8°	--
$\theta 1$	5°	15°	--
$\theta 2$	0°	--	--
All Dimensions in mm			

Suggested Pad Layout

Please see <http://www.diodes.com/package-outlines.html> for the latest version.

SO-16

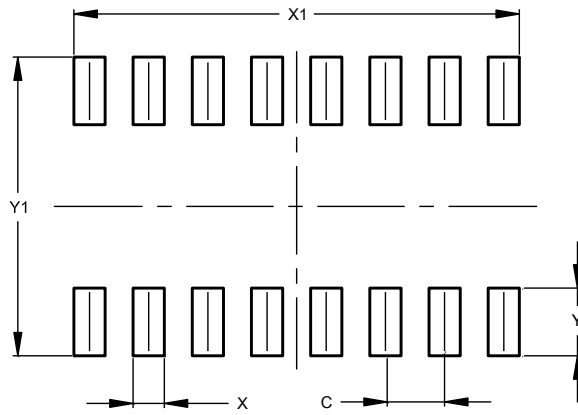

Dimensions	Value (in mm)
C	1.270
X	0.670
X1	9.560
Y	1.450
Y1	6.400

IMPORTANT NOTICE

DIODES INCORPORATED MAKES NO WARRANTY OF ANY KIND, EXPRESS OR IMPLIED, WITH REGARDS TO THIS DOCUMENT, INCLUDING, BUT NOT LIMITED TO, THE IMPLIED WARRANTIES OF MERCHANTABILITY AND FITNESS FOR A PARTICULAR PURPOSE (AND THEIR EQUIVALENTS UNDER THE LAWS OF ANY JURISDICTION).

Diodes Incorporated and its subsidiaries reserve the right to make modifications, enhancements, improvements, corrections or other changes without further notice to this document and any product described herein. Diodes Incorporated does not assume any liability arising out of the application or use of this document or any product described herein; neither does Diodes Incorporated convey any license under its patent or trademark rights, nor the rights of others. Any Customer or user of this document or products described herein in such applications shall assume all risks of such use and will agree to hold Diodes Incorporated and all the companies whose products are represented on Diodes Incorporated website, harmless against all damages.

Diodes Incorporated does not warrant or accept any liability whatsoever in respect of any products purchased through unauthorized sales channel. Should Customers purchase or use Diodes Incorporated products for any unintended or unauthorized application, Customers shall indemnify and hold Diodes Incorporated and its representatives harmless against all claims, damages, expenses, and attorney fees arising out of, directly or indirectly, any claim of personal injury or death associated with such unintended or unauthorized application.

Products described herein may be covered by one or more United States, international or foreign patents pending. Product names and markings noted herein may also be covered by one or more United States, international or foreign trademarks.

This document is written in English but may be translated into multiple languages for reference. Only the English version of this document is the final and determinative format released by Diodes Incorporated.

LIFE SUPPORT

Diodes Incorporated products are specifically not authorized for use as critical components in life support devices or systems without the express written approval of the Chief Executive Officer of Diodes Incorporated. As used herein:

A. Life support devices or systems are devices or systems which:

1. are intended to implant into the body, or
2. support or sustain life and whose failure to perform when properly used in accordance with instructions for use provided in the labeling can be reasonably expected to result in significant injury to the user.

B. A critical component is any component in a life support device or system whose failure to perform can be reasonably expected to cause the failure of the life support device or to affect its safety or effectiveness.

Customers represent that they have all necessary expertise in the safety and regulatory ramifications of their life support devices or systems, and acknowledge and agree that they are solely responsible for all legal, regulatory and safety-related requirements concerning their products and any use of Diodes Incorporated products in such safety-critical, life support devices or systems, notwithstanding any devices- or systems-related information or support that may be provided by Diodes Incorporated. Further, Customers must fully indemnify Diodes Incorporated and its representatives against any damages arising out of the use of Diodes Incorporated products in such safety-critical, life support devices or systems.

Copyright © 2017, Diodes Incorporated

www.diodes.com

Mouser Electronics

Authorized Distributor

Click to View Pricing, Inventory, Delivery & Lifecycle Information:

[Diodes Incorporated:](#)

[PAM8003DR](#)