

1.1MHz, 800mA SYNCHRONOUS DC-DC BUCK CONVERTER AP3406A

General Description

The AP3406A is a 1.1MHz fixed frequency, current mode, PWM synchronous buck (step-down) DC-DC converter, capable of driving a 800mA load with high efficiency, excellent line and load regulation. The device integrates a main switch and a synchronous switch without an external Schottky diode. It is ideal for powering portable equipment that runs from a single Li-ion battery.

A standard series of inductors are available from several different manufacturers optimized for use with the AP3406A. This feature greatly simplifies the design of switch-mode power supplies.

This IC is available in TSOT-23-5, MSOP-10 and DFN-2×2-6(1) packages.

Features

- High Efficiency: up to 95%
- Output Current: 800mA
- Input Voltage Range: 2.5V to 5.5V
- Fixed 1.1MHz Frequency
- Current Mode Control
- 100% Duty Cycle in Dropout
- Built-in Short Circuit Protection
- Built-in Thermal Shutdown Function
- Built-in Current Limit Function
- Shutdown Current: <math><1\mu\text{A}</math>

Applications

- GPS
- WiFi Card
- Portable Media Player
- Digital Still and Video Cameras

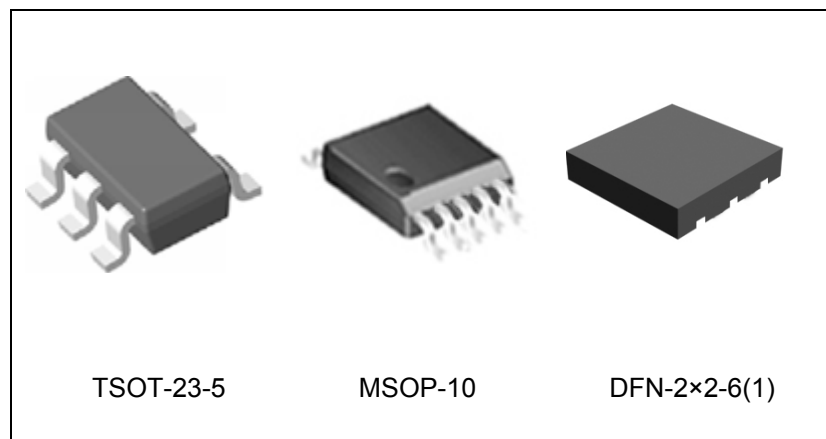

Figure 1. Package Types of AP3406A

1.1MHz, 800mA SYNCHRONOUS DC-DC BUCK CONVERTER AP3406A
Pin Configuration

Figure 2. Pin Configuration of AP3406A (Top View)

Pin Description

Pin Number			Pin Name	Function
TSOT-23-5	MSOP-10	DFN-2×2-6(1)		
1	8	2	EN	Control input pin. Forcing this pin above 1.5V enables the IC. Forcing this pin below 0.6V shuts down the IC. When the IC is in shutdown mode, all functions are disabled to decrease the supply current below 1μA
2	3	5	GND	Ground pin
3	9	4	SW	Power switch output pin. Inductor connection to drain of the internal PFET and NFET switches
4	1	3	VIN	Supply input pin. Bypass to GND with a 10μF or greater ceramic capacitor
5	5	6	FB	Feedback pin. Connect it with an external resistor divider network to program the system output voltage
	2, 4, 6, 7	1	NC	No connection
	10		PGND	Power ground pin

1.1MHz, 800mA SYNCHRONOUS DC-DC BUCK CONVERTER AP3406A

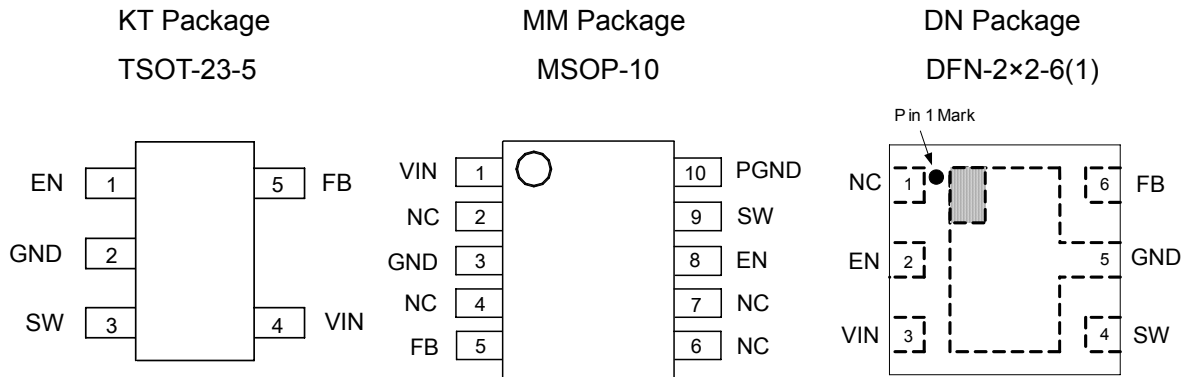
Functional Block Diagram

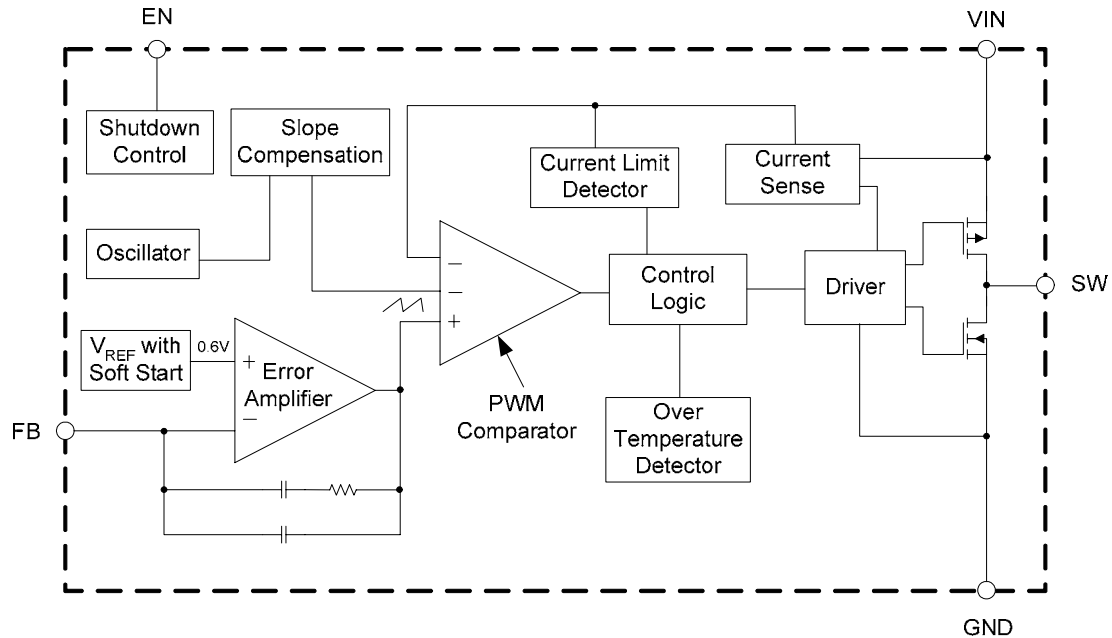
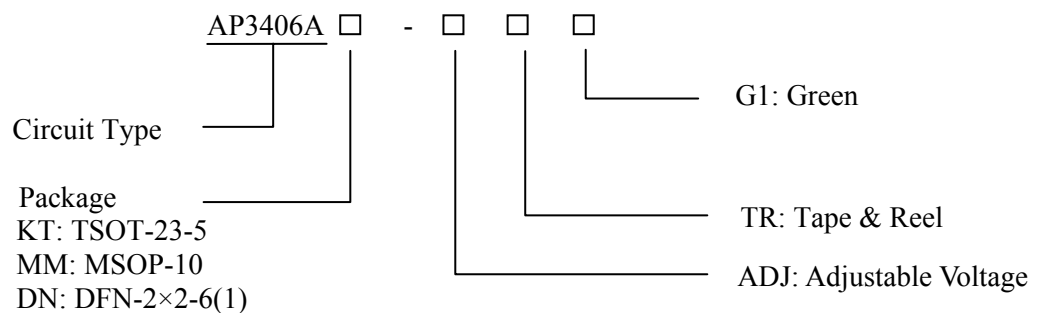

Figure 3. Functional Block Diagram of AP3406A

Ordering Information



Package	Temperature Range	Part Number	Marking ID	Packing Type
TSOT-23-5	-40 to 85°C	AP3406AKT-ADJTRG1	L2A	Tape & Reel
MSOP-10		AP3406AMM-ADJTRG1	3406AMM-G1	Tape & Reel
DFN-2×2-6(1)		AP3406ADN-ADJTRG1	BA	Tape & Reel

BCD Semiconductor's Pb-free products, as designated with "G1" suffix in the part number, are RoHS compliant and green.

**1.1MHz, 800mA SYNCHRONOUS DC-DC BUCK CONVERTER AP3406A****Absolute Maximum Ratings (Note 1)**

Parameter	Symbol	Value		Unit
Input Voltage	V_{IN}	-0.3 to 6		V
Feedback Voltage	V_{FB}	-0.3 to $V_{IN} + 0.3$		V
EN Pin Voltage	V_{EN}	-0.3 to $V_{IN} + 0.3$		V
SW Pin Voltage	V_{SW}	-0.3 to $V_{IN} + 0.3$		V
Thermal Resistance	θ_{JA}	TSOT-23-5	250	°C/W
		MSOP-10	135	
		DFN-2×2-6(1)	100	
Operating Junction Temperature	T_J	150		°C
Storage Temperature	T_{STG}	-65 to 150		°C
Lead Temperature (Soldering, 10sec)	T_{LEAD}	260		°C

Note 1: Stresses greater than those listed under “Absolute Maximum Ratings” may cause permanent damage to the device. These are stress ratings only, and functional operation of the device at these or any other conditions beyond those indicated under “Recommended Operating Conditions” is not implied. Exposure to “Absolute Maximum Ratings” for extended periods may affect device reliability.

Recommended Operating Conditions

Parameter	Symbol	Min	Max	Unit
Input Voltage	V_{IN}	2.5	5.5	V
Maximum Output Current	$I_{OUT(MAX)}$	800		mA
Operating Ambient Temperature	T_A	-40	85	°C



1.1MHz, 800mA SYNCHRONOUS DC-DC BUCK CONVERTER AP3406A

Electrical Characteristics

$V_{IN}=V_{EN}=3.6V$, $T_A=25^{\circ}C$, unless otherwise specified. Specifications with **boldface type** apply over full operating temperature range from -40 to $85^{\circ}C$.

Parameters	Symbol	Conditions	Min	Typ	Max	Unit
Supply Current	I_{CC}	$V_{FB}=0.55V$		400	600	μA
Shutdown Supply Current	I_{SHDN}	$V_{EN}=0V$, $V_{IN}=5.5V$		0.01	1	μA
Under Voltage Lockout Threshold	V_{UVLO}	Rising edge		2.27		V
Under Voltage Lockout Hysteresis	V_{HUVLO}			200		mV
Feedback Bias Current	I_{FB}	$V_{FB}=0.65V$	-50	0.5	50	nA
Feedback Voltage	V_{FB}	$I_{OUT}=100mA$	0.588/ 0.582	0.600	0.612/ 0.618	V
Maximum Output Current	$I_{OUT(MAX)}$	$V_{IN}=2.5V$, $V_{OUT}=0.9V$	800			mA
		$V_{IN}=3.6V$, $V_{OUT}=1.2V$	800			
		$V_{IN}=4.6V$, $V_{OUT}=3.3V$	800			
Switch Current Limit	I_{LIM}	$V_{FB}=0.55V$	0.95	1.25		A
Oscillator Frequency	f_{OSC}		0.8	1.1	1.4	MHz
EN Pin Threshold	V_{ENL}				0.6	V
	V_{ENH}		1.5			
EN Pin Input Leakage Current	I_H	$V_{EN}=3.6V$	-0.1		0.1	μA
	I_L	$V_{EN}=0V$	-0.1		0.1	μA
Internal PFET On Resistance	R_{DSONP}	$I_{SW}=100mA$		0.44		Ω
Internal NFET On Resistance	R_{DSONN}	$I_{SW}=-100mA$		0.29		Ω
Maximum Duty Cycle	D_{MAX}	$V_{FB}=0.55V$		100		%
Soft-start Time	T_{SS}	$V_{EN}=0V$ to V_{IN} $I_{OUT}=50mA$		220		μs
Thermal Shutdown Threshold	T_{OTSD}			160		$^{\circ}C$
Thermal Shutdown Hysteresis	T_{HYS}			30		$^{\circ}C$

1.1MHz, 800mA SYNCHRONOUS DC-DC BUCK CONVERTER AP3406A

Typical Performance Characteristics

$L=10\mu\text{H}$, $C_{\text{IN}}=C_{\text{OUT}}=10\mu\text{F}$, $T_A=25^\circ\text{C}$, unless otherwise noted.

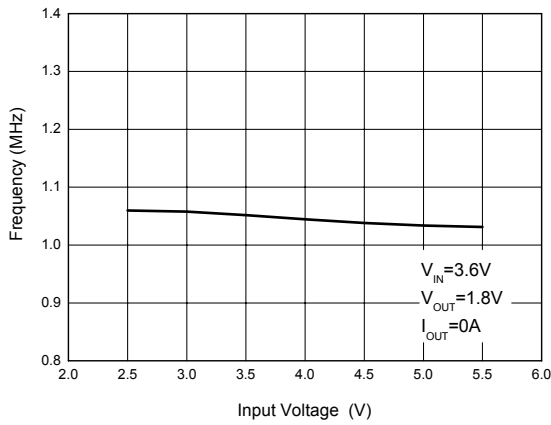

Figure 4. Frequency vs. Input Voltage

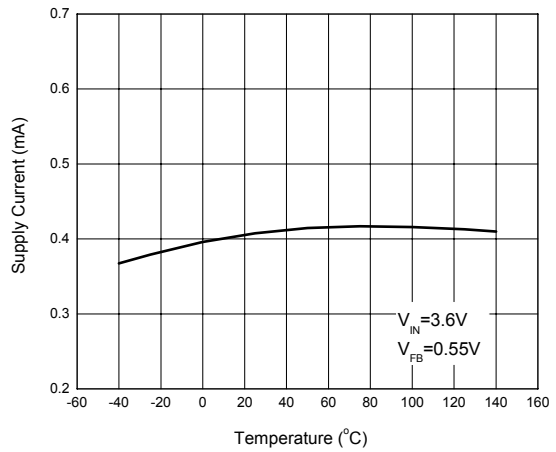

Figure 5. Supply Current vs. Temperature

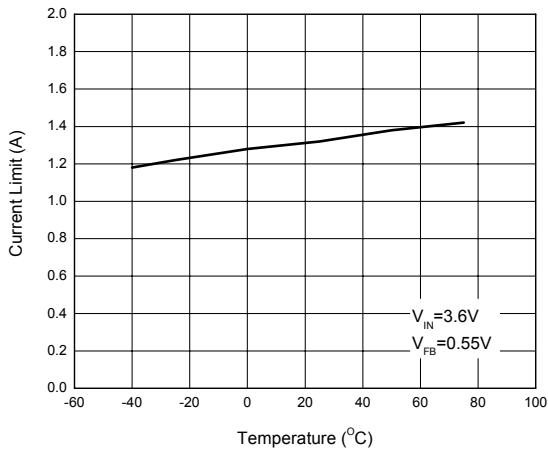

Figure 6. Current Limit vs. Temperature

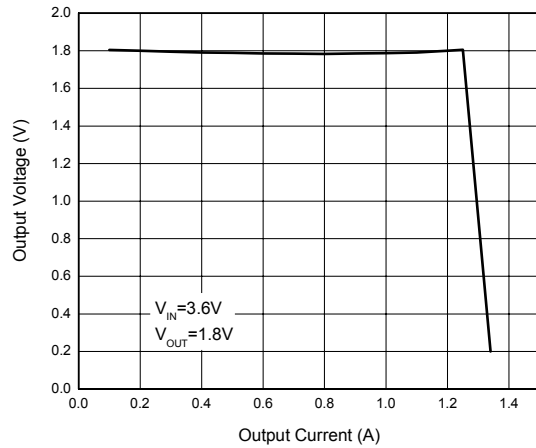
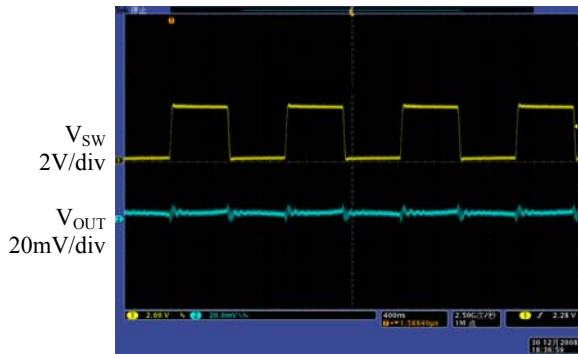

Figure 7. Output Voltage vs. Output Current

1.1MHz, 800mA SYNCHRONOUS DC-DC BUCK CONVERTER AP3406A

Typical Performance Characteristics (Continued)



400ns/div

Figure 8. Light Load Operation
($V_{IN}=3.6V$, $V_{OUT}=1.8V$, $I_{OUT}=0mA$)

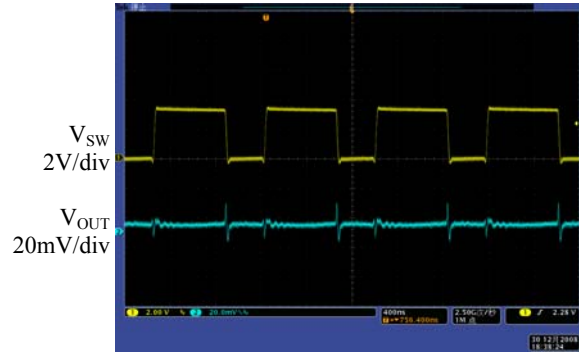

400ns/div

Figure 9. Heavy Load Operation
($V_{IN}=3.6V$, $V_{OUT}=1.8V$, $I_{OUT}=800mA$)

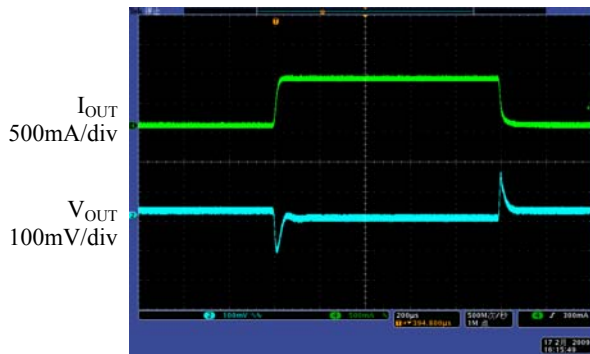

200µs/div

Figure 10. Load Transient
($V_{IN}=3.6V$, $V_{OUT}=1.8V$, $I_{OUT}=0mA$ to $800mA$)

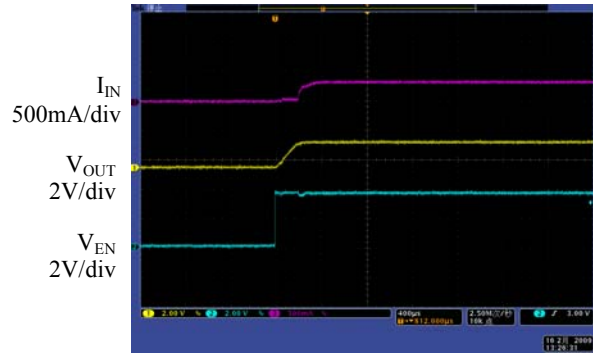

400µs/div

Figure 11. Start up from Shutdown
($V_{IN}=3.6V$, $V_{OUT}=1.8V$, $R_{LOAD}=2.5\Omega$)

1.1MHz, 800mA SYNCHRONOUS DC-DC BUCK CONVERTER AP3406A

Typical Performance Characteristics (Continued)

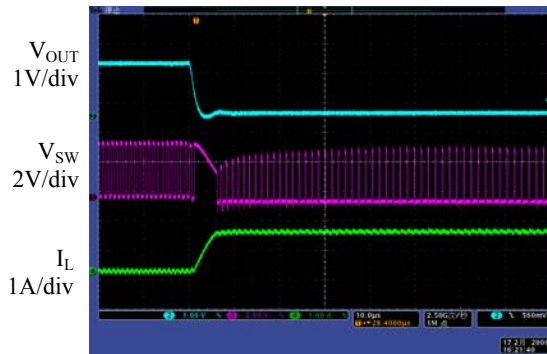

10µs/div

Figure 12. Short Circuit Protection
($V_{IN}=3.6V$, $V_{OUT}=1.8V$, no load)

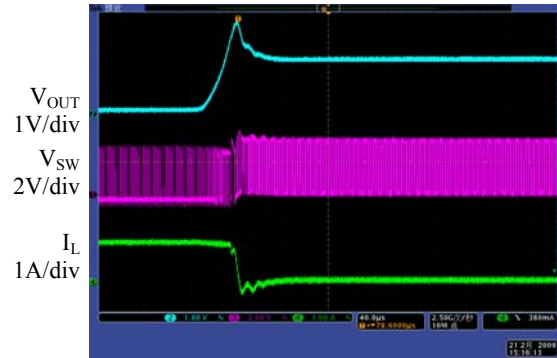

40µs/div

Figure 13. Short Circuit Recovery
($V_{IN}=3.6V$, $V_{OUT}=1.8V$, no load)

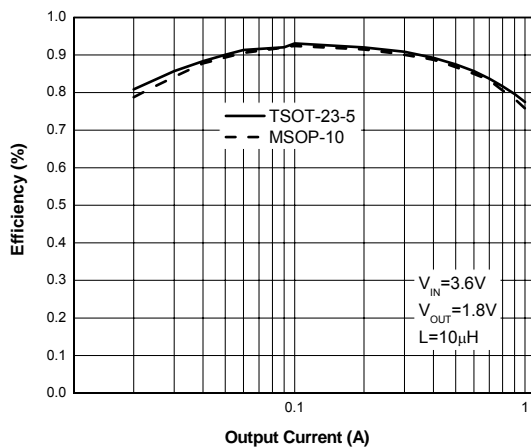

Figure 14. Efficiency vs. Output Current

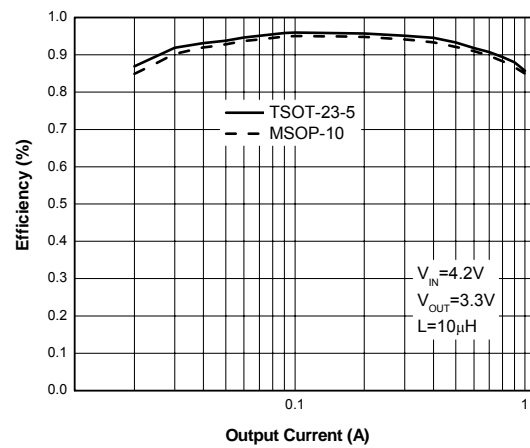

Figure 15. Efficiency vs. Output Current

1.1MHz, 800mA SYNCHRONOUS DC-DC BUCK CONVERTER AP3406A
Typical Performance Characteristics (Continued)

Figure 16. Normalized Feedback Voltage vs. Temperature

Typical Application

Figure 17. Typical Application of AP3406A

1.1MHz, 800mA SYNCHRONOUS DC-DC BUCK CONVERTER AP3406A

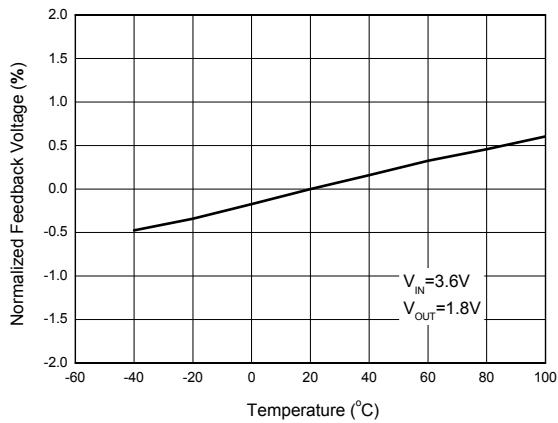
Mechanical Dimensions

TSOT-23-5

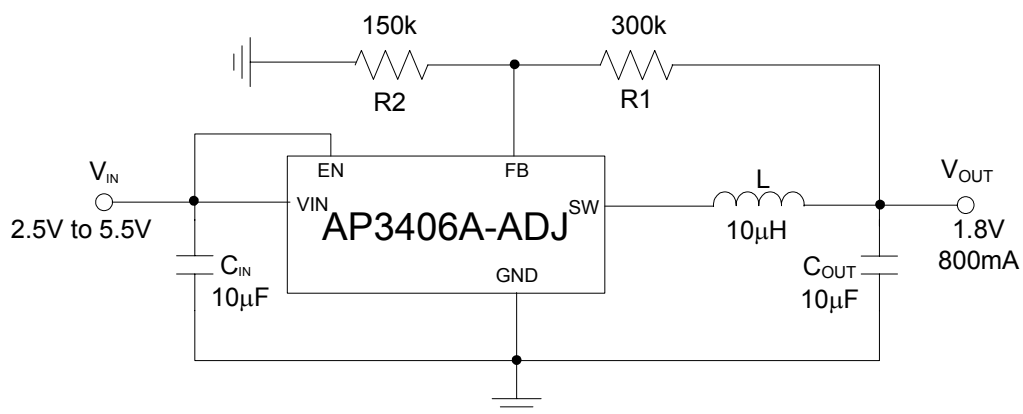
Unit: mm(inch)

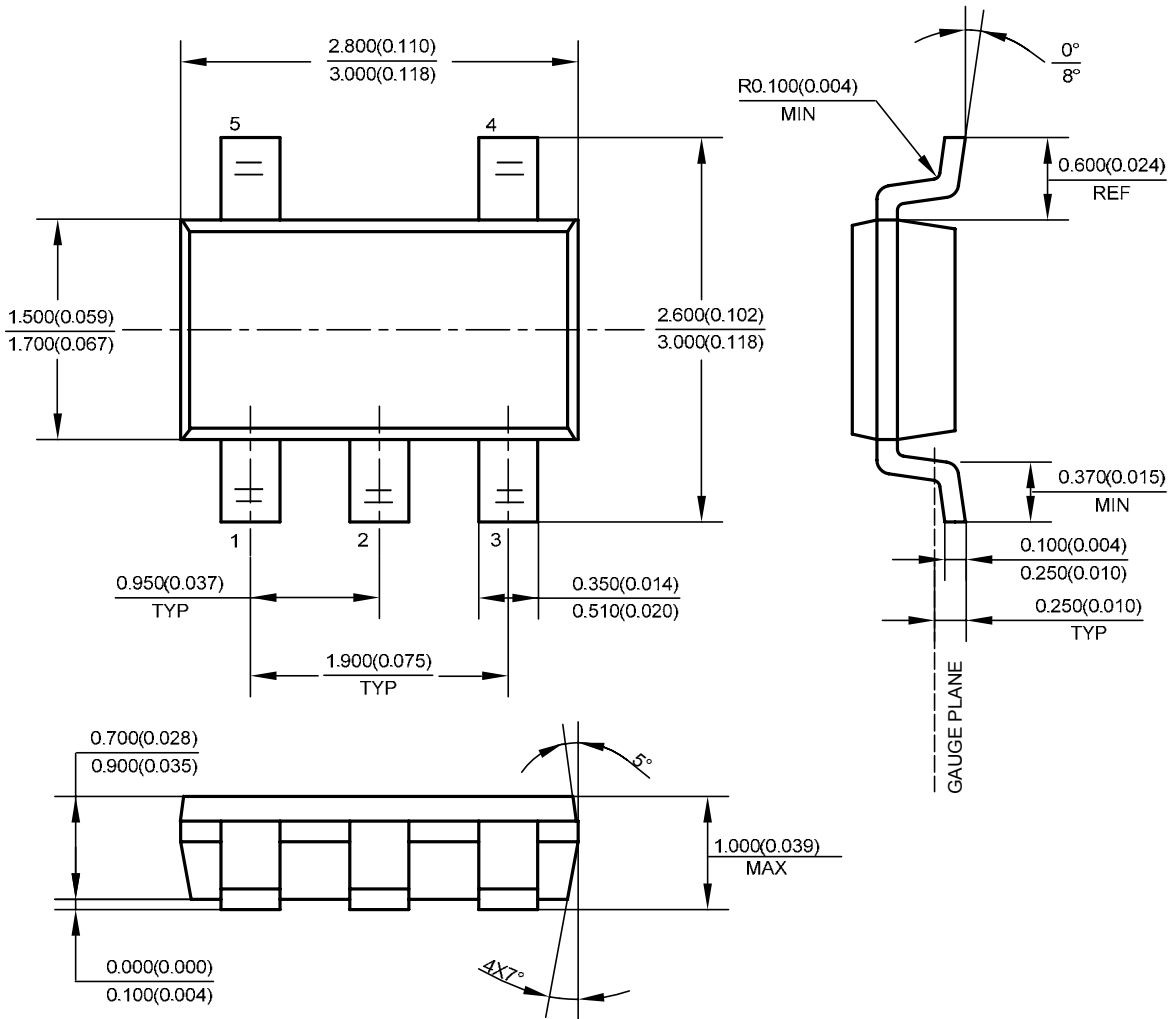

1.1MHz, 800mA SYNCHRONOUS DC-DC BUCK CONVERTER AP3406A

Mechanical Dimensions (Continued)

MSOP-10

Unit: mm(inch)

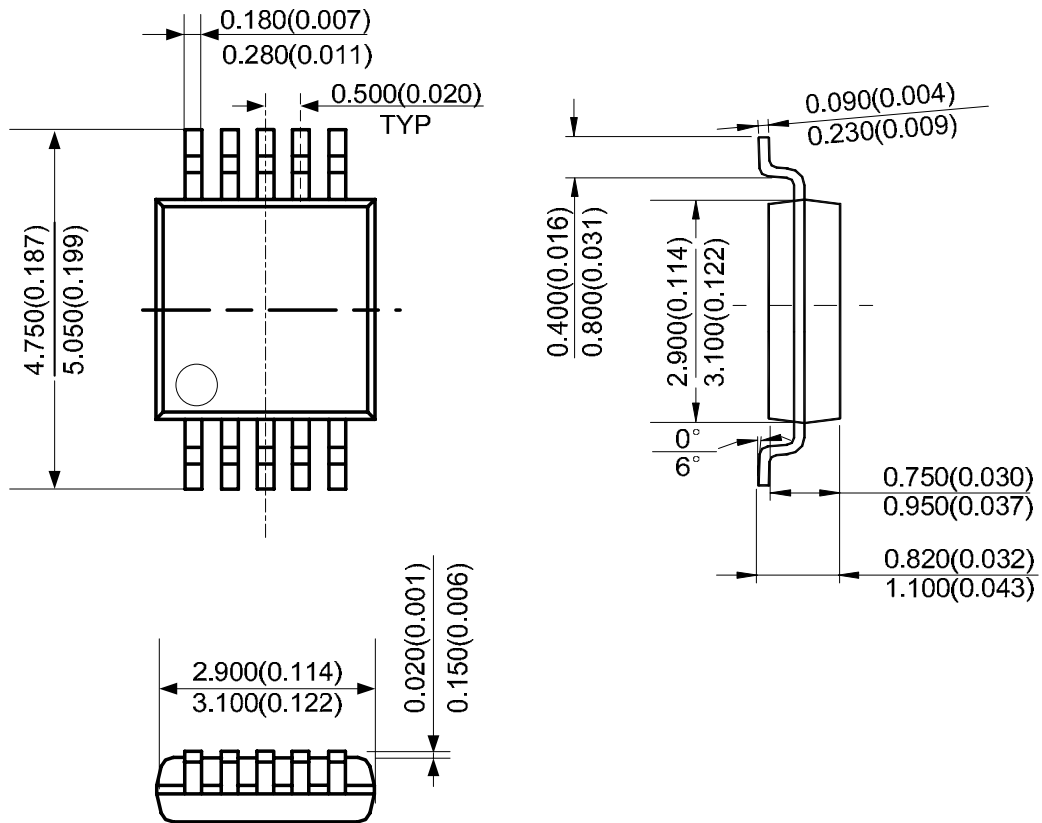

Note: Eject hole, oriented hole and mold mark is optional.

1.1MHz, 800mA SYNCHRONOUS DC-DC BUCK CONVERTER AP3406A

Mechanical Dimensions (Continued)

DFN-2x2-6(1)

Unit: mm(inch)

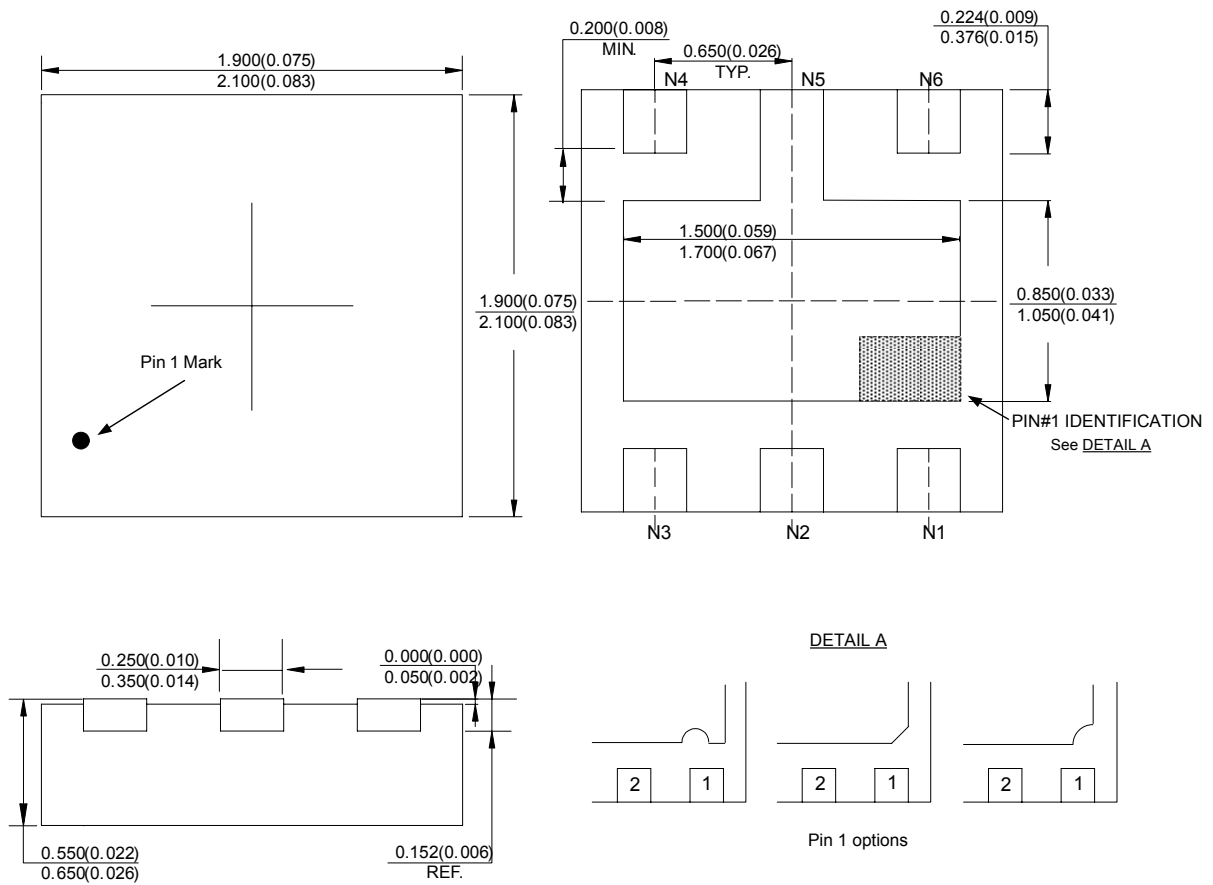



BCD Semiconductor Manufacturing Limited

<http://www.bcdsemi.com>

IMPORTANT NOTICE

BCD Semiconductor Manufacturing Limited reserves the right to make changes without further notice to any products or specifications herein. BCD Semiconductor Manufacturing Limited does not assume any responsibility for use of any its products for any particular purpose, nor does BCD Semiconductor Manufacturing Limited assume any liability arising out of the application or use of any its products or circuits. BCD Semiconductor Manufacturing Limited does not convey any license under its patent rights or other rights nor the rights of others.

MAIN SITE

- Headquarters

BCD Semiconductor Manufacturing Limited

No. 1600, Zi Xing Road, Shanghai ZiZhu Science-based Industrial Park, 200241, China
Tel: +86-21-24162266, Fax: +86-21-24162277

- Wafer Fab

Shanghai SIM-BCD Semiconductor Manufacturing Co., Ltd.

800 Yi Shan Road, Shanghai 200233, China
Tel: +86-21-6485 1491, Fax: +86-21-5450 0008

REGIONAL SALES OFFICE

Shenzhen Office

Shanghai SIM-BCD Semiconductor Manufacturing Co., Ltd., Shenzhen Office

Unit A Room 1203, Skyworth Bldg., Gaoxin Ave. 1.S., Nanshan District, Shenzhen, China
Tel: +86-755-8826 7951
Fax: +86-755-8826 7865

Taiwan Office

BCD Semiconductor (Taiwan) Company Limited

4F, 298-1, Rui Guang Road, Nei-Hu District, Taipei, Taiwan
Tel: +886-2-2656 2808
Fax: +886-2-2656 2806

USA Office

BCD Semiconductor Corp.

30920 Huntwood Ave. Hayward, CA 94544, USA
Tel : +1-510-324-2988
Fax: +1-510-324-2788

Mouser Electronics

Authorized Distributor

Click to View Pricing, Inventory, Delivery & Lifecycle Information:

[Diodes Incorporated:](#)

[AP3406AKT-ADJTRG1](#)