

## XTC (PHASE) PROGRAMMABLE

## CASE: XTC POLYCARBONATE

### GENERAL INFORMATION

LED Drive Type	Programmable Constant Current, Class 2
Input Voltage	120-277 (+/-10%)
Input Frequency	50/60Hz
Programming Method	I-LOC Keys
Dimming Control	Phase Dimming @ 120V
Dimming Range	Dims to Off
Power Factor @ Full Load	>0.95%
Efficiency @ Full Load	>80%
LED Power Up Time	<500ms
Load Regulation	<3%
Line Regulation (Max Load)	<3%
Output Over Voltage Protection	Yes, Auto Recovery
Output Overload Protection	Yes, Auto Recovery
Output Short-Circuit Protection	Yes
Over Temperature Protection	Yes
EMI Compliance	FCC Part 15 Class B

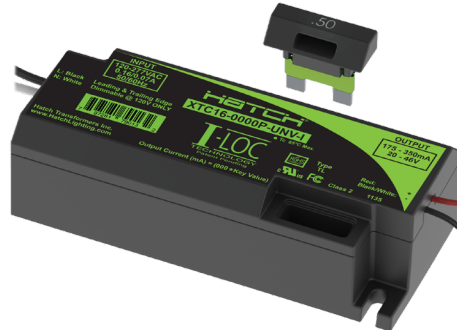

### ENVIRONMENTAL SPECIFICATIONS

Minimum Operating Temp.	-30°C
Maximum Case Temp. †	85°C
Maximum Storage Temp.	70°C
Maximum Relative Humidity	85% non-condensing
Transient Protection	NEMA SSL1-2010 Non-Roadway 2.5kV
UL Environment Rating	Dry & Damp
Sound Rating	Class A

†80°C Maximum Case Temperature for Warranty Purposes

### ELECTRICAL SPECIFICATIONS

Max. Power (W)	Output Voltage (VDC)	Output Current (mA)	Input Current (A) (120/277V)	Part Number
16W	20-46V	175-350mA	0.16/0.07	XTC16-0350P-UNV-I
32W	20-46V	350-700mA	0.32/0.14	XTC32-0700P-UNV-I
34W	14-32V	525-1050mA	0.35/0.15	XTC34-1050P-UNV-I

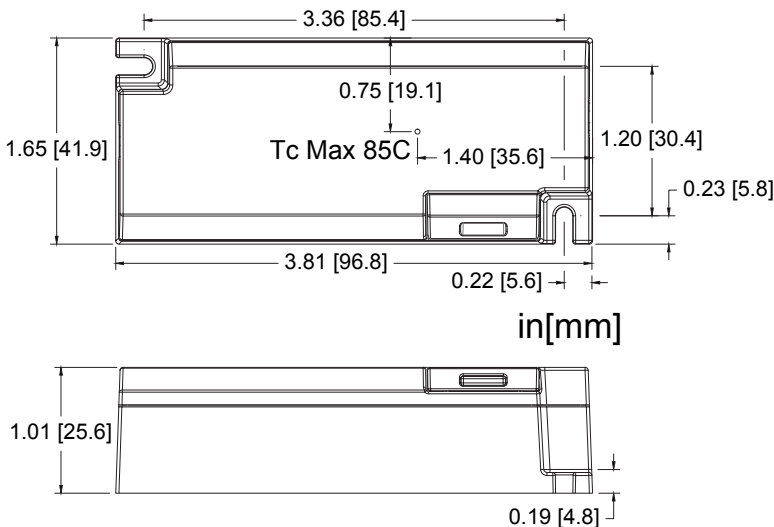

Always confirm fit with a physical sample.  
Specifications subject to change without notice.

### Wiring Information

Input:	6" # 18AWG Black (L), White (N)
Output:	6" # 22AWG Red (+), Black/White (-)

### Packaging Information

Weight:	0.57 lbs
Quantity:	50 pc/carton



For an I-LOC Demo visit:  
<http://www.hatchlighting.com/about-i-loc/>

Hatch I-LOC Technology enables quick and easy setting of driver output current with the simple click of a key. Select the appropriate I-LOC key for the desired output current and click it into the driver.

The keys are **Interchangeable** across the Hatch I-LOC LED Driver product family and have a 50% to maximum output range. The 0.28 to 0.48 keys are designed exclusively for the Linear I-LOC family.

MODEL		XTC-16-0350P-UNV-I			XTC-32-0700P-UNV-I			XTC-34-1050P-UNV-I		
Drive Factor	Part Number	Max Output (mA)	Voltage Range (V)	Max Output (W)	Max Output (mA)	Voltage Range (V)	Max Output (W)	Max Output (mA)	Voltage Range (V)	Max Output (W)
1.00	XA100	350	20-46	16	700	20-46	32	1050	14-32	34
0.98	XB098	343	20-46	16	686	20-46	32	1029	14-32	33
0.95	XC095	333	20-46	16	665	20-46	31	998	14-32	32
0.93	XD093	326	20-46	15	651	20-46	30	977	14-32	32
0.90	XE090	315	20-46	15	630	20-46	29	945	14-32	31
0.88	XF088	308	20-46	15	616	20-46	29	924	14-32	30
0.85	XG085	298	20-46	14	595	20-46	28	893	14-32	29
0.83	XH083	291	20-46	14	581	20-46	27	872	14-32	28
0.80	XI080	280	20-46	13	560	20-46	26	840	14-32	27
0.78	XJ078	273	20-46	13	546	20-46	26	819	14-32	26
0.75	XK075	263	20-46	13	525	20-46	25	788	14-32	26
0.73	XL073	256	20-46	12	511	20-46	24	767	14-32	25
0.70	XM070	245	20-46	12	490	20-46	23	735	14-32	24
0.68	XN068	238	20-46	11	476	20-46	22	714	14-32	23
0.65	XO065	228	20-46	11	455	20-46	21	683	14-32	22
0.63	XP063	221	20-46	11	441	20-46	21	662	14-32	22
0.60	XQ060	210	20-46	10	420	20-46	20	630	14-32	21
0.58	XR058	203	20-46	10	406	20-46	19	609	14-32	20
0.55	XS055	193	20-46	9	385	20-46	18	578	14-32	19
0.53	XT053	186	20-46	9	371	20-46	17	557	14-32	18
0.50	XU050	175	20-46	8	350	20-46	16	525	14-32	17

Adjusted Output Current Tolerance +/- 3%

## Operating Range

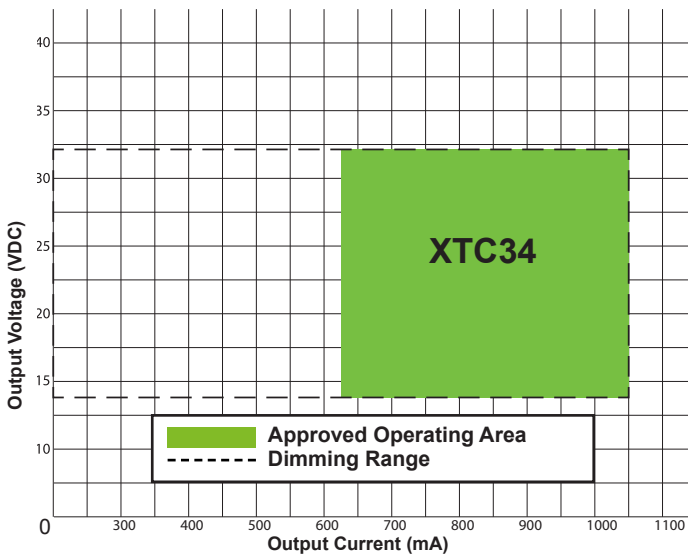
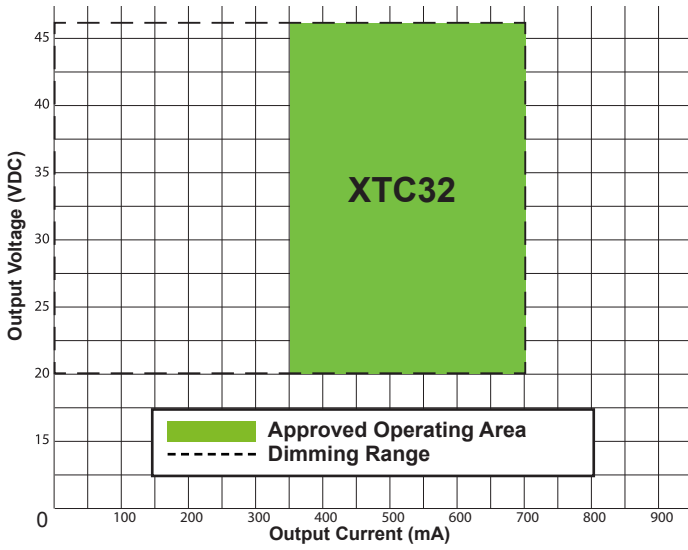
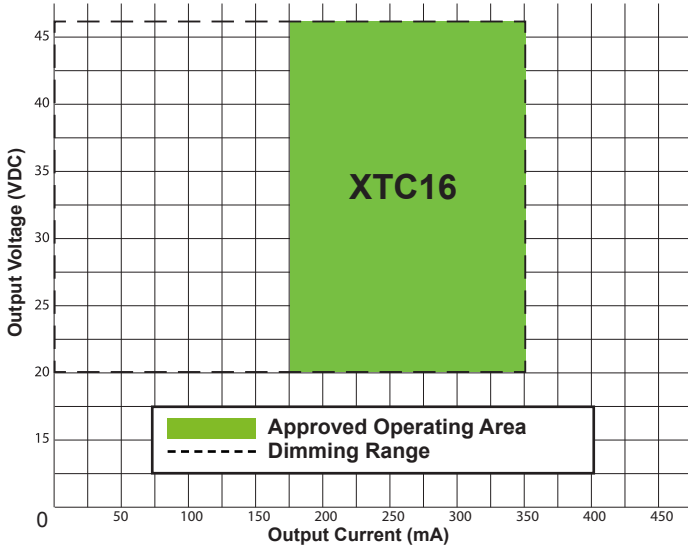

## Dimming Range

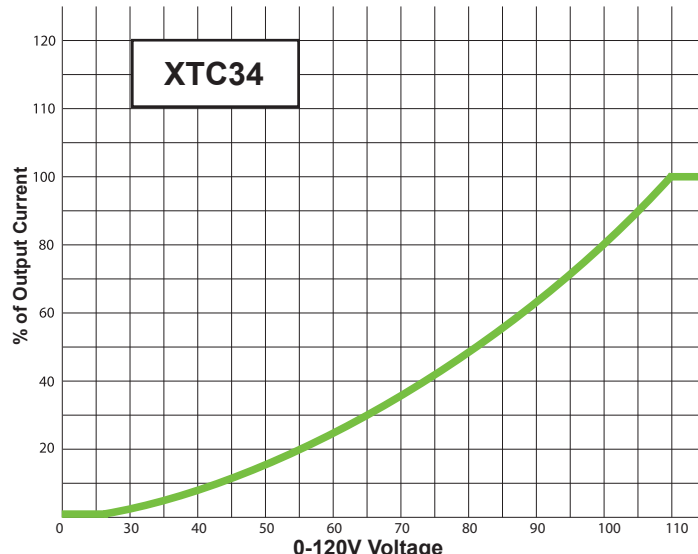
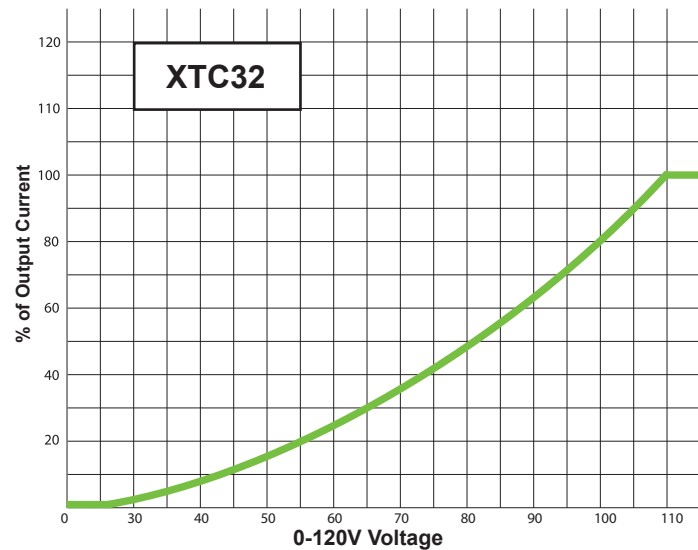
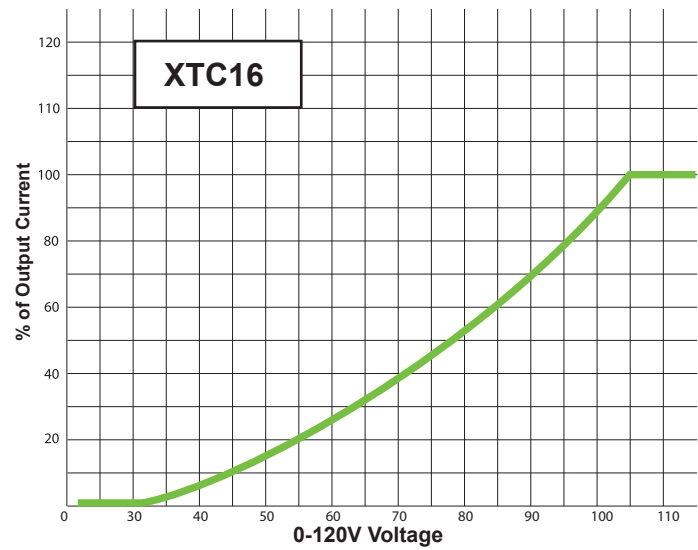

## Lifetime vs Case Temperature (Full Load)

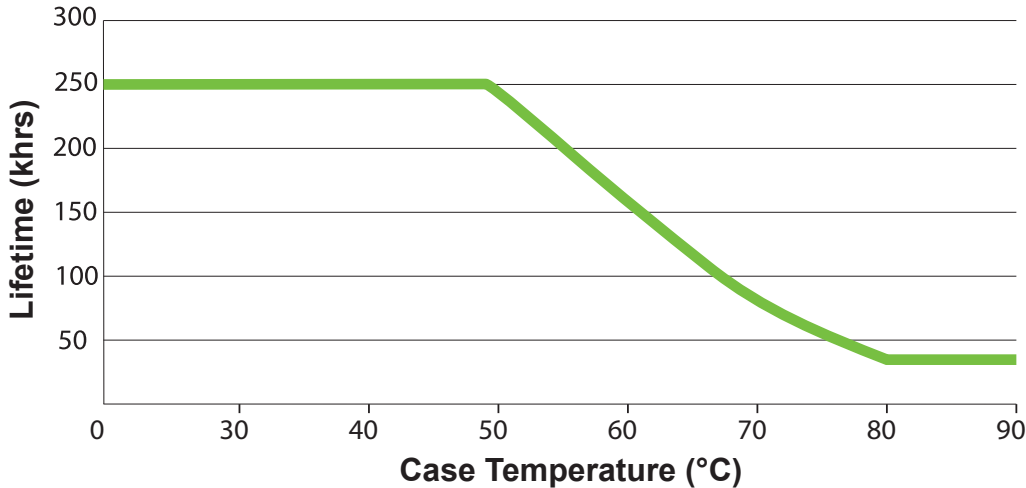

## TL Information

Product	Key Range	Tref Max	Tref @ 40 °C
XTC16	0.50-0.65	90°C	66°C
	0.68-0.80	90°C	69°C
	0.83-1.00	89°C	77°C
XTC32	0.50-0.65	82°C	52°C
	0.68-0.80	90°C	58°C
	0.83-1.00	78°C	63°C
XTC34	0.50-0.65	90°C	66°C
	0.68-0.80	86°C	67°C
	0.83-1.00	89°C	76°C

## Inrush Characteristics

Product	Input Voltage Vin (vrms)	Ipk (A)	T 50%pk (µS)
XTC16	120	0.58	59
	277	1.18	52
XTC32	120	0.88	50
	277	1.36	94
XTC34	120	0.74	63
	277	1.28	95

For an I-LOC Demo visit: <http://www.hatchlighting.com/about-i-loc/>

# Mouser Electronics

Authorized Distributor

Click to View Pricing, Inventory, Delivery & Lifecycle Information:

## [Hatch Lighting:](#)

[XTC16-0350P-UNV-I](#) [XTC32-0700P-UNV-I](#) [XTC34-1050P-UNV-I](#)