

Incandescent Indicators



T-1 3/4
MIDGET
FLANGE BASE

See lamp ratings
on page J.

TWO TERMINALS—FULLY INSULATED
FOR MOUNTING IN 15/32" CLEARANCE HOLE

MEET OR EXCEED ENVIRONMENTAL AND OPERATIONAL REQUIREMENTS
OF MIL-L-6723 AND MIL-L-3661B

Feature

- Anti-rotation (locked) construction: Provides for secure locking of the socket terminal assembly in the mounting bushing and of the center terminal to the insulating disc. The notched mounting bushing receives the matched insulating disc to prevent the rotation of the mounting bushing.

MATERIALS AND FINISHES

- **Mounting Bushing:** Aluminum, black anodize finish. Optional—clear anodize finish.
- **Internal-tooth Lockwasher and Mounting Nut:** Steel, cadmium plated with yellow iridescent chromate finish.
- **Terminals:** Brass, hot tinned with elongated slot.

How to designate the Three Digit Part Number Suffix (—XXX)

Finish	Resistor	Hardware
5 — black anodize	0 — none	2 — steel
6 — clear anodize		

Example: 162-8430-0971-602 (clear anodize finish, no resistor, steel hardware).

162 SERIES
178 SERIES

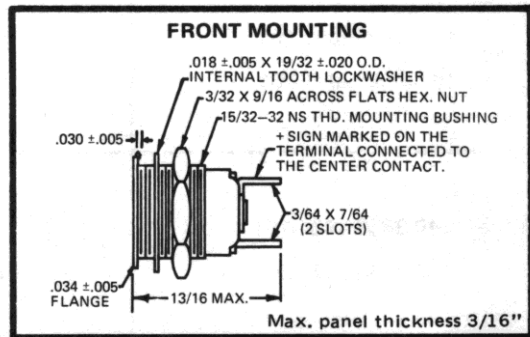

BASE PART NUMBERS

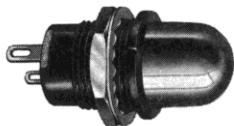

162-8430-0971-502

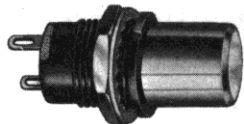

162-8430-1471-502



178-8430-0371-502



178-8430-0111-502

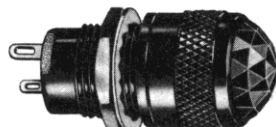

178-8430-2131-502

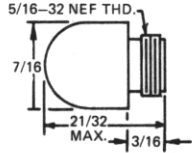
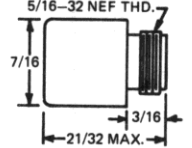
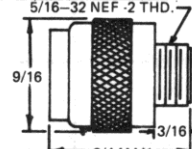
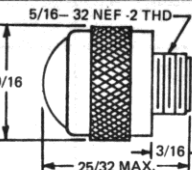
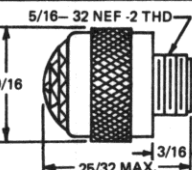
CAP PART NUMBERS	COMPLETE ASSEMBLY PART NUMBERS
 <p>STOVEPIPE 162-0971 translucent</p>	162-8430-0971-502
 <p>CYLINDRICAL 162-1431 transparent 162-1471 translucent</p>	162-8430-1431-502 162-8430-1471-502
For legends on flat faced lens, see page P.	
 <p>FLAT 178-0331-500 transparent 178-0371-500* translucent</p>	178-8430-0331-502 178-8430-0371-502
For legends on flat faced lens, see page P.	
 <p>CONVEX 178-0131-500 unfrosted 178-0111-500 back frosted</p>	178-8430-0131-502 178-8430-0111-502
 <p>FACETED 178-2131-500 unfrosted</p>	178-8430-2131-502

*Specify translucent colors as follows: Red -0371; Green -0372; Yellow (amber) -0373; Blue -0374; White -0375; Light yellow -0376.

Part numbers shown in gray are normally in inventory at your Dialight Distributor.

Mouser Electronics

Authorized Distributor

Click to View Pricing, Inventory, Delivery & Lifecycle Information:

Dialight:

[162-8430-0934-502](#) [162-8430-09-602](#) [162-8430-0937-502](#) [162-8430-09-500](#) [162-8430-09-600](#) [162-8430-0932-502](#)
[178-2131-500](#) [162-8430-0931-502](#) [162-8430-0975-502](#) [162-8430-09-502](#) [162-0936](#) [178-2132-500](#) [162-8430-0933-502](#)