

# RP1A, RP1B

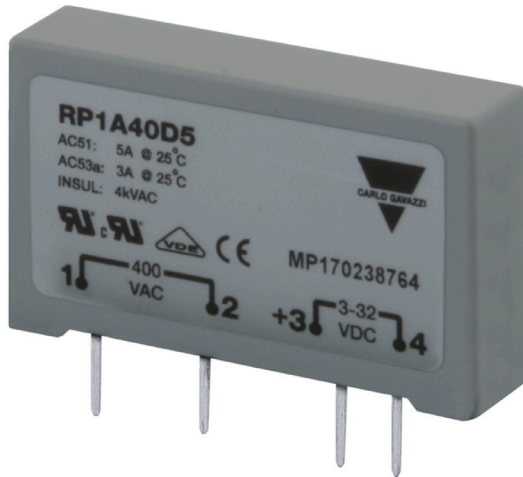

## 1-phase PCB mount solid state relays



### Main features

- AC Solid State Relay for PCB mounting
- Zero switching or instant-on
- Rated operational current: 3, 5 or 5.5 AACrms
- Rated operational voltage: Up to 480 VACrms
- Surface mount technology
- Flexible encapsulation for extended life
- Control voltage: 3 to 32 VDC / 16 to 32 VAC
- Opto-isolation: > 4000 VACrms
- Blocking voltage: Up to 1000 Vp
- Non-repetitive surge current: Up to 250 Ap

### Description

The **RP1** is an SSR series for socket- or PCB-mounting, providing an ideal interface between logic controls and AC loads.

The **RP1** is designed for resistive and inductive loads up to 480 VACrms.

Internally this new series enjoys an improved technical design with the introduction of stress-free flexible encapsulation and automated assembly of components.

The Solid State technology used can withstand peak voltages of 1000 V, making the **RP1** series suitable to drive AC loads such as valve solenoids and small induction motors.

### Applications

These relays can be used to switch heaters, motors, lights, valves or solenoids.

### Main functions

- Zero cross or Instant on AC switching
- Ratings up to 480 VACrms, 5.5 AACrms
- 3-32 VDC or 16-32 VAC control voltage

## References

 **Order code**

 **RP1**

Enter the code entering the corresponding option instead of

Code	Option	Description	Notes
R	-	Solid State Relay (PCB)	
P	-		
1	-		Number of poles
<input type="checkbox"/>	A	Switching mode: zero switching	
	B	Switching mode: instant-On switching	
<input type="checkbox"/>	23	Rated operational voltage: 230 VACrms	
	40	Rated operational voltage: 400 VACrms	
	48	Rated operational voltage: 480 VACrms	
<input type="checkbox"/>	D	Control voltage: 3 to 32 VDC	4 to 32 VDC for RP1A48.. 4 to 32 VDC for RP1B40.. and RP1B48..
	A	Control voltage: 16 to 32 VAC	Only available for 230V, 5.5 A
<input type="checkbox"/>	3	Rated operational current: 3 AACrms	
	5	Rated operational current: 5 AACrms	
	6	Rated operational current: 5.5 AACrms	
<input type="checkbox"/>	Mx	M1 = Mounting on DIN EN adaptor <b>RPM1</b>	Max. 250V
		M2 = Mounting on DIN EN adaptor <b>RPM2</b>	Max. 600V

### Selection guide

Rated operational voltage	Blocking voltage	Control voltage	Rated operational current		
			3 AACrms	5 AACrms	5.5 AACrms
230 VACrms	650 Vp	3 to 32 VDC	RP1A23D3 RP1B23D3	RP1A23D5 RP1B23D5	RP1A23D6 RP1B23D6
		16 to 32 VAC	-	-	RP1A23A6
400 VACrms	850 Vp	3 to 32 VDC	RP1A40D3 RP1B40D3	RP1A40D5 RP1B40D5	RP1A40D6 RP1B40D6
		4 to 32 VDC			
480 VACrms	1000 Vp	4 to 32 VDC	RP1A48D3 RP1B48D3	RP1A48D5 RP1B48D5	RP1A48D6 RP1B48D6

### Selection Guide (mounted on DIN EN adaptor)

Rated operational voltage	Blocking voltage	Control voltage	Rated operational current		
			3 AACrms	5 AACrms	5.5 AACrms
230 VACrms	650 Vp	5 to 34 VDC	RP1A23D3M1 RP1B23D3M1	RP1A23D5M1 RP1B23D5M1	RP1A23D6M1 RP1B23D6M1
		16 to 32 VAC	-	-	RP1A23A6M1*
480 VACrms	1000 Vp	6 to 34 VDC	-	RP1A48D5M2	-

\* Version RP1A23A6M1 does not include an LED on the DIN adaptor.



**CARLO GAVAZZI compatible components**

Purpose	Component name/code	Notes
DIN adaptors	RPM1* RPM1V* RPM1P RPM1PD* RPM2	DIN adaptor 250V with LED DIN adaptor 250V with LED + varistor DIN adaptor 250V with pins for removal of RP DIN adaptor 250V with pins for removal of RP + LED DIN adaptor 600V with LED

\*not suitable for use with RP1A23A6

**Further reading**

Information	Where to find it
-	-



# Features

## General

<b>Material</b>	PBT, RAL7035
<b>Potting compound</b>	Flame-retardant flexible silicone rubber
<b>Weight</b>	Approx. 20 g
<b>Isolation: input to output</b>	4 kVACrms
<b>Insulation resistance</b>	$10^{10}$
<b>Insulation capacitance</b>	8 pF

## Dimensions

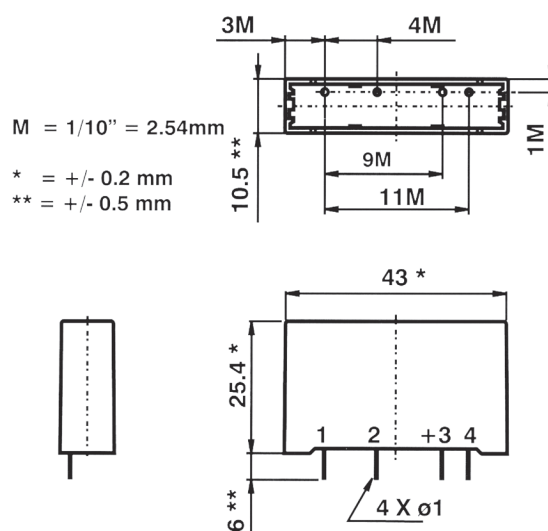

## Performance

### Mains supply

	RP1.23	RP1.40	RP1.48
<b>Operational voltage range</b> RP1A RP1B	12 - 265 VACrms 12 - 265 VACrms	20 - 440 VACrms 12 - 440 VACrms	20 - 530 VACrms 12 - 530 VACrms
<b>Operational frequency range</b>	45 - 65 Hz		
<b>Blocking voltage</b>	650 Vp	850 Vp	1000 Vp
<b>Zero voltage turn-on</b>	< 10 V		

### Outputs

	RP1...3	RP1...5	RP1...6
<b>Rated operational current</b> AC 51 @ $T_a = 25^\circ\text{C}$ AC 53a @ $T_a = 25^\circ\text{C}$	3 A 2 A	5 A 3 A	5.5 A 5 A
<b>Min. operational load current</b>	20 mA		
<b>Power factor</b>	> 0.5		
<b>Rep. overload current t=1 s</b>	10 AACrms	12 AACrms	16 AACrms
<b>Non-rep. surge current t=20 ms</b>	65 Ap	80 Ap	250 Ap
<b>Off-state leakage current</b>	< 1 mA		
<b>I<sup>2</sup>t for fusing t=10 ms</b>	20 A <sup>2</sup> s	50 A <sup>2</sup> s	340 A <sup>2</sup> s
<b>Critical dV/dt off state min.</b>	250 V/ $\mu$ s	500 V/ $\mu$ s	
<b>On-state voltage drop @ rated current</b>	< 1.2 Vrms		

### Inputs

	RP1..D	RP1..D..Mx	RP1A23A6
<b>Control voltage</b> RP1.23.. RP1A40.. RP1B40.. RP1.48..	3-32 VDC 4-32 VDC	5-34 VDC 6-34 VDC	16 - 32 VAC - -
<b>Pick-up voltage</b> RP1.23.. RP1A40.. RP1B40.. RP1.48..	2.8 VDC 3.8 VDC	4.8 VDC 5.8 VDC	10 VAC - -
<b>Drop-out voltage</b>	1.2 VDC		5 VAC
<b>Max. input current</b> RP1A... RP1B...	10 mADC 15 mADC		13 mAAC - -
<b>Max. reverse voltage</b>	32 VDC	34 VDC	-
<b>Response time pick-up</b> RP1A... RP1B...	< 10 ms < 160 $\mu$ s (12 VDC/ 50 Hz) < 320 $\mu$ s (5 VDC/ 50 Hz)		< 20 ms - -
<b>Response time drop-out</b> RP1A... RP1B...	< 10 ms < 10 ms		< 20 ms - -

**Derating curve**

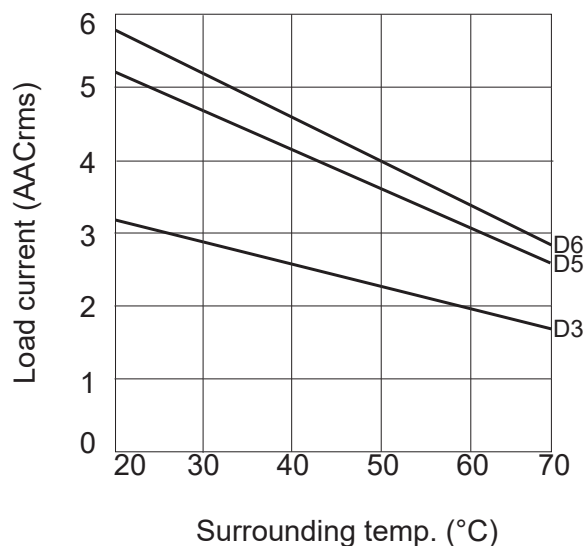

Derating curve is used for finding max. load current at an elevated ambient temperature. The 3 lines in the graph represent the 3 nominal current ratings of the RP1 series (RP1...D3/D5/D6). When used at full load current, the relays must be placed vertically. If more than one relay is mounted, please allow a minimum distance of 20 mm in between for sufficient air cooling.

**Increased Current Options**

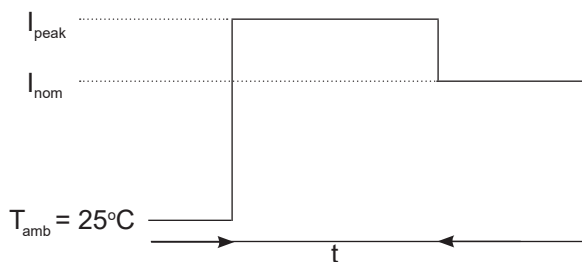







<b>I peak (Amps)</b>	6	8	10
<b>D5 : t (minutes)</b>	15	5	3
<b>D6 : t (minutes)</b>	15	5	3

Note: even though the D3 can withstand a slight increase in current for a limited time, it is not recommended for this purpose.



**Compatibility and conformity**

<b>Standards compliance</b>	LVD: EN 60947-4-3 EMCD: EN 61000-6-2, EN 61000-6-4 UL508 C22.2 No. 14-13 VDE 0700, VDE 0805 (excluding RP1A23A6)
<b>Approvals</b>	     

<b>Electromagnetic compatibility (EMC) - immunity</b>	
<b>Electrostatic discharge (ESD)</b>	EN/IEC 61000-4-2 8 kV air discharge, 4 kV contact (PC1)
<b>Radiated radio frequency</b>	EN/IEC 61000-4-3 10 V/m, from 80 MHz to 1 GHz (PC1) 10 V/m, from 1.4 to 2 GHz (PC1) 10 V/m, from 2 to 2.7 GHz (PC1)
<b>Electrical fast transient (burst)</b>	EN/IEC 61000-4-4 Output: 2 kV, 5 kHz (PC2) Input: 1 kV, 5 kHz (PC2)
<b>Conducted radio frequency</b>	EN/IEC 61000-4-6 10V/m, from 0.15 to 80 MHz (PC1)
<b>Electrical surge</b>	EN/IEC 61000-4-5 Output, line to line: 1 kV (PC2) Output, line to earth: 1 kV (PC2) <sup>1</sup> Input, line to line: 500 V (PC2) <sup>2</sup> Input, line to earth: 500 V (PC2) <sup>2</sup>
<b>Voltage dips</b>	EN/IEC 61000-4-11 0% for 0.5, 1 cycle (PC2) 40% for 10 cycles (PC2) 70% for 25 cycles (PC2)
<b>Voltage Interruptions</b>	EN/IEC 61000-4-11 0% for 5000ms (PC2)

<b>Electromagnetic compatibility (EMC) - emissions</b>	
<b>Radio interference field emission (radiated)</b>	EN/IEC 55011 Class A: from 30 to 1000 MHz
<b>Radio interference voltage emissions (conducted)</b>	From 0.15 to 30 MHz EN/IEC 55011 Class A (industrial) with filter capacitor across the Mains supply EN/IEC 60947-4-3 Class A (no filtering needed)

Note:

- Performance Criteria 1 (PC1): no degradation of performance or loss of function is allowed when the product is operated as intended.
- Performance Criteria 2 (PC2): during the test, degradation of performance or partial loss of function is allowed. However when the test is complete the product should return operating as intended by itself.
- Performance Criteria 3 (PC3): temporary loss of function is allowed, provided the function can be restored by manual operation of the controls.
- Control input lines must be installed together to maintain products' susceptibility to Radio Frequency interference.
- <sup>1</sup> A suppression device, such as a varistor, needs to be connected across the output terminals L1, T1 for immunity against higher voltage levels.
- <sup>2</sup> A suppression device, such as a transil, needs to be connected across the control terminals A1, A2 for immunity against higher voltage levels.



**Environmental specifications**

<b>Operating temperature</b>	-20° to +70°C (-4° to +158°F)
<b>Storage temperature</b>	-40° to +100°C (-40° to +212°F)
<b>Pollution degree</b>	2
<b>EU RoHS compliant</b>	Yes
<b>China RoHS</b>	

The declaration in this section is prepared in compliance with People’s Republic of China Electronic Industry Standard SJ/T11364-2014: Marking for the Restricted Use of Hazardous Substances in Electronic and Electrical Products.

Part Name	Toxic or Harardous Substances and Elements					
	Lead (Pb)	Mercury (Hg)	Cadmium (Cd)	Hexavalent Chromium (Cr(VI))	Polybrominat-ed biphenyls (PBB)	Polybromi-nated diphenyl ethers (PBDE)
<b>Power Unit Assembly</b>	x	o	o	o	o	o

O: Indicates that said hazardous substance contained in homogeneous materials fot this part are below the limit requirement of GB/T 26572.

X: Indicates that said hazardous substance contained in one of the homogeneous materials used for this part is above the limit requirement of GB/T 26572.

这份申明根据中华人民共和国电子工业标准 SJ/T11364-2014：标注在电子电气产品中限定使用的有害物质

零件名称	有毒或有害物质与元素					
	铅 (Pb)	汞 (Hg)	镉 (Cd)	六价铬 (Cr(VI))	多溴化联苯 (PBB)	多溴联苯醚 (PBDE)
功率单元	x	o	o	o	o	o

O:此零件所有材料中含有的该有害物低于GB/T 26572的限定。

X: 此零件某种材料中含有的该有害物高于GB/T 26572的限定。



**RP1... Functional diagram**

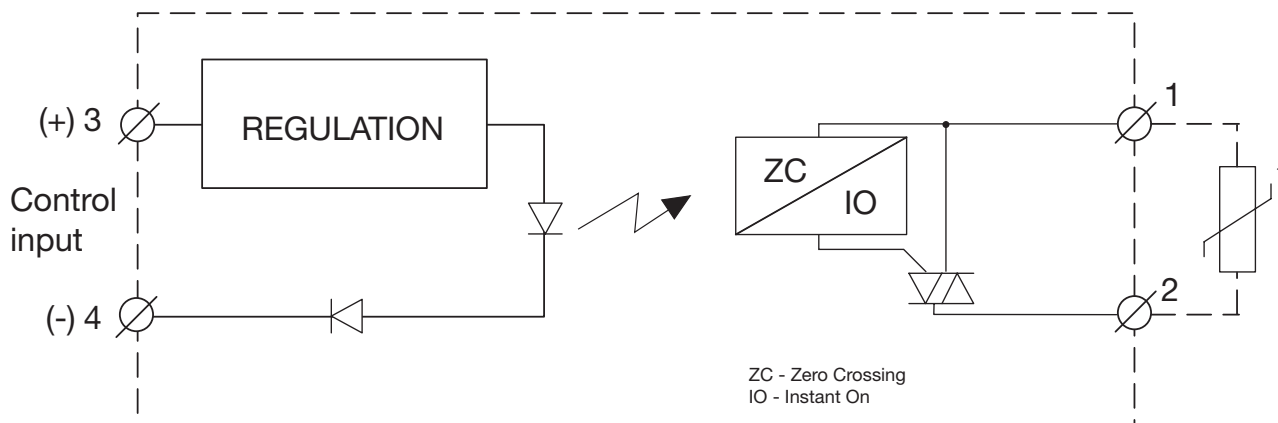

**RP..Mx Functional diagram**

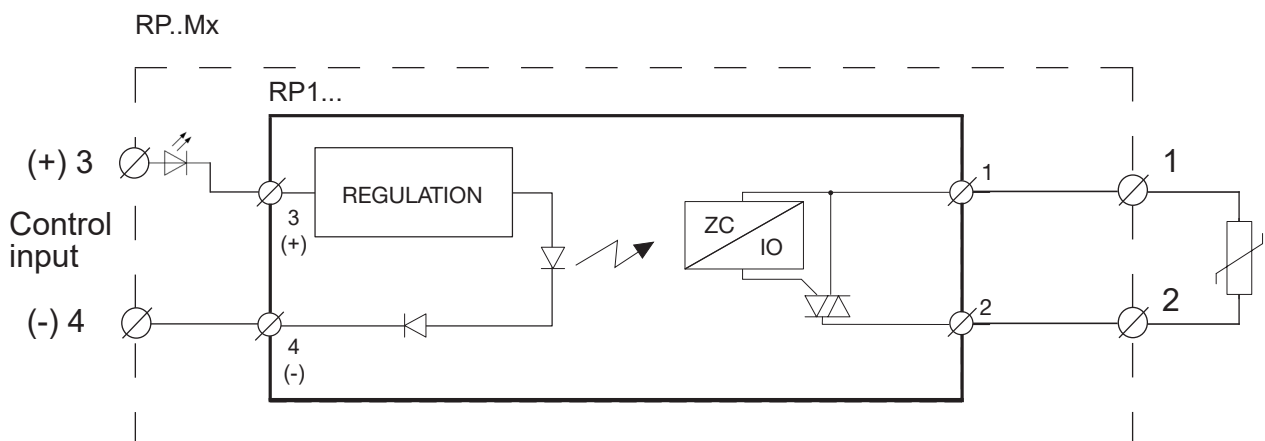

\* The varistor is not included in the solid state relay. Connecting a varistor across terminals 1-2 helps protect the solid state relay against damages by over-voltage

**Connection specifications**

Terminals	Copper alloy, tin-plated
Terminals soldering temperature	max. 300°C for 5 seconds

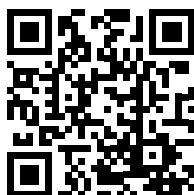

COPYRIGHT ©2019  
Content subject to change. Download the PDF: [www.productselection.net](http://www.productselection.net)

# Mouser Electronics

Authorized Distributor

Click to View Pricing, Inventory, Delivery & Lifecycle Information:

[Carlo Gavazzi:](#)

[RP1A48D5M2](#) [RP1B40D3](#) [RP1A40D3](#) [RP1B23D3M1](#) [RP1B48D6](#) [RP1A23D6](#) [RP1B23D6](#) [RP1B40D5](#) [RP1B40D6](#)  
[RP1B48D10](#) [RP1B48D3](#) [RP1B23D6M1](#)