



TFT LCD Module

Product Specification

DT070DTFT-IPS-HB
7.0" (1024RGB x 600 DOTS) IPS TFT Module

November 1, 2019

Remark:

Contents in this document are subject to change without notice. No part of this document may be reproduced or transmitted in any form or by any means, electronic or mechanical, for any purpose, without the express written permission of Displaytech.

Displaytech

Email: sales@displaytech.com.hk

Website: <http://www.displaytech.com.hk>

Revision Record

REV	CHANGES	DATE
A (Ref. 1.3 20191017)	First release	Nov 1, 2019

Table of Content

Revision Record	1
1. Scope	4
2. Application	4
3. General Information.....	4
4. Outline Drawing	5
5. Interface signals	6
6. Absolute maximum Ratings	7
6.1. Electrical Absolute max. ratings	7
6.2. Environment Conditions	7
7. Electrical Specifications	8
7.1 Electrical characteristics.....	8
7.2 LED Backlight.....	8
8. Command/AC Timing	9
8.1 TTL mode AC electrical Characteristics	9
8.2 LVDS mode AC electrical characteristics.....	9
8.3 Data input format	11
8.4 LVDS mode data input format	11
8.5 Timing diagram	12
8.6 Power ON/OFF Sequence.....	12
9. Optical Specification	14
10. Environmental / Reliability Tests	17
11. Precautions for Use of LCD Modules	18
11.1 Safety.....	18
11.2 Handling	18
11.3 Static Electricity	18
11.4 Storage.....	18

11.5 Cleaning 18

11.6 Cautions for installing and assembling 18

1. Scope

This data sheet is to introduce the specification of DT070DTFT-IPS-HB, active matrix IPS TFT module. It is composed of a color TFT-LCD panel, driver ICs, FPC and a backlight unit. The 7.0" display area contains 1024(RGB) x 600 pixels.

As to basic specification of the driver IC, refer to the IC specification and datasheet.

2. Application

Digital equipments which need color display, mobile navigator/video systems.

3. General Information

Item	Contents	Unit
Size	7.0	inch
Resolution	1024(RGB)*600	/
Interface	LVDS	/
Technology type	IPS	/
Pixel Configuration	R.G.B Stripe	
Outline Dimension (W x H x D)	164.80 x 99.80 x 5.65	mm
Active Area	154.21 x 85.92	mm
Backlight Type	LED	/
Display Controller /driver	HX8282A11/HX8696A 01	/
Viewing Direction	ALL	
Weight	TBD	g

4. Outline Drawing

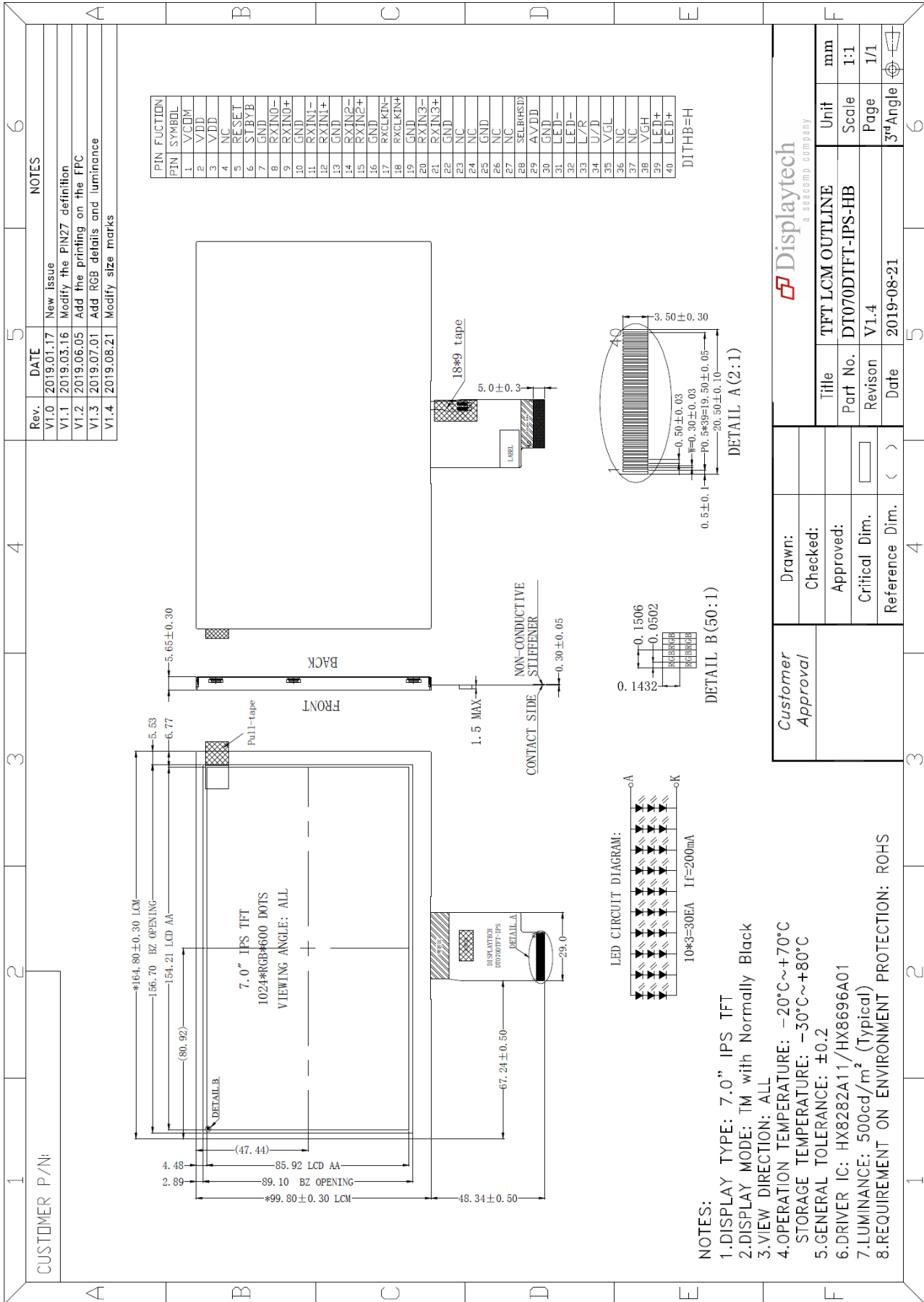

5. Interface signals

Pin No.	Symbol	Description	Remark
1	VCOM	Common voltage	
2	VDD	Power supply	
3	VDD	Power supply	
4	NC	No connection	
5	RESET	Global reset pin, Active low	
6	STBYB	Standby mode, Active low	
7	GND	Power Ground	
8	RXIN0-	Differential Data Input ,CH0 (Negative)	
9	RXIN0+	Differential Data Input ,CH0 (Positive)	
10	GND	Power Ground	
11	RXIN1-	Differential Data Input ,CH1 (Negative)	
12	RXIN1+	Differential Data Input ,CH1 (Positive)	
13	GND	Power Ground	
14	RXIN2-	Differential Data Input ,CH2 (Negative)	
15	RXIN2+	Differential Data Input ,CH2 (Positive)	
16	GND	Power Ground	
17	RXCLKIN-	Differential Clock Input (Negative)	
18	RXCLKIN+	Differential Clock Input (Positive)	
19	GND	Power Ground	
20	RXIN3-	Differential Data Input ,CH3 (Negative)	
21	RXIN3+	Differential Data Input ,CH3 (Positive)	
22	GND	Power Ground	
23	NC	No connection	
24	NC	No connection	
25	GND	Power Ground	
26	NC	No connection	
27	NC	No connection	
28	SELB(HSD)	LVDS Mode Input Select. HSD="L": 8-bit HSD="H": 6-bit	
29	AVDD	Power supply for analog circuits	
30	GND	Power Ground	
31	LED-	Power for LED backlight (Cathode)	
32	LED+	Power for LED backlight (Cathode)	
33	L/R	Source Right or Left sequence control.	Note
34	U/D	Gate Up or Down scan control.	Note
35	VGL	Gate OFF Voltage	
36	NC	No connection	
37	NC	No connection	
38	VGH	Gate ON Voltage	
39	LED+	Power for LED backlight (Anode)	
40	LED+	Power for LED backlight (Anode)	

Note:

U/D	L/R	FUNCTION
0	1	Normal Display
0	0	Inverse Left and Right
1	1	Inverse Up and Down
1	0	Inverse Left and Right Inverse Up and Down

6. Absolute maximum Ratings

6.1. Electrical Absolute max. ratings

Parameter	Symbol	MIN	MAX	Unit	Remark
Power Supply Voltage	VDD	-0.3	5.0	V	
	AVDD	-0.5	15.0	V	
	VGH	-0.3	40.0	V	
	VGL	-20	0.3	V	
Logic Signal Input /output Voltage	V _{Iovcc}	-0.3	VDD+0.5	V	
Current of LED	I _{LED}	0	200	mA	

Note1: If the module is above these absolute maximum ratings. It may become permanently damaged. Using the module within the following electrical characteristic conditions are also exceeded, the module will malfunction and cause poor reliability.

Note2: Please be sure users are grounded when handing LCD Module.

6.2. Environment Conditions

Item	Symbol	MIN	MAX	Unit	Remark
Operating Temperature	TOPR	-20	70	°C	
Storage Temperature	TSTG	-30	80	°C	

Note1: The response time will become lower when operated at low temperature.

Note2: Background color changes slightly depending on ambient temperature. The phenomenon is reversible.

Note3: Ta≤40°C:85%RH MAX.

Ta>40°C:Absolute humidity must be lower than the humidity of 85%RH at 40°C.

7. Electrical Specifications

7.1 Electrical characteristics

GND=0V, Ta=25°C

Item	Symbol	MIN	TYP	MAX	Unit	Remark
Power Supply	VDD	2.6	3.3	3.6	V	
	VCOM	2.85	3.0	3.45	V	
	AVDD	9.4	9.6	9.8	V	
	VGH	17	18	19	V	
	VGL	-6.6	-6.0	-5.4	V	
Input Voltage	H	V_{IH}	0.8VDD	-	VDD	VDD=2.8V
	L	V_{IL}	0	-	0.2VDD	
Current Consumption	I_{VDD}	-	30	45	mA	
	I_{AVDD}	-	35	45	mA	

7.2 LED Backlight

Ta=25°C

Item	Symbol	MIN	TYP	MAX	Unit	Remark
Forward Current	IL	-	200	-	mA	
Forward Voltage	VL	-	9.6	-	V	Note1
LED life time	-	-	25000	-	Hr	Note2

Note1: The LED Supply Voltage is defined by the number of LED at Ta=25°C and IL =200mA.

Note2: The “LED life time” is defined as the module brightness decrease to 50% original brightness at Ta=25°C and IL =200mA. The LED lifetime could be decreased if operating IL is larger than200mA.

Note3: LED Power Consumption: 1920mW Typ.

LED CIRCUIT DIAGRAM:

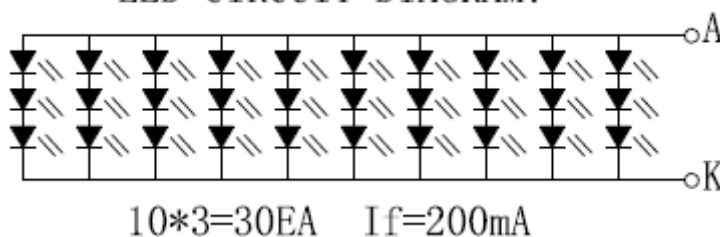

8. Command/AC Timing

8.1 TTL mode AC electrical Characteristics

Parameter	Symbol	Spec			Unit	Condition
		Min.	Typ.	Max.		
VDD Power On Slew rate	TPOR	-	-	20	ms	From 0V to 90% VDD
RSTB pulse width	TRst	50	-	-	us	DCLK=65MHz
DCLK cycle time	Tcph	14	-	-	ns	-
DCLK pulse duty	Tcwh	40	50	60	%	-
VSD setup time	Tvst	5	-	-	ns	-
VSD hold time	Tvhd	5	-	-	ns	-
HSD setup time	Thst	5	-	-	ns	-
HSD hold time	Thhd	5	-	-	ns	-
Data set-up time	Tdsu	5	-	-	ns	D0[7:0], D1[7:0], D2[7:0] to DCLK
Data hold time	Tdhd	5	-	-	ns	D0[7:0], D1[7:0], D2[7:0] to DCLK
DE setup time	Tesu	5	-	-	ns	
DE hold time	Tehd	5	-	-	ns	
Output stable time	Tsst	-	-	6	us	10% to 90% target voltage. CL=90Pf, R=10K ohm (Cascade) Dual gate
		-	-	3		

Table: TTL mode AC electrical characteristics

8.2 LVDS mode AC electrical characteristics

Parameter	Symbol	Spec			Unit	Condition
		Min.	Typ.	Max.		
Clock Frequency	RXFCLK	20	-	71	MHz	
Input data skew margin	TRSKM	500	-	-	ps	VID =400Mv RXVCM=1.2V RXFCLK=71MHz
Clock high time	TLVCH	-	4/(7*RXFCLK)	-	ns	
Clock low time	TLVCL	-	3/(7*RXFCLK)	-	ns	
PLL wake-up time	TemPLL	-	-	150	us	

Table: LVDS mode AC electrical characteristics

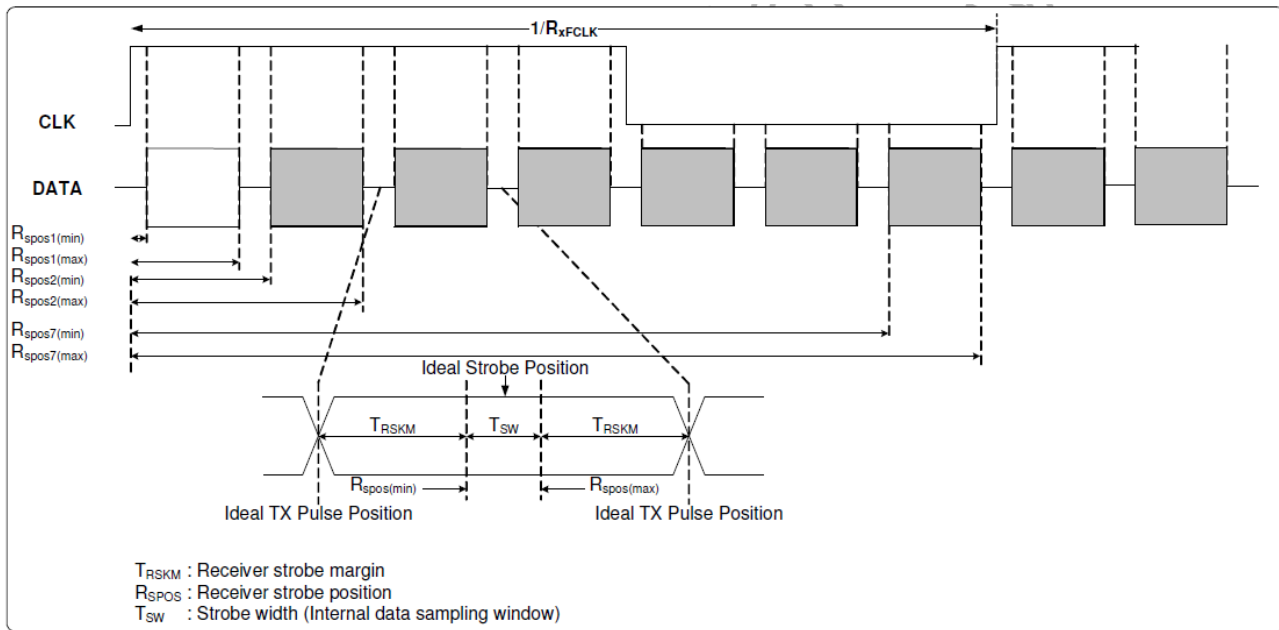
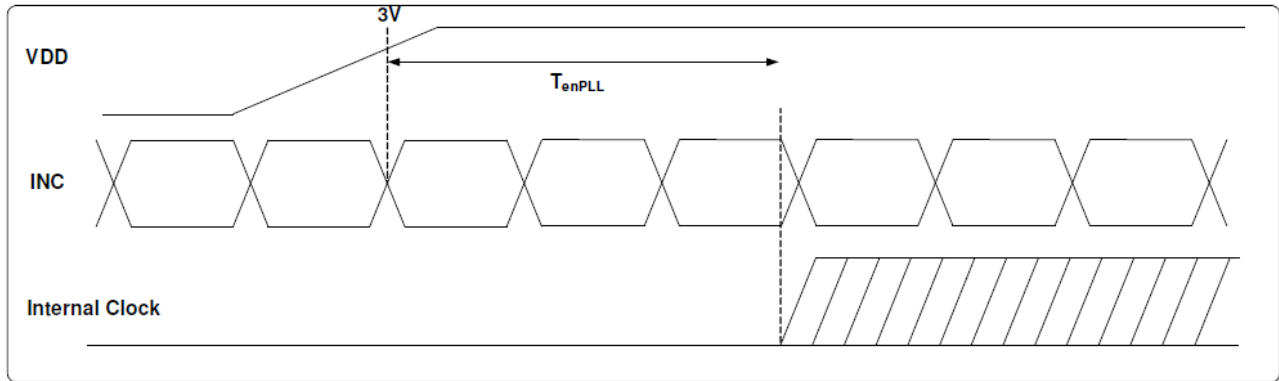
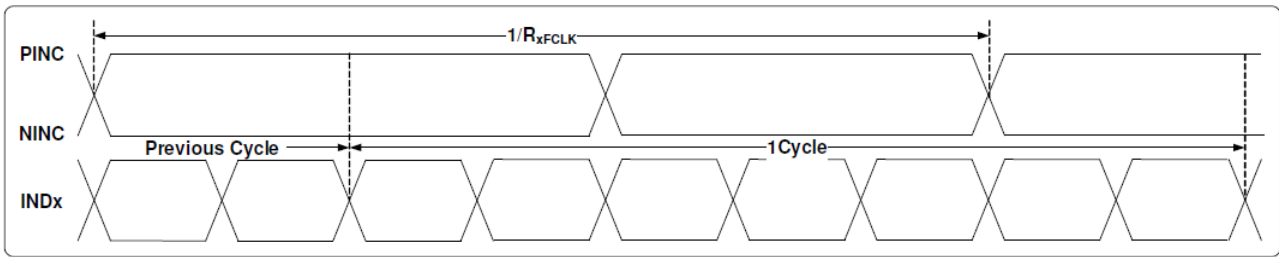

Figure: LVDS figure

Parameter	Symbol	Spec			Unit	Condition
		Min.	Typ.	Max.		
Modulation Frequency	SSCMF	23	-	93	KHz	
Modulation Rate	SSCMR	-	-	+/-3	%	LVDS clock=71MHz center spread

8.3 Data input format

8.3.1.TTL mode data input format

Vertical timing

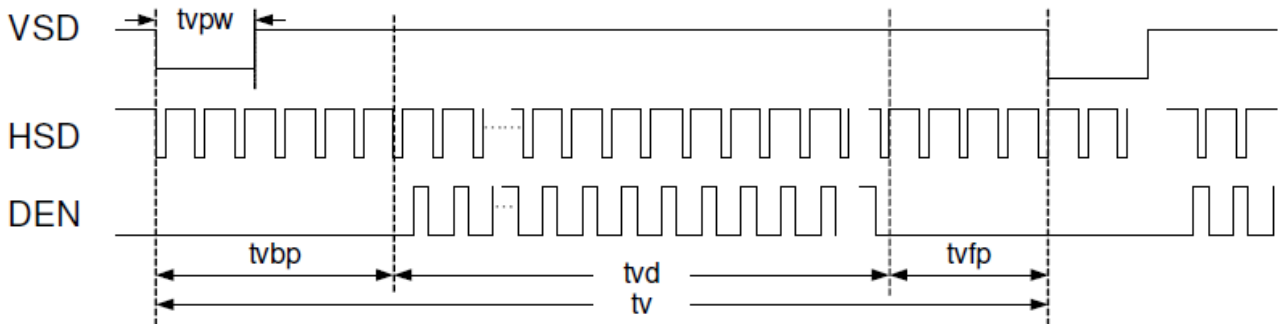

Figure: Vertical input timing diagram

Horizontal timing

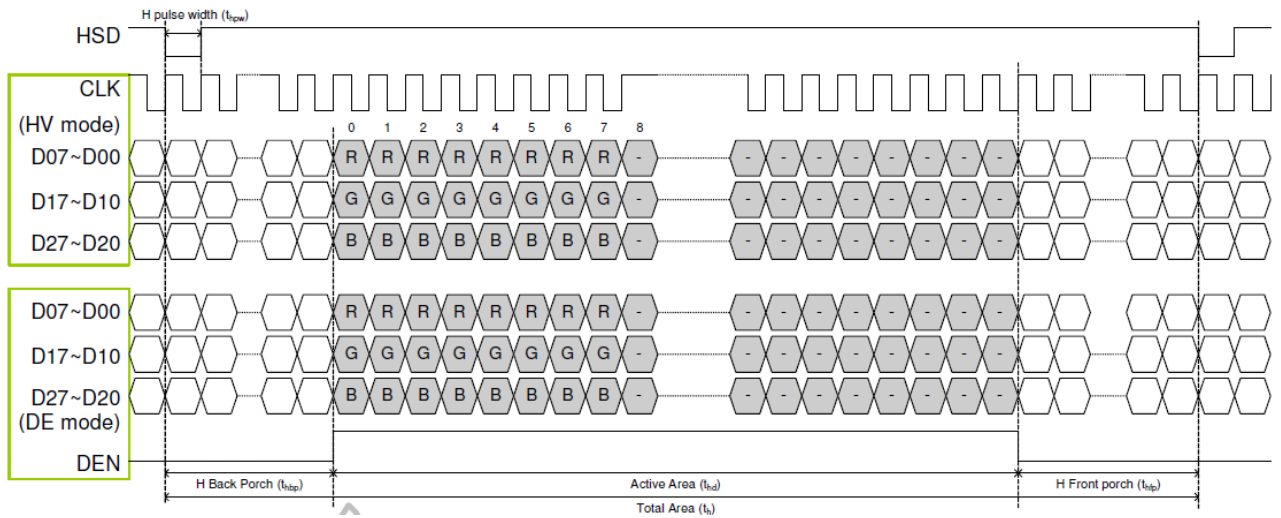

Figure: Horizontal input timing diagram

8.4 LVDS mode data input format

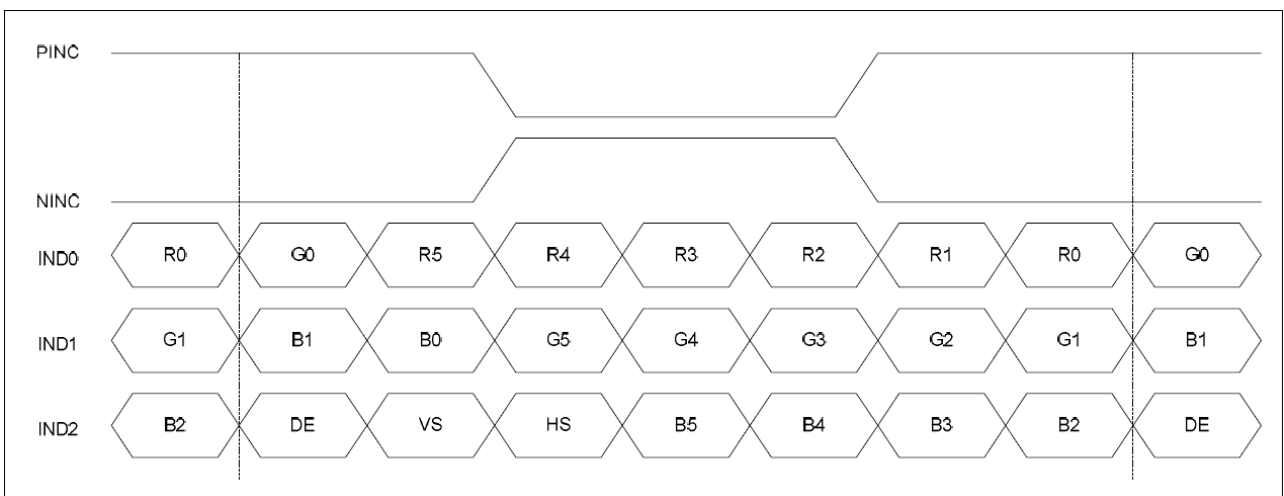

Figure: 6-bit LVDS input

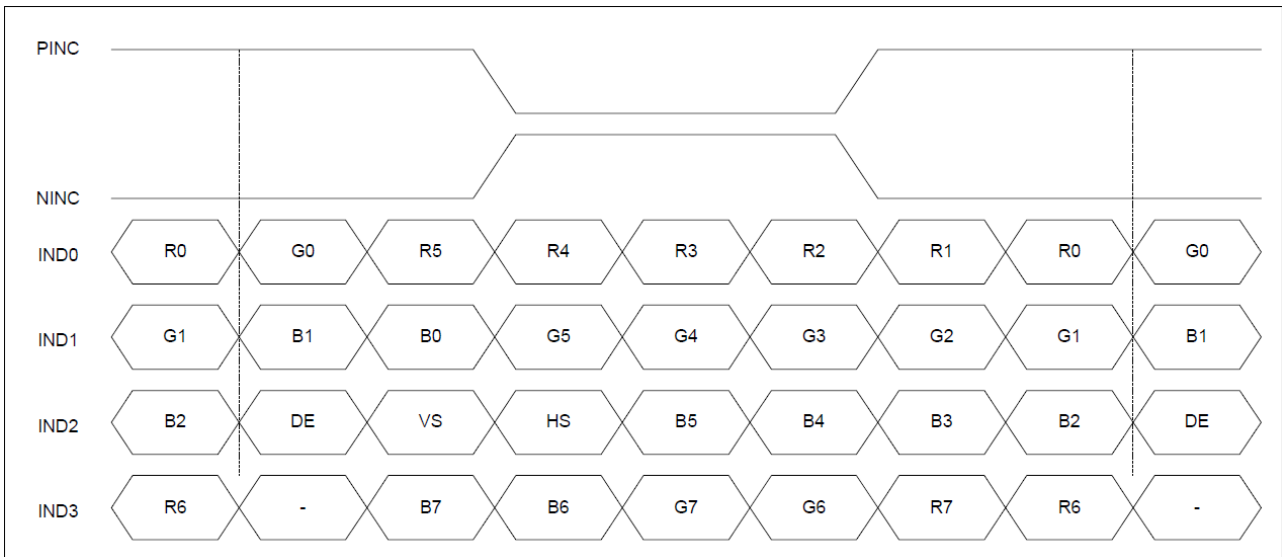

Figure: 8-bit LVDS Input

8.5 Timing diagram

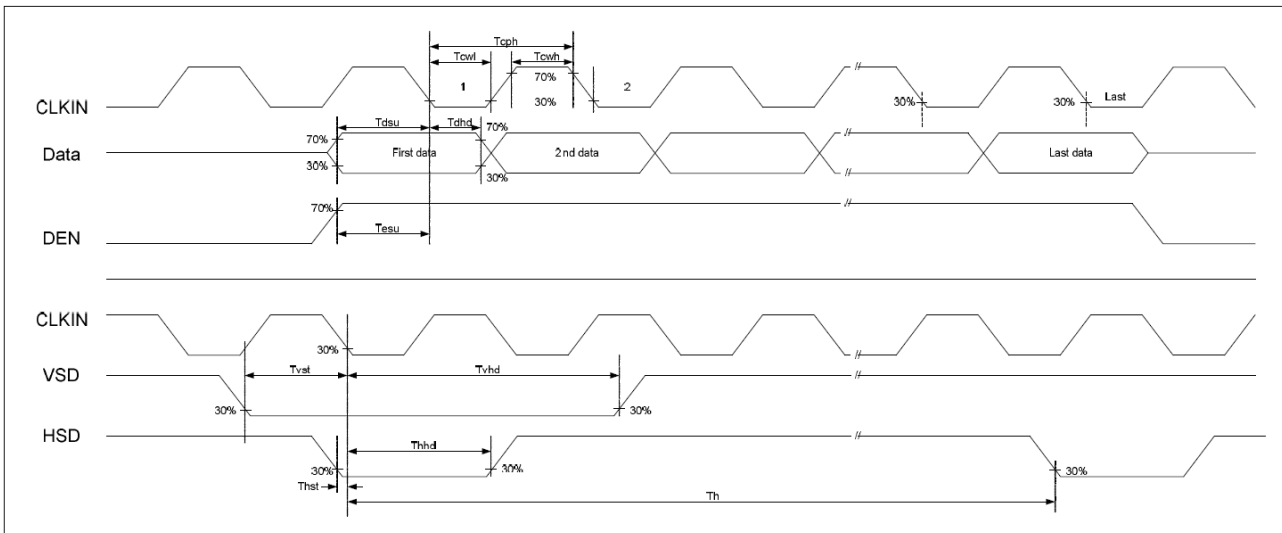

Figure: Input clock and data timing diagram

8.6 Power ON/OFF Sequence

To prevent the device damage from latch up, the power on/off sequence shown below must be followed.

Power on: VDD, GND → AVDD, AGND → V1 to V14

Power off: V1 to V14 → AVDD, AGND → VDD, GND

8.6.1. Power ON/OFF Control

HX8282A has a power on/off sequence control function. In order to prevent IC from power on reset fail, the rising time (TPOR) of the digital power supply VDD should be maintained within the given specifications. Please refer to “AC Characteristics” for more detail on timing.

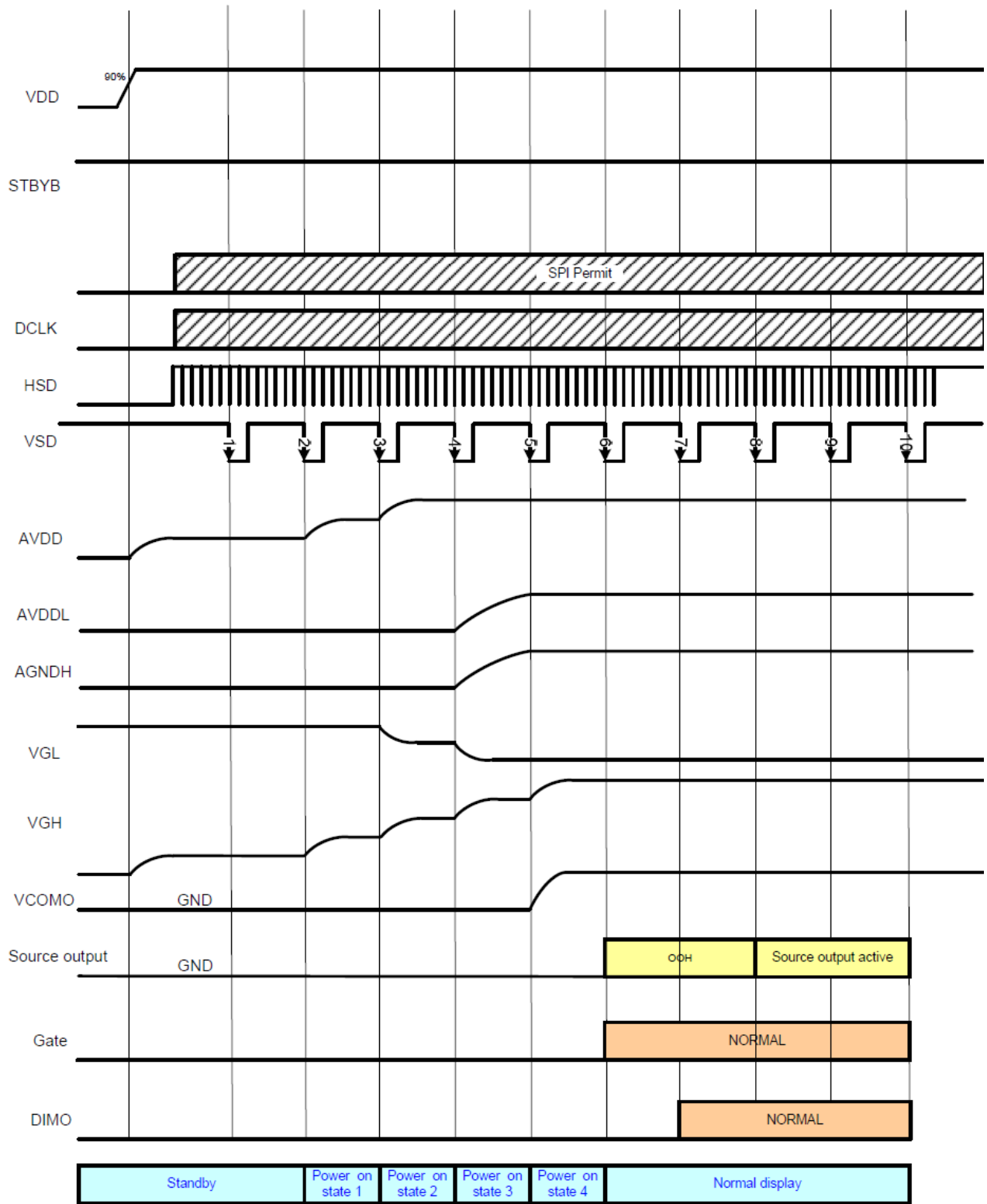

Note: Low level = 3FH, when NBW=L (Normally white)
 Low level =00H, when NBW=H (Normally black)

Figure: Power on/off timing sequence

9. Optical Specification

Ta=25°C

Item	Symbol	Condition	Min	Typ.	Max.	Unit	Remark
Contrast Ratio	CR	$\Theta=0^{\circ}$	500	800	-		Note1 Note2
Response Time	Tr+Tf	25°C	-	25	40	ms	Note1 Note3
View Angles	ΘT	CR ≥ 10	80	85	-	Degree	Note4
	ΘB		80	85	-		
	ΘL		80	85	-		
	ΘR		80	85	-		
Chromaticity	White	X	Brightness is on	Typ-0.03	0.303	Typ+0.03	Note5 Note1
		Y			0.333		
	Red	X			0.618		
		Y			0.326		
	Green	X			0.285		
		Y			0.539		
	Blue	X			0.146		
		Y			0.148		
Luminance	L		-	500	-	cd/m2	Note1 Note6
Uniformity	U		75	80	-	%	Note1 Note7

Note 1: Definition of optical measurement system.
 Temperature = 25°C(±3°C)
 LED back-light: ON, Environment brightness < 150 lx

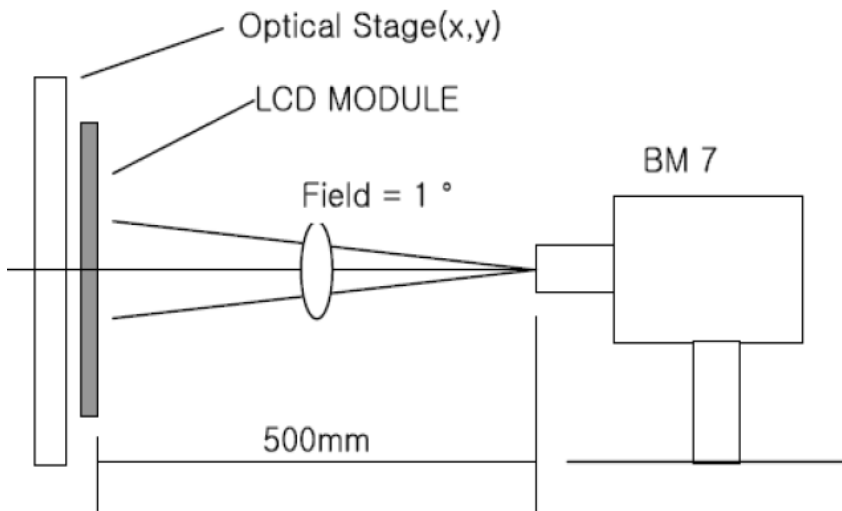

Note 2: Contrast ratio is defined as follow:

$$\text{Contrast Ratio} = \frac{\text{Surface Luminance with all white pixels}}{\text{Surface Luminance with all black pixels}}$$

Note 3: Response time is defined as follow:

Response time is the time required for the display to transition from black to white (Rise Time, Tr) and from white to black(Decay Time, Tf).

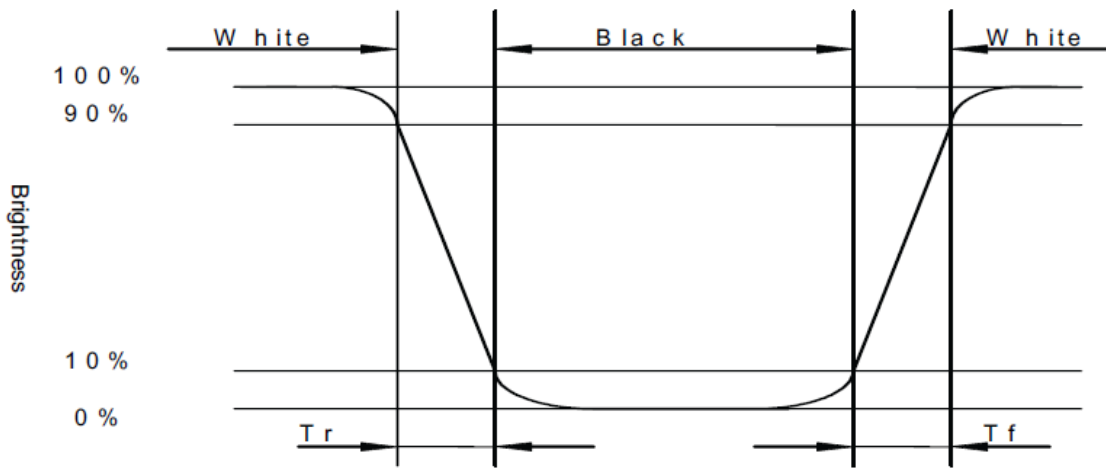

Note 4: Viewing angle range is defined as follow:

Viewing angle is measured at the center point of the LCD.

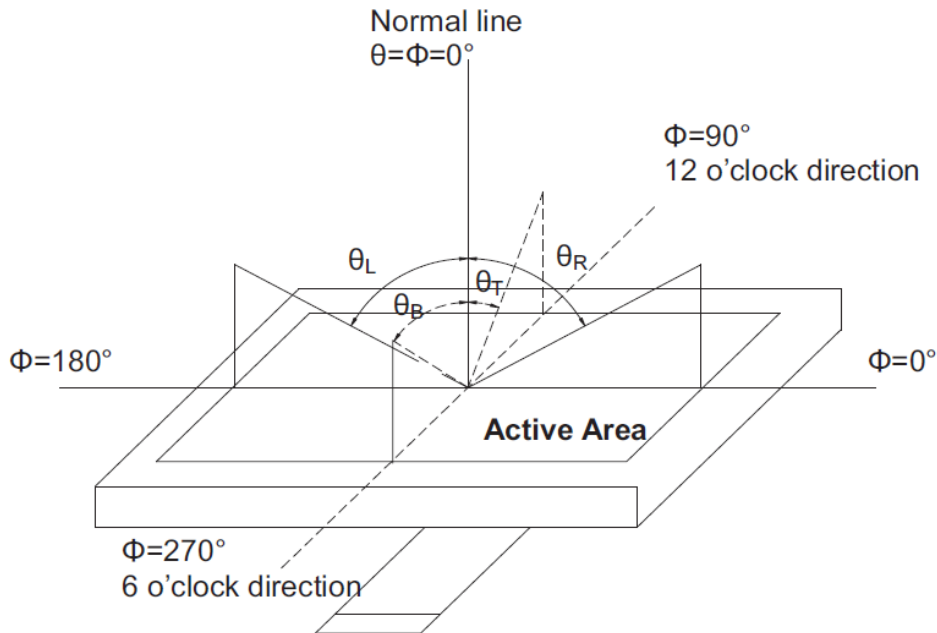

Note 5: Color chromaticity is defined as follow: (CIE1931)

Color coordinates measured at center point of LCD.

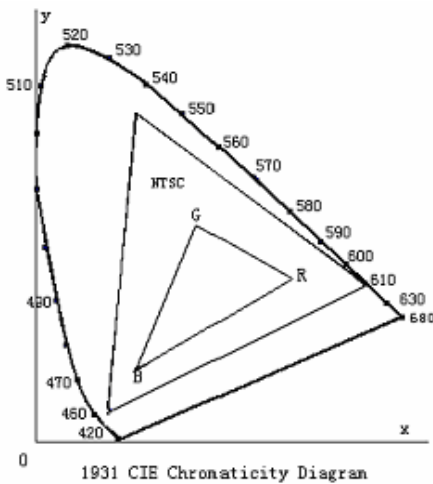

$$S = \frac{\text{area of RGB triangle}}{\text{area of NTSC triangle}} \times 100\%$$

Note 6: Luminance is defined as follow:

Luminance is defined as the brightness of all pixels “White” at the center of display area on optimum contrast.

Note 7: Luminance Uniformity is defined as follow:

Active area is divided into 9 measuring areas (Refer Fig. 2). Every measuring point is placed at the center of each measuring area.

$$\text{Uniformity}(U) = \frac{\text{Minimum Luminance(brightness) in 9 points}}{\text{Maximum Luminance(brightness) in 9 points}}$$

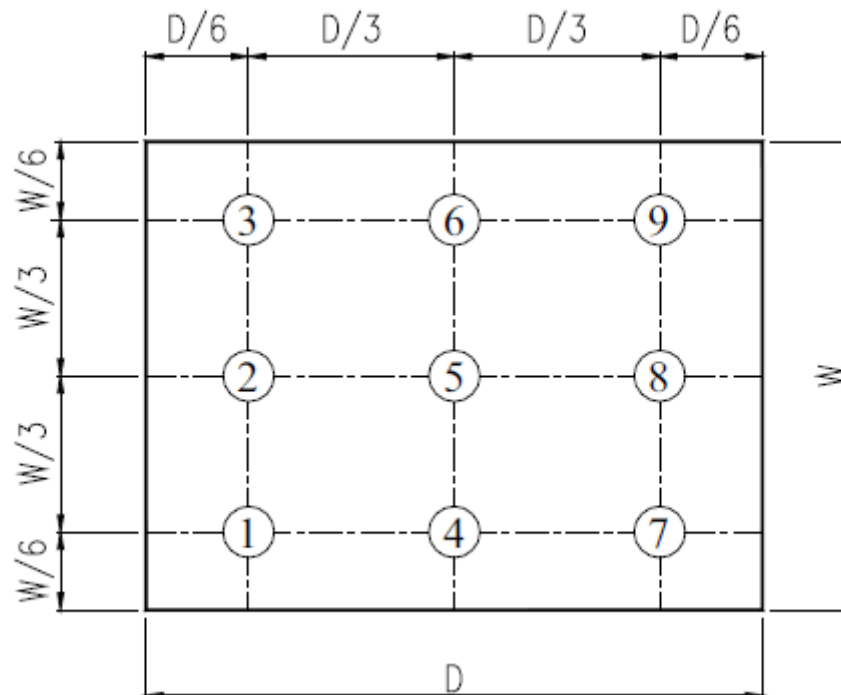

Fig. 2 Definition of uniformity

10. Environmental / Reliability Tests

No	Test Item	Condition	Judgment criteria
1	High Temp Operation	Ta=+70°C, 96hrs	Per table in below
2	Low Temp Operation	Ta=-20°C, 96hrs	Per table in below
3	High Temp Storage	Ta=+80°C, 96hrs	Per table in below
4	Low Temp Storage	Ta=-30°C, 96hrs	Per table in below
5	High Temp & High Humidity Storage	Ta=+60°C, 90% RH 96 hours	Per table in below (polarizer discoloration is excluded)
6	Thermal Shock (Non-operation)	-30°C 30 min~+80°C 30 min, Change time:5min, 5 Cycles	Per table in below
7	ESD (Operation)	Air discharge:+/-8KV, Contact discharge:4KV	Per table in below
8	Vibration (Non-operation)	10Hz~150Hz, 100m/s ² , 120min	Per table in below
9	Shock (Non-operation)	Half- sine wave,300m/s ² ,11ms	Per table in below
10	Package Drop Test	Half- sine wave,300m/s ² ,11ms	Per table in below

INSPECTION	CRITERION(after test)
Appearance	No Crack on the FPC, on the LCD Panel
Alignment of LCD Panel	No Bubbles in the LCD Panel No other Defects of Alignment in Active area
Electrical current	Within device specifications
Function / Display	No Broken Circuit, No Short Circuit or No Black line No Other Defects of Display

11. Precautions for Use of LCD Modules

11.1 Safety

The liquid crystal in the LCD is poisonous. Do not put it in your mouth. If the liquid crystal touches your skin or clothes, wash it off immediately using soap and water.

11.2 Handling

- A. The LCD and touch panel is made of plate glass. Do not subject the panel to mechanical shock or to excessive force on its surface.
- B. Do not handle the product by holding the flexible pattern portion in order to assure the reliability
- C. Transparency is an important factor for the touch panel. Please wear clear finger sacks, gloves and mask to protect the touch panel from finger print or stain and also hold the portion outside the view area when handling the touch panel.
- D. Provide a space so that the panel does not come into contact with other components.
- E. To protect the product from external force, put a covering lens (acrylic board or similar board) and keep an appropriate gap between them.
- F. Transparent electrodes may be disconnected if the panel is used under environmental conditions where dew condensation occurs.
- G. Property of semiconductor devices may be affected when they are exposed to light, possibly resulting in IC malfunctions.
- H. To prevent such IC malfunctions, your design and mounting layout shall be done in the way that the IC is not exposed to light in actual use.

11.3 Static Electricity

- A. Ground soldering iron tips, tools and testers when they are in operation.
- B. Ground your body when handling the products.
- C. Power on the LCD module before applying the voltage to the input terminals.
- D. Do not apply voltage which exceeds the absolute maximum rating.
- E. Store the products in an anti-electrostatic bag or container.

11.4 Storage

- A. Store the products in a dark place at $+25^{\circ}\text{C} \pm 10^{\circ}\text{C}$ with low humidity (40% RH to 60% RH). Don't expose to sunlight or fluorescent light.
- B. Storage in a clean environment, free from dust, active gas, and solvent.

11.5 Cleaning

- A. Do not wipe the touch panel with dry cloth, as it may cause scratch.
- B. Wipe off the stain on the product by using soft cloth moistened with ethanol. Do not allow ethanol to get in between the upper film and the bottom glass. It may cause peeling issue or defective operation. Do not use any organic solvent or detergent other than ethanol.

11.6 Cautions for installing and assembling

- A. Bezel edge must be positioned in the area between the Active area and View area. The bezel may press the touch screen and cause activation if the edge touches the active area. A gap of approximately 0.5mm is needed between the bezel and the top electrode. It may cause unexpected activation if the gap is too narrow. There is a tolerance of 0.2 to 0.3mm for the outside dimensions of the touch panel and tail. A gap must be made to absorb the tolerance in the case and connector.
- B. In order to make the display assembly stable and firm, Displaytech recommends to design some supporting at the display backside, especially for the display with tape-attached touch panel, such supporting is important and essential, or else, the display may drop-off from front after some period of time.
- C. Do not display the fixed pattern for a long time because it may develop image sticking due to the LCD structure. If the screen is displayed with fixed pattern, use a screen saver.

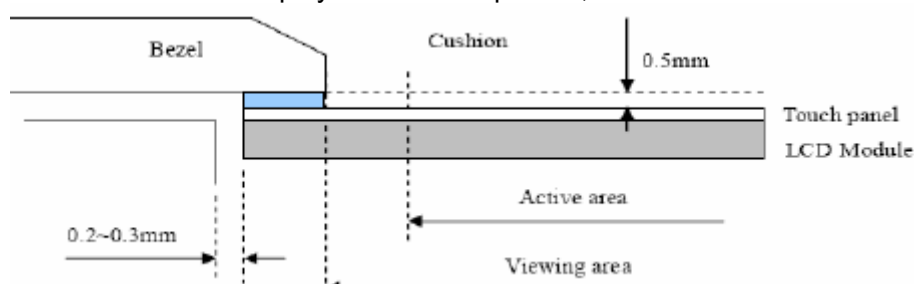

Mouser Electronics

Authorized Distributor

Click to View Pricing, Inventory, Delivery & Lifecycle Information:

[Displaytech:](#)

[DT070DTFT-IPS-HB](#)