

Zener Diodes

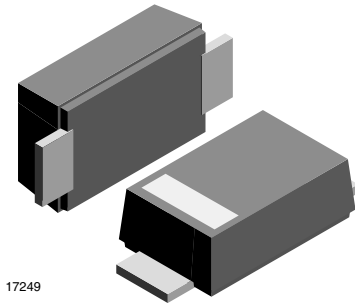

17249

FEATURES

- Silicon planar Zener diodes
- Low profile surface-mount package
- Low leakage current
- Excellent stability
- High temperature soldering: 260 °C/10 s at terminals
- Base P/N-E3 - RoHS-compliant, commercial grade
- Compatible to SOD-123W package case outline or SOD-123F and SOD-123FL
- Material categorization: for definitions of compliance please see www.vishay.com/doc?99912

RoHS
COMPLIANT

LINKS TO ADDITIONAL RESOURCES



3D Models

PRIMARY CHARACTERISTICS		
PARAMETER	VALUE	UNIT
V_Z range nom.	3.6 to 200	V
Test current I_{ZT}	5 to 100	mA
V_Z specification	Pulse current	
Circuit configuration	Single	

ORDERING INFORMATION			
DEVICE NAME	ORDERING CODE	TAPED UNITS PER REEL	MINIMUM ORDER QUANTITY
BZD17 Series	BZD17C3V6P-E3-08 to BZD17C200P-E3-08	3000 per 7" reel (8 mm tape)	30 000/box
	BZD17C3V6P-E3-18 to BZD17C200P-E3-18	10 000 per 13" reel (8 mm tape)	50 000/box

PACKAGE				
PACKAGE NAME	WEIGHT	MOLDING COMPOUND FLAMMABILITY RATING	MOISTURE SENSITIVITY LEVEL	SOLDERING CONDITIONS
SMF (DO-219AB)	15 mg	UL 94 V-0	MSL level 1 (according J-STD-020)	260 °C/10 s at terminals

ABSOLUTE MAXIMUM RATINGS ($T_{amb} = 25\text{ °C}$, unless otherwise specified)				
PARAMETER	TEST CONDITION	SYMBOL	VALUE	UNIT
Power dissipation	$T_L = 80\text{ °C}$	P_{tot}	2300	mW
	$T_A = 25\text{ °C}$ ⁽¹⁾	P_{tot}	800	mW
Non repetitive peak pulse power dissipation ⁽²⁾	100 μ s square pulse	P_{ZSM}	300	W
Junction to lead		R_{thJL}	30	K/W
Junction to ambient air	Mounted on epoxy-glass PCB with 3 mm x 3 mm Cu pads ($\geq 40\text{ }\mu\text{m}$ thick)	R_{thJA}	180	K/W
Junction temperature		T_j	150	°C
Storage temperature range		T_{stg}	-55 to +150	°C
Operating temperature range		T_{op}	-55 to +150	°C

Notes

⁽¹⁾ Mounted on epoxy-glass PCB with 3 mm x 3 mm Cu pads ($\geq 40\text{ }\mu\text{m}$ thick)

⁽²⁾ $T_j = 25\text{ °C}$ prior to surge

**ELECTRICAL CHARACTERISTICS** ($T_{amb} = 25\text{ }^{\circ}\text{C}$, unless otherwise specified)

PART NUMBER	MARKING CODE	ZENER VOLTAGE RANGE ⁽¹⁾			TEST CURRENT	REVERSE CURRENT		DYNAMIC RESISTANCE		TEMPERATURE COEFFICIENT	
		V_Z at I_{ZT1}			I_{ZT1}	I_R at V_R		Z_Z at I_{ZT1}		α_{VZ} at I_{ZT1}	
		V			mA	μA	V	Ω		%/ $^{\circ}\text{C}$	
		MIN.	NOM.	MAX.		MAX.		TYP.	MAX.	MIN.	MAX.
BZD17C3V6P	I0	3.4	3.6	3.8	100	100	1	4	8	-0.14	-0.04
BZD17C3V9P	I1	3.7	3.9	4.1	100	50	1	4	8	-0.14	-0.04
BZD17C4V3P	I2	4	4.3	4.6	100	25	1	4	7	-0.12	-0.02
BZD17C4V7P	I3	4.4	4.7	5	100	10	1	3	7	-0.1	0
BZD17C5V1P	I4	4.8	5.1	5.4	100	5	1	3	6	-0.08	0.02
BZD17C5V6P	I5	5.2	5.6	6	100	10	2	2	4	-0.04	0.04
BZD17C6V2P	I6	5.8	6.2	6.6	100	5	2	2	3	-0.01	0.06
BZD17C6V8P	I7	6.4	6.8	7.2	100	10	3	1	3	0	0.07
BZD17C7V5P	I8	7	7.5	7.9	100	50	3	1	2	0	0.07
BZD17C8V2P	I9	7.7	8.2	8.7	100	10	3	1	2	0.03	0.08
BZD17C9V1P	J0	8.5	9.1	9.6	50	10	5	2	4	0.03	0.08
BZD17C10P	J1	9.4	10	10.6	50	7	7.5	2	4	0.05	0.09
BZD17C11P	J2	10.4	11	11.6	50	4	8.2	4	7	0.05	0.1
BZD17C12P	J3	11.4	12	12.7	50	3	9.1	4	7	0.05	0.1
BZD17C13P	J4	12.4	13	14.1	50	2	10	5	10	0.05	0.1
BZD17C15P	J5	13.8	15	15.6	50	1	11	5	10	0.05	0.1
BZD17C16P	J6	15.3	16	17.1	25	1	12	6	15	0.06	0.11
BZD17C18P	J7	16.8	18	19.1	25	1	13	6	15	0.06	0.11
BZD17C20P	J8	18.8	20	21.2	25	1	15	6	15	0.06	0.11
BZD17C22P	J9	20.8	22	23.3	25	1	16	6	15	0.06	0.11
BZD17C24P	K0	22.8	24	25.6	25	1	18	7	15	0.06	0.11
BZD17C27P	K1	25.1	27	28.9	25	1	20	7	15	0.06	0.11
BZD17C30P	K2	28	30	32	25	1	22	8	15	0.06	0.11
BZD17C33P	K3	31	33	35	25	1	24	8	15	0.06	0.11
BZD17C36P	K4	34	36	38	10	1	27	21	40	0.06	0.11
BZD17C39P	K5	37	39	41	10	1	30	21	40	0.06	0.11
BZD17C43P	K6	40	43	46	10	1	33	24	45	0.07	0.12
BZD17C47P	K7	44	47	50	10	1	36	24	45	0.07	0.12
BZD17C51P	K8	48	51	54	10	1	39	25	60	0.07	0.12
BZD17C56P	K9	52	56	60	10	1	43	25	60	0.07	0.12
BZD17C62P	L0	58	62	66	10	1	47	25	80	0.08	0.13
BZD17C68P	L1	64	68	72	10	1	51	25	80	0.08	0.13
BZD17C75P	L2	70	75	79	10	1	56	30	100	0.08	0.13
BZD17C82P	L3	77	82	87	10	1	62	30	100	0.08	0.13
BZD17C91P	L4	85	91	96	5	1	68	60	200	0.08	0.13
BZD17C100P	L5	94	100	106	5	1	75	60	200	0.09	0.13
BZD17C110P	L6	104	110	116	5	1	82	80	250	0.09	0.13
BZD17C120P	L7	114	120	127	5	1	91	80	250	0.09	0.13
BZD17C130P	L8	124	130	141	5	1	100	110	300	0.09	0.13
BZD17C150P	L9	138	150	156	5	1	110	130	300	0.09	0.13
BZD17C160P	M0	153	160	171	5	1	120	150	350	0.09	0.13
BZD17C180P	M1	168	180	191	5	1	130	180	400	0.09	0.13
BZD17C200P	M2	188	200	212	5	1	150	200	500	0.09	0.13

Notes

- Electrical characteristics when used as regulator diodes
- Maximum $V_F = 1.2\text{ V}$, at $I_F = 0.2\text{ A}$

⁽¹⁾ Pulse test: $t_p \leq 5\text{ ms}$

TYPICAL CHARACTERISTICS ($T_{amb} = 25\text{ }^{\circ}\text{C}$, unless otherwise specified)

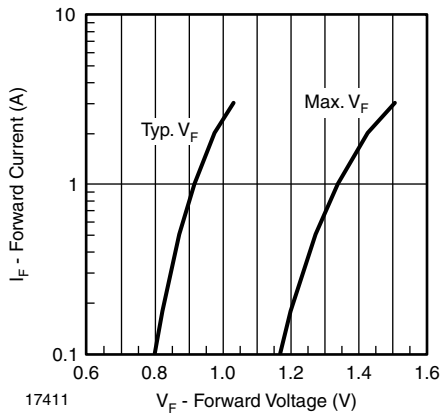

Fig. 1 - Forward Current vs. Forward Voltage

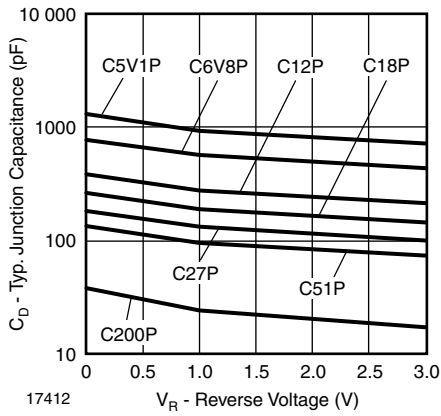

Fig. 2 - Typ. Diode Capacitance vs. Reverse Voltage

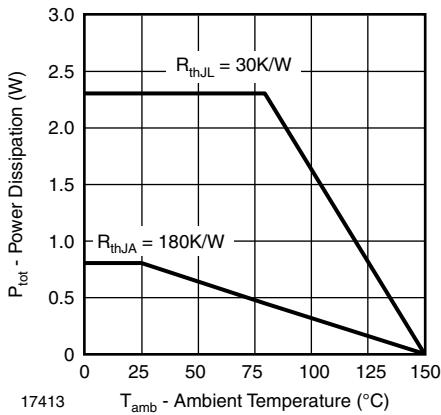
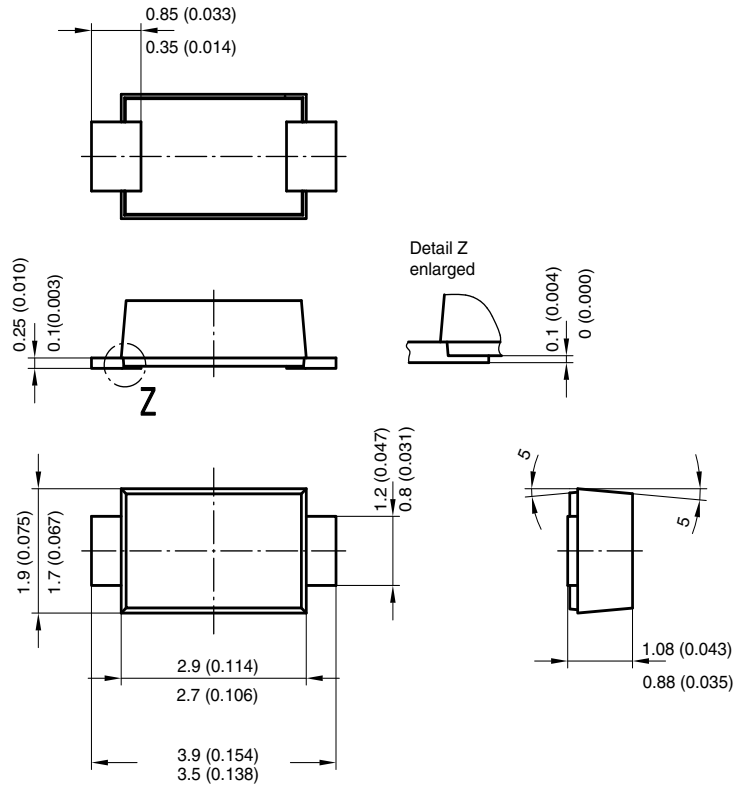

Fig. 3 - Power Dissipation vs. Ambient Temperature



PACKAGE DIMENSIONS in millimeters (inches): SMF (D0219-AB)



Foot print recommendation:

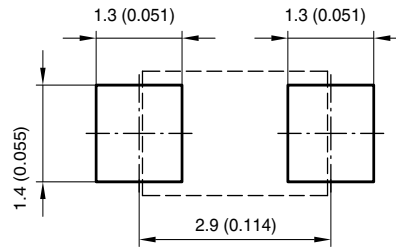

Created - Date: 15. February 2005
 Rev. 3 - Date: 13. March 2007
 Document no.: S8-V-3915.01-001 (4)
 17247

BLISTERTAPE DIMENSIONS FOR SMF in millimeters

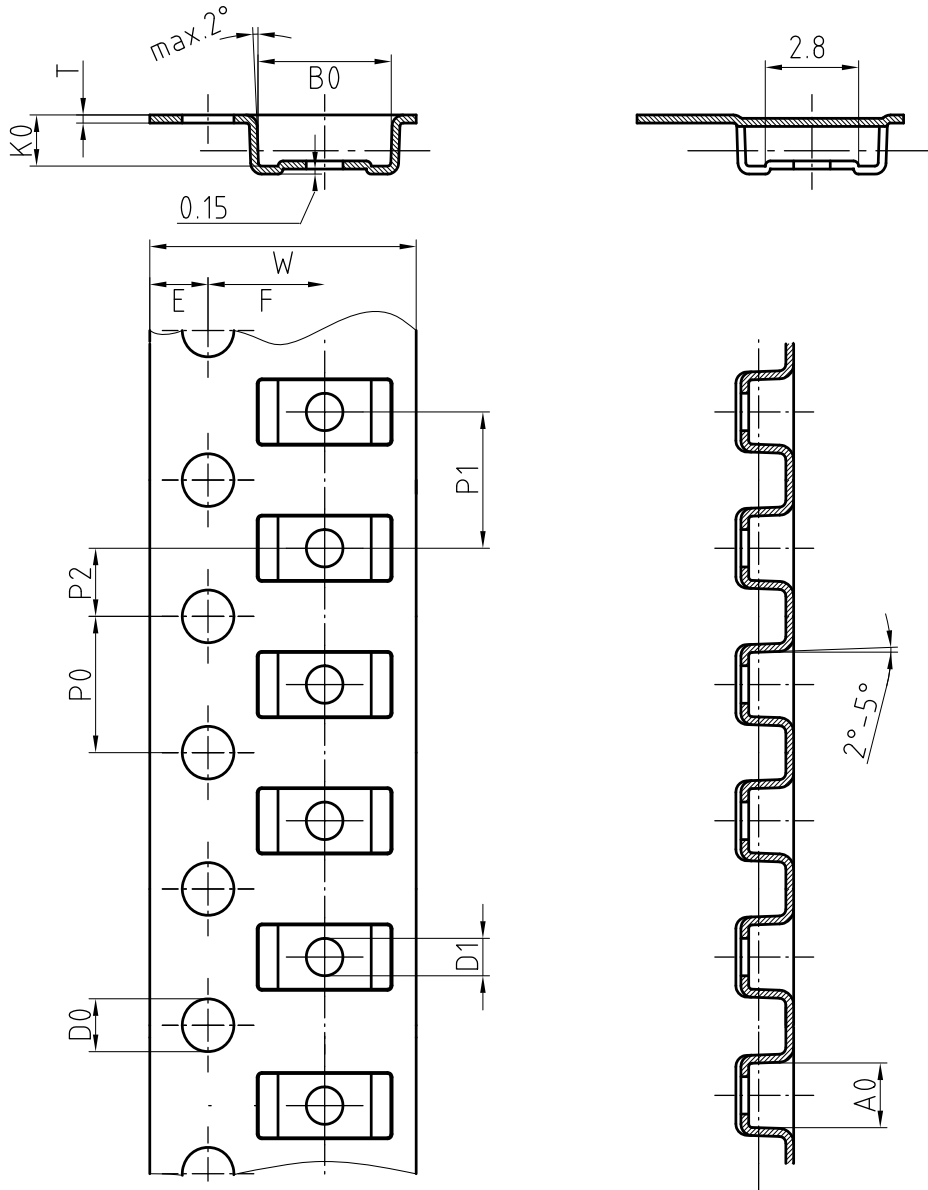

Mat:	A0	B0	K0	W	T	P0	P2	P1	D0	D1	E	F
PS	1.9	4.0	1.5	8.0	0.235	4.0	2.0	4.0	1.5	1	1.75	3.5

Document-No.: S8-V-3717.02-001 (3)

18513



Disclaimer

ALL PRODUCT, PRODUCT SPECIFICATIONS AND DATA ARE SUBJECT TO CHANGE WITHOUT NOTICE TO IMPROVE RELIABILITY, FUNCTION OR DESIGN OR OTHERWISE.

Vishay Intertechnology, Inc., its affiliates, agents, and employees, and all persons acting on its or their behalf (collectively, "Vishay"), disclaim any and all liability for any errors, inaccuracies or incompleteness contained in any datasheet or in any other disclosure relating to any product.

Vishay makes no warranty, representation or guarantee regarding the suitability of the products for any particular purpose or the continuing production of any product. To the maximum extent permitted by applicable law, Vishay disclaims (i) any and all liability arising out of the application or use of any product, (ii) any and all liability, including without limitation special, consequential or incidental damages, and (iii) any and all implied warranties, including warranties of fitness for particular purpose, non-infringement and merchantability.

Statements regarding the suitability of products for certain types of applications are based on Vishay's knowledge of typical requirements that are often placed on Vishay products in generic applications. Such statements are not binding statements about the suitability of products for a particular application. It is the customer's responsibility to validate that a particular product with the properties described in the product specification is suitable for use in a particular application. Parameters provided in datasheets and / or specifications may vary in different applications and performance may vary over time. All operating parameters, including typical parameters, must be validated for each customer application by the customer's technical experts. Product specifications do not expand or otherwise modify Vishay's terms and conditions of purchase, including but not limited to the warranty expressed therein.

Except as expressly indicated in writing, Vishay products are not designed for use in medical, life-saving, or life-sustaining applications or for any other application in which the failure of the Vishay product could result in personal injury or death. Customers using or selling Vishay products not expressly indicated for use in such applications do so at their own risk. Please contact authorized Vishay personnel to obtain written terms and conditions regarding products designed for such applications.

No license, express or implied, by estoppel or otherwise, to any intellectual property rights is granted by this document or by any conduct of Vishay. Product names and markings noted herein may be trademarks of their respective owners.