

SHARP®

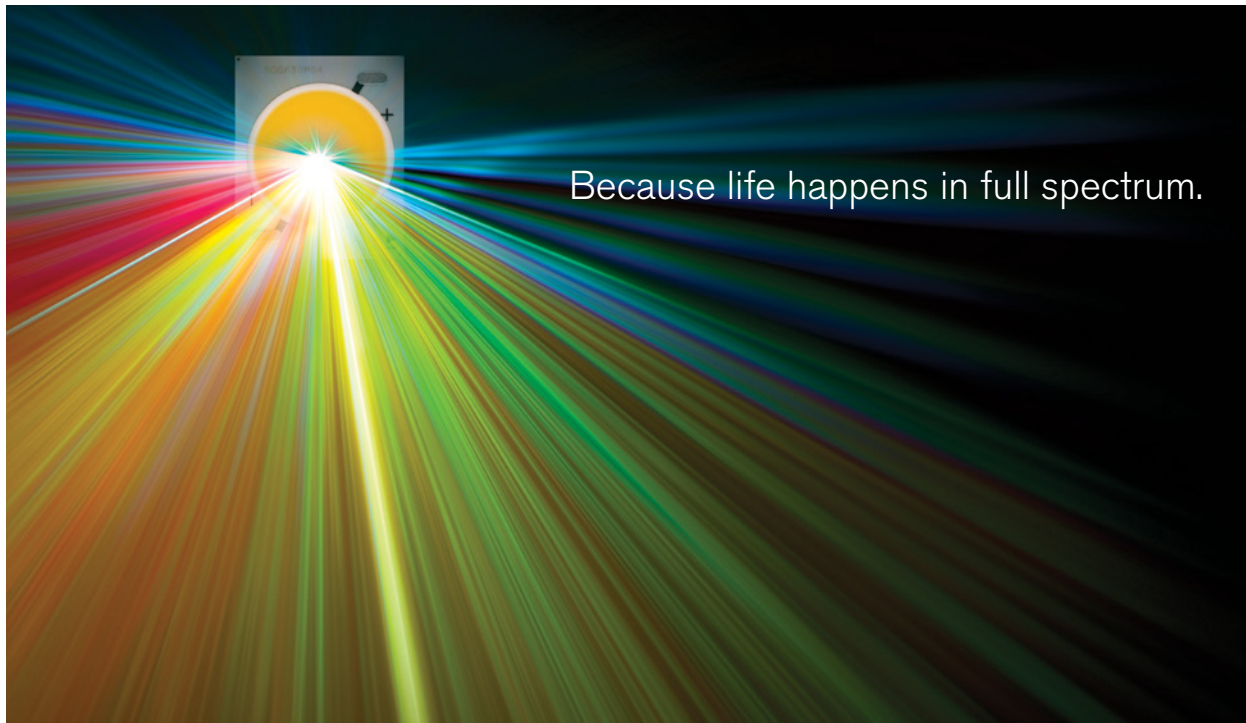

Because life happens in full spectrum.

SHARP ZENIGATA CHIP ON BOARD

2013 LED LINE-UP



Sharp Performance for Any Environment

Lighting often makes the moment, whether it's pumping up the drama or creating an effect so subtle you don't even realize it's stealing the show. Other times, it's all about muscle. Only dependable high brightness lighting need apply...so long as it keeps power consumption to a minimum.

Whatever your need, Sharp's Zenigata COB (Chip on Board) LED family has you covered. Our ever-growing stable of products shines via proprietary Sharp "know-how" to deliver dazzling quality and high performance for your commercial, industrial, and home lighting applications.

- Uniform Light Emitting Surface (LES) = Low color shift when viewed at an angle.
- High Efficacy* and CRI* = Efficiency combined with dazzling light quality.
- Matched LED Forward Voltages/Lumen Outputs = Even light without hot spots.
- Low Lifetime Lumen Loss/Color Shift = 50k operating hours at top performance.
- Consistent Package Size/LES Diameters = Easier product development.

**See product specifications for detail on typical performance ratings.*

One of These IS Like the Other One.

All new Sharp Mega and Mini Zenigata COB LEDs (GW6 Series) now feature:

Single-bin sorting for color consistency, module-to-module and batch-to-batch.

The new series also delivers:

- Testing/Specifying at 90°C = Proven performance at your fixture's operating temperature.
- Enhanced Performance = Updated specs on many Mega and Mini products.
- Four new Mega and Mini Zenigata power classes

Also New in 2013:

Sharp Giga Zenigata and Tiger Zenigata products.

| | Power | PN | CRI |
|----------------|----------|-------------|-----|
| Giga Zenigata | 100W*/** | GW7GAL50SGC | 70 |
| Mega Zenigata | 50W | GW6DMExxNFC | 80 |
| | 50W | GW6DMExxNFC | 90 |
| | 35W* | GW6DMDxxNFC | 80 |
| | 35W* | GW6DGDxxNFC | 90 |
| | 25W | GW6DMCxxNFC | 80 |
| | 25W | GW6DGCxxNFC | 90 |
| | 25W | GW6DACxxNFC | 70 |
| | 15W | GW6DMAxxNFC | 80 |
| | 15W | GW6DGAxxNFC | 90 |
| | 15W | GW6DGAxxNFC | 70 |
| Tiger Zenigata | 25W*/** | GW6TGCBG4FD | 90 |
| Mini Zenigata | 14W* | GW6BMSxxHED | 80 |
| | 14W* | GW6BGSxxHED | 90 |
| | 12W | GW6BMRxxHED | 80 |
| | 12W | GW6BGRxxHED | 90 |
| | 12W | GW6BMJxxHED | 80 |
| | 9W* | GW6BMWxxHED | 80 |
| | 9W* | GW6BGWxxHED | 90 |
| | 7W | GW6BMExxHED | 80 |
| | 6W* | GW6BMGxxHED | 80 |
| | 6W* | GW6BGGxxHED | 90 |

The Mega Zenigata COB

Power-Saving Lighting that Packs a Punch.

Have an application that requires an incandescent, halogen, or compact fluorescent bulb solution? Think again.

The Mega Zenigata COB provides a powerful, energy-saving LED alternative. Use just one LED in a fixture and gain up to 400W of incandescent equivalent light, luminous flux greater than 6000 lm, and high efficacy (high performance modules exceed 100 lm/W).

This year, Sharp introduces a 35W Power Class, as well as 70 CRI LEDs designed specifically for industrial-type lighting.

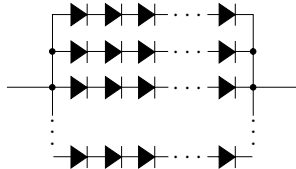
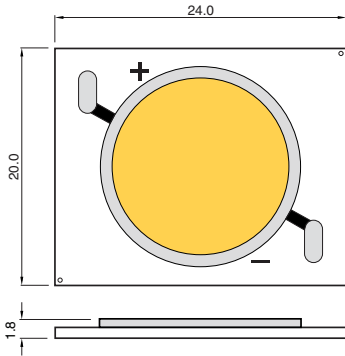

50W: (16 series × 10 parallel) = 160 LEDs

35W: (12 series × 10 parallel) = 120 LEDs

25W: (12 series × 7 parallel) = 84 LEDs

15W: (12 series × 4 parallel) = 48 LEDs

Applications Include:

- High-Intensity Lighting
- Recessed Can Lights
- Architectural Illumination
- Down Lighting
- Spotlights
- Area and Object Lighting
- Replacement Lamp (PAR)

NOTE: Dimensions: mm

Refer to Specifications for full dimensional information

MEGA ZENIGATA

| Type | CRI Ra | | Part No. | CCT (K) | Current (mA) | Voltage (V) | Luminous Flux (lm) | Efficacy (lm/W) |
|--|--------|-------------|-------------|---------|--------------|-------------|--------------------|-----------------|
| | Min. | Typ. | | | | | | |
| 50W - 80W Normal CRI Rjc = 0.8 K/W | 80 | 82 | GW6DME60NFC | 6000 | 1500 | 53.25 | 6931 | 86.8 |
| | | | | | 950 | 50 | 4780 | 100.6 |
| | | | GW6DME50NFC | 5000 | 1500 | 53.25 | 6931 | 86.8 |
| | | | | | 950 | 50 | 4780 | 100.6 |
| | | | GW6DME40NFC | 4000 | 1500 | 53.25 | 6743 | 84.4 |
| | | | | | 950 | 50 | 4650 | 97.9 |
| | 83 | GW6DME35NFC | 3500 | 1500 | 53.25 | 6525 | 81.7 | |
| | | | | 950 | 50 | 4500 | 94.7 | |
| | | GW6DME30NFC | 3000 | 1500 | 53.25 | 6308 | 79.0 | |
| | | | | 950 | 50 | 4350 | 91.6 | |
| | | GW6DME27NFC | 2700 | 1500 | 53.25 | 5989 | 75.0 | |
| | | | | 950 | 50 | 4130 | 86.9 | |
| 50W - 80W High CRI Rjc = 0.8 K/W | 90 | 90 | GW6DGE50NFC | 5000 | 1500 | 53.25 | 5539 | 69.3 |
| | | | | | 950 | 50 | 3820 | 80.4 |
| | | 92 | GW6DGE40NFC | 4000 | 1500 | 53.25 | 5467 | 68.4 |
| | | | | | 950 | 50 | 3770 | 79.4 |
| | | 93 | GW6DGE30NFC | 3000 | 1500 | 53.25 | 5206 | 65.2 |
| | | | | | 950 | 50 | 3590 | 75.6 |
| | | | GW6DGE27NFC | 2700 | 1500 | 53.25 | 4945 | 61.9 |
| | | | | | 950 | 50 | 3410 | 71.8 |

 = Maximum Drive Current  = Typical Drive Current

| Type | CRI Ra | | Part No. | CCT (K) | Current (mA) | Voltage (V) | Luminous Flux (lm) | Efficacy (lm/W) |
|--|--------|------|-------------|---------|--------------|-------------|--------------------|-----------------|
| | Min. | Typ. | | | | | | |
| 35W - 50W Normal CRI R _{jc} = 1.1 K/W | 80 | 82 | GW6DMD60NFC | 6000 | 1300 | 38.5 | 4680 | 93.5 |
| | | | | | 950 | 37 | 3600 | 102.4 |
| | | | GW6DMD50NFC | 5000 | 1300 | 38.5 | 4680 | 93.5 |
| | | | | | 950 | 37 | 3600 | 102.4 |
| | | | GW6DMD40NFC | 4000 | 1300 | 38.5 | 4615 | 92.2 |
| | | | | | 950 | 37 | 3550 | 101.0 |
| | | 83 | GW6DMD35NFC | 3500 | 1300 | 38.5 | 4420 | 88.3 |
| | | | | | 950 | 37 | 3400 | 96.7 |
| | | | GW6DMD30NFC | 3000 | 1300 | 38.5 | 4290 | 85.7 |
| | | | | | 950 | 37 | 3300 | 93.9 |
| | | | GW6DMD27NFC | 2700 | 1300 | 38.5 | 4082 | 81.6 |
| | | | | | 950 | 37 | 3140 | 89.3 |
| 35W - 50W High CRI R _{jc} = 1.1 K/W | 90 | 90 | GW6DGD50NFC | 5000 | 1300 | 38.5 | 3744 | 74.8 |
| | | | | | 950 | 37 | 2880 | 81.9 |
| | | 92 | GW6DGD40NFC | 4000 | 1300 | 38.5 | 3692 | 73.8 |
| | | | | | 950 | 37 | 2840 | 80.8 |
| | | 93 | GW6DGD30NFC | 3000 | 1300 | 38.5 | 3536 | 70.6 |
| | | | | | 950 | 37 | 2720 | 77.4 |
| | | | GW6DGD27NFC | 2700 | 1300 | 38.5 | 3354 | 67.0 |
| | | | | | 950 | 37 | 2580 | 73.4 |

| Type | CRI Ra | | Part No. | CCT (K) | Current (mA) | Voltage (V) | Luminous Flux (lm) | Efficacy (lm/W) |
|--|--------|------|-------------|---------|--------------|-------------|--------------------|-----------------|
| | Min. | Typ. | | | | | | |
| 25W - 40W Normal CRI Rjc = 1.6 K/W | 80 | 82 | GW6DMC60NFC | 6000 | 1050 | 39 | 3780 | 92.3 |
| | | | | | 700 | 37 | 2700 | 104.2 |
| | | | GW6DMC50NFC | 5000 | 1050 | 39 | 3780 | 92.3 |
| | | | | | 700 | 37 | 2700 | 104.2 |
| | | | GW6DMC40NFC | 4000 | 1050 | 39 | 3710 | 90.6 |
| | | | | | 700 | 37 | 2650 | 102.3 |
| | | 83 | GW6DMC35NFC | 3500 | 1050 | 39 | 3542 | 86.5 |
| | | | | | 700 | 37 | 2530 | 97.7 |
| | | | GW6DMC30NFC | 3000 | 1050 | 39 | 3430 | 83.8 |
| | | | | | 700 | 37 | 2450 | 94.6 |
| | | | GW6DMC27NFC | 2700 | 1050 | 39 | 3262 | 79.7 |
| | | | | | 700 | 37 | 2330 | 90.0 |
| 25W - 40W High CRI Rjc = 1.6 K/W | 90 | 90 | GW6DGC50NFC | 5000 | 1050 | 39 | 3024 | 73.8 |
| | | | | | 700 | 37 | 2160 | 83.4 |
| | | 92 | GW6DGC40NFC | 4000 | 1050 | 39 | 2968 | 72.5 |
| | | | | | 700 | 37 | 2120 | 81.9 |
| | | 93 | GW6DGC30NFC | 3000 | 1050 | 39 | 2828 | 69.1 |
| | | | | | 700 | 37 | 2020 | 78.0 |
| | | | GW6DGC27NFC | 2700 | 1050 | 39 | 2688 | 65.6 |
| | | | | | 700 | 37 | 1920 | 74.1 |
| 25W - 40W 70 CRI Rjc = 1.6 K/W | 67 | 70 | GW6DAC60NFC | 6000 | 1050 | 39 | 4200 | 102.6 |
| | | | | | 700 | 37 | 3000 | 115.8 |
| | | | GW6DAC50NFC | 4900 | 1050 | 39 | 4200 | 102.6 |
| | | | | | 700 | 37 | 3000 | 115.8 |
| | | | GW6DAC40NFC | 4000 | 1050 | 39 | 4172 | 101.9 |
| | | | | | 700 | 37 | 2980 | 115.1 |

 = Maximum Drive Current  = Typical Drive Current

| Type | CRI Ra | | Part No. | CCT (K) | Current (mA) | Voltage (V) | Luminous Flux (lm) | Efficacy (lm/W) | | |
|--|--------|------|-------------|---------|--------------|-------------|--------------------|-----------------|------|-------|
| | Min. | Typ. | | | | | | | | |
| 15W - 25W Normal CRI R _{jc} = 2.3 K/W | 80 | 82 | GW6DMA60NFC | 6000 | 700 | 40 | 2480 | 88.6 | | |
| | | | | | 400 | 37 | 1600 | 108.1 | | |
| | | | GW6DMA50NFC | 5000 | 700 | 40 | 2480 | 88.6 | | |
| | | | | | 400 | 37 | 1600 | 108.1 | | |
| | | | GW6DMA40NFC | 4000 | 700 | 40 | 2449 | 87.5 | | |
| | | | | | 400 | 37 | 1580 | 106.8 | | |
| | | 83 | GW6DMA35NFC | 3500 | 700 | 40 | 2325 | 83.0 | | |
| | | | | | 400 | 37 | 1500 | 101.4 | | |
| | | | GW6DMA30NFC | 3000 | 700 | 40 | 2248 | 80.3 | | |
| | | | | | 400 | 37 | 1450 | 98.0 | | |
| | | | GW6DMA27NFC | 2700 | 700 | 40 | 2139 | 76.4 | | |
| | | | | | 400 | 37 | 1380 | 93.2 | | |
| 15W - 25W High CRI R _{jc} = 2.3 K/W | 90 | 90 | GW6DGA50NFC | 5000 | 700 | 40 | 2015 | 72.0 | | |
| | | | | | 400 | 37 | 1300 | 87.8 | | |
| | | | GW6DGA40NFC | 4000 | 700 | 40 | 1969 | 70.3 | | |
| | | | | | 400 | 37 | 1270 | 85.8 | | |
| | | 93 | GW6DGA30NFC | 3000 | 700 | 40 | 1876 | 67.0 | | |
| | | | | | 400 | 37 | 1210 | 81.8 | | |
| | | | GW6DGA27NFC | 2700 | 700 | 40 | 1783 | 63.7 | | |
| | | | | | 400 | 37 | 1150 | 77.7 | | |
| 15W - 25W 70 CRI R _{jc} = 2.3 K/W | 67 | 70 | GW6DAA60NFC | 6000 | 700 | 40 | 2697 | 96.3 | | |
| | | | | | 400 | 37 | 1740 | 117.6 | | |
| | | | | | GW6DAA50NFC | 4900 | 700 | 40 | 2697 | 96.3 |
| | | | | | | | 400 | 37 | 1740 | 117.6 |
| | | | GW6DAA40NFC | 4000 | 700 | 40 | 2620 | 93.6 | | |
| | | | | | 400 | 37 | 1690 | 114.2 | | |

The Mini Zenigata COB

Mini Zenigata COB LEDs offer an ideal solution for retail, restaurants, and other environments where the dazzling color rendering of the Mini Zenigata's 80 – 90 CRI specifications is desired. Mini Zenigata offers a luminous efficacy of up to 100 lm/W in standard operation, and a luminous flux greater than 2000 lm, for fantastic performance and brightness in a small footprint.

This year, Sharp introduces new 14W, 9W, and 6W Power Class products to bring you even more design flexibility. Plus, new in 2013, all Mini Zenigata LEDs have identical light emitting surface diameters, simplifying optical design across the different power classes.

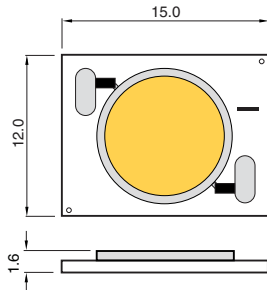

NOTE: Dimensions: mm
Refer to Specifications for full dimensional information

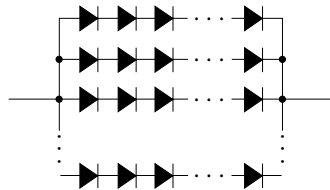

14W: (12 series × 5 parallel) = 60 LEDs
12W: (12 series × 4 parallel) = 48 LEDs
12W: (6 series × 8 parallel) = 48 LEDs
9W: (12 series × 3 parallel) = 36 LEDs
7W: (5 series × 6 parallel) = 30 LEDs
6W: (12 series × 2 parallel) = 24 LEDs

Applications Include:

- Indoor and Outdoor Lighting
- Spotlights
- Reading Lamps
- Sign and Symbol Luminaires
- Mobile Lighting
- Pendant Lights
- Replacement Lamp (A19/PAR)

MINI ZENIGATA

| Type | CRI Ra | | Part No. | CCT (K) | Current (mA) | Voltage (V) | Luminous flux (lm) | Efficacy (lm/W) | |
|--|--|-------------|-------------|-------------|--------------|-------------|--------------------|-----------------|------|
| | Min. | Typ. | | | | | | | |
| 14W - 25W Normal CRI R _{jc} = 2.7 K/W | 80 | 82 | GW6BMS50HED | 5000 | 650 | 37.5 | 2055 | 84.3 | |
| | | | | | 400 | 36 | 1370 | 95.1 | |
| | | | GW6BMS40HED | 4000 | 650 | 37.5 | 2010 | 82.5 | |
| | | | | | 400 | 36 | 1340 | 93.1 | |
| | | | GW6BMS30HED | 3000 | 650 | 37.5 | 1875 | 76.9 | |
| | | | | | 400 | 36 | 1250 | 86.8 | |
| | GW6BMS27HED | 2700 | 650 | 37.5 | 1770 | 72.6 | | | |
| | | | 400 | 36 | 1180 | 81.9 | | | |
| | 14W - 25W High CRI R _{jc} = 2.7 K/W | 87 | 90 | GW6BGS50HED | 5000 | 650 | 37.5 | 1650 | 67.7 |
| | | | | | | 400 | 36 | 1100 | 76.4 |
| 90 | | 92 | GW6BGS40HED | 4000 | 650 | 37.5 | 1620 | 66.5 | |
| | | | | | 400 | 36 | 1080 | 75.0 | |
| | | 93 | GW6BGS30HED | 3000 | 650 | 37.5 | 1560 | 64.0 | |
| | | | | | 400 | 36 | 1040 | 72.2 | |
| | | GW6BGS27HED | 2700 | 650 | 37.5 | 1470 | 60.3 | | |
| | | | | 400 | 36 | 980 | 68.1 | | |

| Type | CRI Ra | | Part No. | CCT (K) | Current (mA) | Voltage (V) | Luminous flux (lm) | Efficacy (lm/W) | |
|--|--|------|-------------|-------------|--------------|-------------|--------------------|-----------------|------|
| | Min. | Typ. | | | | | | | |
| 12W - 19W Normal CRI Rjc = 3.1 K/W | 80 | 82 | GW6BMR50HED | 5000 | 520 | 37 | 1639 | 85.2 | |
| | | | | | 320 | 36 | 1130 | 98.1 | |
| | | | GW6BMR40HED | 4000 | 520 | 37 | 1610 | 83.7 | |
| | | | | | 320 | 36 | 1110 | 96.4 | |
| | | | GW6BMR30HED | 3000 | 520 | 37 | 1494 | 77.6 | |
| | | | | | 320 | 36 | 1030 | 89.4 | |
| | GW6BMR27HED | 2700 | 520 | 37 | 1407 | 73.1 | | | |
| | | | 320 | 36 | 970 | 84.2 | | | |
| | 12W - 19W High CRI Rjc = 3.1 K/W | 87 | 90 | GW6BGR50HED | 5000 | 520 | 37 | 1312 | 68.2 |
| | | | | | | 320 | 36 | 905 | 78.6 |
| | | 90 | 92 | GW6BGR40HED | 4000 | 520 | 37 | 1291 | 67.1 |
| | | | | | | 320 | 36 | 890 | 77.3 |
| 93 | | | GW6BGR30HED | 3000 | 520 | 37 | 1240 | 64.4 | |
| | | | | | 320 | 36 | 855 | 74.2 | |
| GW6BGR27HED | | 2700 | 520 | 37 | 1167 | 60.7 | | | |
| | | | 320 | 36 | 805 | 69.9 | | | |

| | | | | | | | | |
|--|-------------|------|-------------|------|------|------|------|------|
| 12W - 18W Normal CRI Rjc = 3.1 K/W | 80 | 82 | GW6BMJ50HED | 5000 | 900 | 18.5 | 1495 | 89.8 |
| | | | | | 640 | 18 | 1150 | 99.8 |
| | | | GW6BMJ40HED | 4000 | 900 | 18.5 | 1456 | 87.4 |
| | | | | | 640 | 18 | 1120 | 97.2 |
| | | | GW6BMJ30HED | 3000 | 900 | 18.5 | 1352 | 81.2 |
| | | | | | 640 | 18 | 1040 | 90.3 |
| | GW6BMJ27HED | 2700 | 900 | 18.5 | 1287 | 77.3 | | |
| | | | 640 | 18 | 990 | 85.9 | | |

 = Maximum Drive Current  = Typical Drive Current

| Type | CRI Ra | | Part No. | CCT (K) | Current (mA) | Voltage (V) | Luminous flux (lm) | Efficacy (lm/W) |
|---|-------------|------|-------------|---------|--------------|-------------|--------------------|-----------------|
| | Min. | Typ. | | | | | | |
| 9W - 15W Normal CRI R _{jc} = 3.9 K/W | 80 | 82 | GW6BMW50HED | 5000 | 390 | 37 | 1247 | 86.4 |
| | | | | | 240 | 36 | 860 | 99.5 |
| | | | GW6BMW40HED | 4000 | 390 | 37 | 1218 | 84.4 |
| | | | | | 240 | 36 | 840 | 97.2 |
| | GW6BMW30HED | 3000 | 390 | 37 | 1131 | 78.4 | | |
| | | | 240 | 36 | 780 | 90.3 | | |
| | GW6BMW27HED | 2700 | 390 | 37 | 1073 | 74.4 | | |
| | | | 240 | 36 | 740 | 85.6 | | |
| 9W - 15W High CRI R _{jc} = 3.9 K/W | 87 | 90 | GW6BGW50HED | 5000 | 390 | 37 | 1001 | 69.3 |
| | | | | | 240 | 36 | 690 | 79.9 |
| | 90 | 92 | GW6BGW40HED | 4000 | 390 | 37 | 972 | 67.3 |
| | | | | | 240 | 36 | 670 | 77.5 |
| | | 93 | GW6BGW30HED | 3000 | 390 | 37 | 935 | 64.8 |
| | | | | | 240 | 36 | 645 | 74.7 |
| | GW6BGW27HED | 2700 | 390 | 37 | 892 | 61.8 | | |
| | | | 240 | 36 | 615 | 71.2 | | |

| | | | | | | | | |
|---|-------------|------|-------------|-------|-----|-------|------|-------|
| 7W - 13W Normal CRI R _{jc} = 4.5 K/W | 80 | 82 | GW6BME50HED | 5000 | 780 | 15.55 | 1044 | 86.1 |
| | | | | | 480 | 15 | 720 | 100.0 |
| | | | GW6BME40HED | 4000 | 780 | 15.55 | 1015 | 83.7 |
| | | | | | 480 | 15 | 700 | 97.2 |
| | GW6BME30HED | 3000 | 780 | 15.55 | 943 | 77.7 | | |
| | | | 480 | 15 | 650 | 90.3 | | |
| | GW6BME27HED | 2700 | 780 | 15.55 | 899 | 74.1 | | |
| | | | 480 | 15 | 620 | 86.1 | | |

 = Maximum Drive Current  = Typical Drive Current

| Type | CRI Ra | | Part No. | CCT (K) | Current (mA) | Voltage (V) | Luminous flux (lm) | Efficacy (lm/W) |
|---|-------------|------|-------------|---------|--------------|-------------|--------------------|-----------------|
| | Min. | Typ. | | | | | | |
| 6W - 10W Normal CRI Rjc = 5.2 K/W | 80 | 82 | GW6BMG50HED | 5000 | 260 | 37.5 | 834 | 85.5 |
| | | | | | 160 | 36 | 575 | 99.8 |
| | | | GW6BMG40HED | 4000 | 260 | 37.5 | 805 | 82.5 |
| | | | | | 160 | 36 | 555 | 96.4 |
| | GW6BMG30HED | 3000 | 260 | 37.5 | 754 | 77.3 | | |
| | | | 160 | 36 | 520 | 90.3 | | |
| | GW6BMG27HED | 2700 | 260 | 37.5 | 718 | 73.6 | | |
| | | | 160 | 36 | 495 | 85.9 | | |
| 6W - 10W High CRI Rjc = 5.2 K/W | 87 | 90 | GW6BGG50HED | 5000 | 260 | 37.5 | 667 | 68.4 |
| | | | | | 160 | 36 | 460 | 79.9 |
| | 90 | 92 | GW6BGG40HED | 4050 | 260 | 37.5 | 645 | 66.2 |
| | | | | | 160 | 36 | 445 | 77.3 |
| | | 93 | GW6BGG30HED | 3025 | 260 | 37.5 | 624 | 63.9 |
| | | | | | 160 | 36 | 430 | 74.7 |
| | GW6BGG27HED | 2700 | 260 | 37.5 | 595 | 61.0 | | |
| | | | 160 | 36 | 410 | 71.2 | | |

 = Maximum Drive Current  = Typical Drive Current

The Petit Zenigata COB

Tiny Footprint. Big Versatility.

Sharp's Petit Zenigata Chip on Board (COB) LED puts the many benefits of LED lighting technology at your fingertips for design of spot or track lighting solutions. The Petit's small footprint – just 8 mm x 12 mm – packs a big punch, with products in the High CRI line delivering between 300 – 395 lumens. Use fewer modules per fixture to alleviate heat issues and enjoy more design flexibility.

The 9.6V product allows a simple “buck” DC-DC converter to be used for MR16 lamps (which normally require 12V). Higher-voltage 40V parts provide an alternative to traditional line voltage in GU10 lamps.

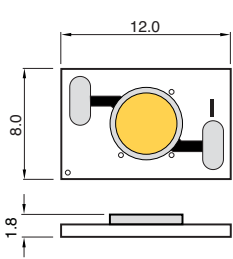

NOTE: Dimensions: mm
Refer to Specifications for full dimensional information

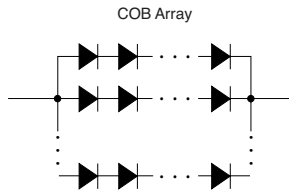

6W: (12 series x 1 parallel) = 12 LEDs
5W: (3 series x 4 parallel) = 12 LEDs
5W: (3 series x 3 parallel) = 9 LEDs
4W: (3 series x 3 parallel) = 9 LEDs
4W: (3 series x 2 parallel) = 6 LEDs

Applications Include:

- Small Track and Spot Lights
- Small Accent Lights
- MR16 and GU10 Replacement Lamps
- Pendant Lights

PETIT ZENIGATA

| Type | CRI Ra | | Part No. | CCT (K) | Current (mA) | Voltage (V) | Luminous flux (lm) | Efficacy (lm/W) | | | |
|---|--------|------|---|---------|--------------|-------------|--------------------|-----------------|------|-----|------|
| | Min. | Typ. | | | | | | | | | |
| SMQ 6W Class Normal CRI Rjc = 11.5 C/W | 80 | 82 | GW5SMQ50P05 | 4850 | 160 | 40.9 | 495 | 75.6 | | | |
| | | | | | 140 | 40 | 450 | 80.4 | | | |
| | | | GW5SMQ40P05 | 3950 | 160 | 40.9 | 495 | 75.6 | | | |
| | | | | | 140 | 40 | 450 | 80.4 | | | |
| | | | GW5SMQ35P05 | 3400 | 160 | 40.9 | 462 | 70.6 | | | |
| | | | | | 140 | 40 | 420 | 75.0 | | | |
| | | | GW5SMQ30P05 | 3000 | 160 | 40.9 | 462 | 70.6 | | | |
| | | | | | 140 | 40 | 420 | 75.0 | | | |
| | | | GW5SMQ27P05 | 2730 | 160 | 40.9 | 429 | 65.6 | | | |
| | | | | | 140 | 40 | 390 | 69.6 | | | |
| | | | SMD 5W Class Normal CRI Rjc = 11.5 C/W | 80 | 82 | GW5SMD50P05 | 4850 | 560 | 9.75 | 469 | 85.8 |
| | | | | | | | | 500 | 9.6 | 430 | 89.6 |
| GW5SMD40P05 | 3950 | 560 | | | | 9.75 | 469 | 85.8 | | | |
| | | 500 | | | | 9.6 | 430 | 89.6 | | | |
| GW5SMD35P05 | 3400 | 560 | | | | 9.75 | 436 | 79.9 | | | |
| | | 500 | | | | 9.6 | 400 | 83.3 | | | |
| GW5SMD30P05 | 3000 | 560 | | | | 9.75 | 436 | 79.9 | | | |
| | | 500 | | | | 9.6 | 400 | 83.3 | | | |
| GW5SMD27P05 | 2730 | 560 | | | | 9.75 | 403 | 73.9 | | | |
| | | 500 | | | | 9.6 | 370 | 77.1 | | | |

 = Maximum Drive Current  = Typical Drive Current

| Type | CRI Ra | | Part No. | CCT (K) | Current (mA) | Voltage (V) | Luminous flux (lm) | Efficacy (lm/W) |
|---|--------|------|-------------|---------|--------------|-------------|--------------------|-----------------|
| | Min. | Typ. | | | | | | |
| SGD 5W Class High CRI R _{jc} = 11.5 K/W | 90 | 92 | GW5SGD50P05 | 4850 | 560 | 9.75 | 391 | 71.5 |
| | | | | | 500 | 9.6 | 360 | 75.0 |
| | | | GW5SGD40P05 | 3950 | 560 | 9.75 | 391 | 71.5 |
| | | | | | 500 | 9.6 | 360 | 75.0 |
| | | | GW5SGD35P05 | 3400 | 560 | 9.75 | 358 | 65.6 |
| | | | | | 500 | 9.6 | 330 | 68.8 |
| | | | GW5SGD30P05 | 3000 | 560 | 9.75 | 358 | 65.6 |
| | | | | | 500 | 9.6 | 330 | 68.8 |
| | | | GW5SGD27P05 | 2730 | 560 | 9.75 | 326 | 59.6 |
| | | | | | 500 | 9.6 | 300 | 62.5 |

| | | | | | | | | |
|---|----|----|-------------|------|-----|------|-----|------|
| SMC 4W Class Normal CRI R _{jc} = 16 K/W | 80 | 82 | GW5SMC50P05 | 4850 | 460 | 9.95 | 352 | 76.9 |
| | | | | | 400 | 9.8 | 320 | 81.6 |
| | | | GW5SMC40P05 | 3950 | 460 | 9.95 | 352 | 76.9 |
| | | | | | 400 | 9.8 | 320 | 81.6 |
| | | | GW5SMC35P05 | 3400 | 460 | 9.95 | 330 | 72.1 |
| | | | | | 400 | 9.8 | 300 | 76.5 |
| | | | GW5SMC30P05 | 3000 | 460 | 9.95 | 330 | 72.1 |
| | | | | | 400 | 9.8 | 300 | 76.5 |
| | | | GW5SMC27P05 | 2730 | 460 | 9.95 | 308 | 67.3 |
| | | | | | 400 | 9.8 | 280 | 71.4 |

| Type | CRI Ra | | Part No. | CCT (K) | Current (mA) | Voltage (V) | Luminous flux (lm) | Efficacy (lm/W) |
|---|-------------|------|-------------|---------|--------------|-------------|--------------------|-----------------|
| | Min. | Typ. | | | | | | |
| 5W Class Normal CRI Rjc = 9.3 C/W | 80 | 82 | GW5SMC60P0C | 6000 | 560 | 10.4 | 451 | 77.4 |
| | | | | | 500 | 10.3 | 410 | 79.6 |
| | | | GW5SMC50P0C | 5000 | 560 | 10.4 | 451 | 77.4 |
| | | | | | 500 | 10.3 | 410 | 79.6 |
| | | | GW5SMC40P0C | 4000 | 560 | 10.4 | 440 | 75.5 |
| | | | | | 500 | 10.3 | 400 | 77.7 |
| | GW5SMC30P0C | 3000 | 560 | 10.4 | 418 | 71.8 | | |
| | | | 500 | 10.3 | 380 | 73.8 | | |
| | GW5SMC27P0C | 2700 | 560 | 10.4 | 385 | 66.1 | | |
| | | | 500 | 10.3 | 350 | 68.0 | | |

| | | | | | | | | |
|---|-------------|------|-------------|------|-------|------|-------|------|
| 4W Class Normal CRI Rjc = 9.3 C/W | 80 | 82 | GW5SMB60P0C | 6000 | 380 | 10.4 | 322.4 | 81.6 |
| | | | | | 350 | 10.3 | 310 | 86.0 |
| | | | GW5SMB50P0C | 5000 | 380 | 10.4 | 322.4 | 81.6 |
| | | | | | 350 | 10.3 | 310 | 86.0 |
| | | | GW5SMB40P0C | 4000 | 380 | 10.4 | 312 | 78.9 |
| | | | | | 350 | 10.3 | 300 | 83.2 |
| | GW5SMB30P0C | 3000 | 380 | 10.4 | 291.2 | 73.7 | | |
| | | | 350 | 10.3 | 280 | 77.7 | | |
| | GW5SMB27P0C | 2700 | 380 | 10.4 | 270.4 | 68.4 | | |
| | | | 350 | 10.3 | 260 | 72.1 | | |

 = Maximum Drive Current  = Typical Drive Current

The Double Dome

Sharp's Linear Lighting Solution

Sharp's specialty Double Dome LED family provides a high-intensity white LED option for area and strip lighting solutions. Its moderate light output cuts down on potential glare compared to higher-wattage LEDs, and a small surface-mountable footprint provides ease of installation.

The one-die Double Dome offers an energy-saving option for very subtle applications, and an LED alternative for "tube-style" lighting (e.g., fluorescent tubes). Two-die Double Domes create elegant lighting for solutions with medium brightness, and the three-die product achieves higher lumen output for maximum brightness.

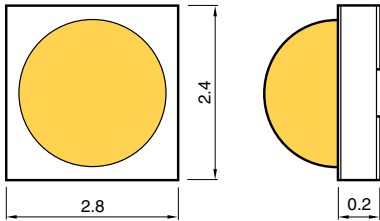

NOTE: Dimensions: mm
Refer to Specifications for full dimensional information

Applications Include

- Strip Lighting
- Accent and Edge Lighting
- Back Lighting
- Refrigerator Case Lighting
- Channel Letter Solutions

DOUBLE DOME

| Type | CRI Ra | | Part No. | CCT (K) | Current (mA) | Voltage (V) | Luminous flux (lm) | Efficacy (lm/W) |
|--|--------|------|-------------|---------|--------------|-------------|--------------------|-----------------|
| | Min. | Typ. | | | | | | |
| Double Dome 0.5W (3 dice) Rjc = 25 K/W | 80 | 83 | GM2BB65QK0C | 6500 | 220 | 3.07 | 68.5 | 101 |
| | | | | | 150 | 2.95 | 50 | 113 |
| | | | GM2BB57QK0C | 5700 | 220 | 3.07 | 71 | 105 |
| | | | | | 150 | 2.95 | 52 | 118 |
| | | | GM2BB50QK0C | 5000 | 220 | 3.07 | 72.5 | 107 |
| | | | | | 150 | 2.95 | 53 | 120 |
| | | | GM2BB45QK0C | 4500 | 220 | 3.07 | 70 | 104 |
| | | | | | 150 | 2.95 | 51 | 115 |
| | | | GM2BB40QK0C | 4000 | 220 | 3.07 | 68.5 | 101 |
| | | | | | 150 | 2.95 | 50 | 113 |
| | | | GM2BB35QK0C | 3500 | 220 | 3.07 | 66 | 98 |
| | | | | | 150 | 2.95 | 48 | 108 |
| | | | GM2BB30QK0C | 3000 | 220 | 3.07 | 63 | 93 |
| | | | | | 150 | 2.95 | 46 | 104 |
| | | | GM2BB27QK0C | 2700 | 220 | 3.07 | 60.5 | 90 |
| | | | | | 150 | 2.95 | 44 | 99 |

 = Maximum Drive Current  = Typical Drive Current

| Type | CRI Ra | | Part No. | CCT (K) | Current (mA) | Voltage (V) | Luminous flux (lm) | Efficacy (lm/W) |
|--|--------|------|-------------|---------|--------------|-------------|--------------------|-----------------|
| | Min. | Typ. | | | | | | |
| Double Dome 0.3W (2 dice) R _{jc} = 33 K/W | 80 | 83 | GM2BB65QKAC | 6500 | 160 | 3.07 | 50.3 | 102 |
| | | | | | 100 | 2.95 | 33.5 | 114 |
| | | | | | 80 | 2.90 | 27.5 | 119 |
| | | | GM2BB57QKAC | 5700 | 160 | 3.07 | 52.5 | 107 |
| | | | | | 100 | 2.95 | 35.0 | 119 |
| | | | | | 80 | 2.90 | 29.0 | 125 |
| | | | GM2BB50QKAC | 5000 | 160 | 3.07 | 53.3 | 108 |
| | | | | | 100 | 2.95 | 35.5 | 120 |
| | | | | | 80 | 2.90 | 29.5 | 127 |
| | | | GM2BB45QKAC | 4500 | 160 | 3.07 | 51.8 | 105 |
| | | | | | 100 | 2.95 | 34.5 | 117 |
| | | | | | 80 | 2.90 | 28.5 | 123 |
| | | | GM2BB40QKAC | 4000 | 160 | 3.07 | 50.3 | 102 |
| | | | | | 100 | 2.95 | 33.5 | 114 |
| | | | | | 80 | 2.90 | 27.5 | 119 |
| | | | GM2BB35QKAC | 3500 | 160 | 3.07 | 48.8 | 99 |
| | | | | | 100 | 2.95 | 32.5 | 110 |
| | | | | | 80 | 2.90 | 27.0 | 116 |
| | | | GM2BB30QKAC | 3000 | 160 | 3.07 | 46.5 | 95 |
| | | | | | 100 | 2.95 | 31.0 | 105 |
| | | | | | 80 | 2.90 | 25.5 | 110 |
| | | | GM2BB27QKAC | 2700 | 160 | 3.07 | 44.3 | 90 |
| | | | | | 100 | 2.95 | 29.5 | 100 |
| | | | | | 80 | 2.90 | 24.5 | 106 |

| Type | CRI Ra | | Part No. | CCT (K) | Current (mA) | Voltage (V) | Luminous flux (lm) | Efficacy (lm/W) |
|---|--------|------|-------------|---------|--------------|-------------|--------------------|-----------------|
| | Min. | Typ. | | | | | | |
| Double Dome 0.2W (1 die) Rjc = 65 K/W | 80 | 83 | GM2BB65QK1C | 6500 | 100 | 3.10 | 31.5 | 102 |
| | | | | | 70 | 3.04 | 23.1 | 109 |
| | | | | | 50 | 2.95 | 17.5 | 119 |
| | | | GM2BB57QK1C | 5700 | 100 | 3.10 | 33.3 | 107 |
| | | | | | 70 | 3.04 | 24.5 | 115 |
| | | | | | 50 | 2.95 | 18.5 | 125 |
| | | | GM2BB50QK1C | 5000 | 100 | 3.10 | 33.3 | 107 |
| | | | | | 70 | 3.04 | 24.5 | 115 |
| | | | | | 50 | 2.95 | 18.5 | 125 |
| | | | GM2BB45QK1C | 4500 | 100 | 3.10 | 32.0 | 103 |
| | | | | | 70 | 3.04 | 23.5 | 110 |
| | | | | | 50 | 2.95 | 17.8 | 121 |
| | | | GM2BB40QK1C | 4000 | 100 | 3.10 | 31.5 | 102 |
| | | | | | 70 | 3.04 | 23.1 | 109 |
| | | | | | 50 | 2.95 | 17.5 | 119 |
| | | | GM2BB35QK1C | 3500 | 100 | 3.10 | 30.2 | 98 |
| | | | | | 70 | 3.04 | 22.2 | 104 |
| | | | | | 50 | 2.95 | 16.8 | 114 |
| | | | GM2BB30QK1C | 3000 | 100 | 3.10 | 29.0 | 93 |
| | | | | | 70 | 3.04 | 21.3 | 100 |
| | | | | | 50 | 2.95 | 16.1 | 109 |
| | | | GM2BB27QK1C | 2700 | 100 | 3.10 | 27.7 | 89 |
| | | | | | 70 | 3.04 | 20.4 | 96 |
| | | | | | 50 | 2.95 | 15.4 | 104 |

 = Maximum Drive Current  = Typical Drive Current

The Color of Life

Life happens in full spectrum. Lighting for many applications – retail, hospitality, architectural, and home are just a few examples – needs to be more than just functional and reliable; it must accurately illuminate the dazzling colors that shape our world, and make objects, people, and places look their absolute best.

Sharp LEDs bring you some of the most true-to-life color rendering available. Products in our Mega Zenigata High CRI line boast up to 93 CRI, meeting or exceeding the ENERGY STAR® minimum requirement (80 CRI).

Still, we recognize that CRI measurement alone is not enough. Sharp LEDs go beyond typical CRI measurements (R1 – R8) with powerful performance up to R15. This includes excellent R9 (deep red) rendering. Accurate, deep reds lend a warm, vibrant aesthetic that will help elevate your lighting products from “efficient” to “unforgettable.”

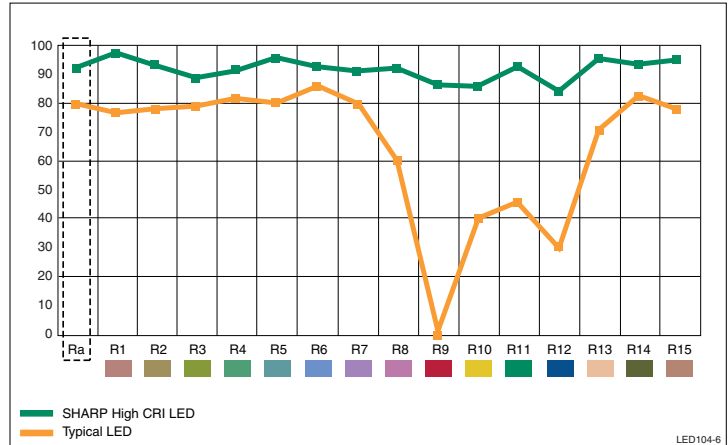



Support

Sharp makes more than 40 years of LED know-how available when you need it most. Our U.S.-based support team includes experts located in your region who can help save you valuable time in the lab and get to market more quickly. Have questions? Sharp answers.

Learn More

Contact your local Sharp representative or Distributor for more information or product samples – or visit www.SharpLEDs.com. Our Resources page will lead you to whitepapers, application notes, Podcasts, product specifications, and information about third party support for reflectors, lenses, and holders.

A Brighter Environmental Outlook

The benefits of LED lighting not only brighten your design; they brighten our world. LEDs are free of hazardous substances such as mercury (Hg). They convert energy to visible light much more efficiently than traditional lighting sources. Plus, an increased operating life (Sharp's modules typically exceed 50k hours of operation, versus a typical 10k hours for a compact fluorescent and 2k hours for an incandescent bulb) means a longer time before LEDs require replacement.



HEADQUARTERS

5700 NW Pacific Rim Blvd.
Camas, WA 98607, U.S.A.
Phone: (1) 360-834-2500
Fax: (1) 360-834-8903
www.sharpsma.com

WESTERN REGION

1980 Zanker Road
San Jose, CA 95112
Phone: (1) 408-436-4900
Fax: (1) 408-436-0924

4 Hutton Center, Suite 800
Santa Ana, CA 92707
Phone: (1) 657-235-3779
Fax: (1) 657-235-3780

EASTERN REGION

200 Wheeler Rd.
Burlington, MA 01803
Phone: (1) 781-270-7979
Fax: (1) 781-229-9117

8000 Regency Parkway, Suite 280
Cary, NC 27518
Phone: (1) 919-460-0695
Fax: (1) 919-460-0795

85 W. Algonquin Road, Suite 280
Arlington Heights, IL 60005
Phone: (1) 847-258-2750
Fax: (1) 847-439-2479

One Towne Square, Suite 200
Southfield, MI 48076
Phone: (1) 248-663-5720
Fax: (1) 248-663-5750