

Chip Inductors for RF Applications / Medical Applications (Wire wound-open)

FASTRON's wire wound chip inductors are designed for radio frequency (RF) applications that require optimal Q on high frequency circuits. Its gold flash pad metallization provides better solderability for a higher yield in production. Additionally, their encapsulation not only protects the winding but also allows for surface mount assembly. It comes in compact sizes (from 0302 to 1812) and is available in reel packaging. Unlisted inductance values are usually available upon request. Ferrite core versions are also available for selected case sizes for applications which require higher inductances in a smaller case size.

Applications Used in LC resonant circuits such as oscillator and signal generators, impedance matching, RF filters etc.
 Mobile Telecommunication: GSM, CDMA, TCDMA, cordless phones, 2 way radio
 Automotive Subsystems: TPMS, Keyless Entry, Anti-Theft, GPS
 Wireless Communication: W-LAN, WIFI, WIMAX, RFID, Bluetooth
 Non-magnetic versions for medical imaging applications: ASM series

Technical Data

L – Value (Rated Inductance)	≥ 1 MHz measured with HP 4286A RF LCR meter or equivalent at frequency f_L , 25°C ambient < 1 MHz measured with HP 4285A or equivalent at frequency f_L , 25°C ambient
Q – Factor (min)	≥ 1 MHz measured with E4991B Impedance Analyzer or equivalent at frequency f_Q , 25°C ambient < 1 MHz measured with HP 4285A or equivalent at frequency f_Q , 25°C ambient
SRF (min)	Measured with HP8753ES Network Analyzer or equivalent at 25°C ambient
DCR (max)	Measured at 25°C ambient
Rated DC Current: Irms	Max permissible current that causes a 15°C component temperature rise from 25°C ambient for AS (except 0302AS), AQ, ASM, F & AF Max permissible current that causes a 30°C component temperature rise from 25°C ambient for 0302AS Max permissible current that causes a 40°C component temperature rise from 25°C ambient for AQC, FLP & LDM
Saturation Current: Isat	Max permissible DC bias at 25°C ambient that causes inductivity drop 30% (typ.) related to the unloaded inductivity for FLP & LDM.
Operating Temperature	-40°C to +100°C (Including component self-heating): F & AF -40°C to +125°C (Including component self-heating): FLP & LDM -40°C to +140°C (Including component self-heating): AS (except 0302AS), AQ, ASM & AQC -40°C to +155°C (Including component self-heating): 0302AS
Surface Finishing	Epoxy molded flat top for perfect pick and place assembly
Pad Metallization	Gold flash as top layer for AS, AQ, F, AF & FLP Silver-Palladium-Platinum for ASM & AQC Tin as top layer for LDM
Wire Termination	Spot welding
Recommended Soldering Method	<u>Reflow</u>
Moisture Sensitivity Levels (MSL)	MSL Level 1, indicating unlimited floor life at ≤ 30°C / 85% relative humidity
Solderability	Using lead-free solder (Sn 99.9) at 260°C ± 5°C for 5 ± 0.5 seconds, min 90% solder coverage of metallization Standard: IEC 68-2-20 (Ta)
Resistance to Soldering Heat	Resistant to 260°C ± 5°C for 10 ± 1 seconds Standard: IEC 68-2-20 (Tb)
Resistance to Solvent	Resistant to isopropyl alcohol for 5 ± 0.5 minutes at 23°C ± 5°C Standard: IEC 68-2-45
Climatic Test	Defined by the following standards: IEC 68-2-1 for Cold test: -55°C for 96 hours IEC 68-2-2 for Dry heat test: +85°C for ferrite core and 125°C for ceramic core for 96 hours IEC 60068-2-78 for Humidity test: 40°C at RH 95% for 4 days
Thermal Shock Test	Temperature cycle (ceramic): -40°C to +125°C to -40°C Temperature cycle (ferrite): -40°C to +85°C to -40°C Max/Min temperature duration: 15 minutes Temperature transition duration: 5 minutes Cycles: 25 Standard: MIL-STD-202G
Adhesion of Soldered Component (Shear Test)	Components withstand a pushing force of 10N for 10 ± 1 seconds Standard: IEC 60068-2-21, method Ue ₃
Mechanical Shock	Mil-Std 202 Method 213, Condition C 3 axis, 6 times, total 18 shocks 100 G, 6 ms, half-sine
Vibration	Mil-Std 202 Method 204 20 mins at 5G 10 Hz to 2000 Hz 12 cycles each of 3 orientations

Chip Inductors for RF Applications / Medical Applications (Wire wound-open)

Ordering Code Example : 0402AS-1N0X-YY → **0402AS-1N0K-01**

0402 AS - 1N0 X - YY
(Case Size) (Core Type) (Inductance Value) (Tolerance) (Packaging Code)

Case Sizes - 0302, 0402, 0603, 0805, 1008, 1206, 1210, 1812

Core Type - AS, AQ, AQC, ASM (Ceramic), F (Ferrite), AF (Ceramic & Ferrite), FLP (Ferrite Low Profile)

Tolerances - F ($\pm 1\%$), G ($\pm 2\%$), A ($\pm 3\%$), J ($\pm 5\%$), K ($\pm 10\%$), L ($\pm 15\%$), M ($\pm 20\%$)

Packaging Code - 01, 04, 08 (Taped / Reel)

Packaging Specification Schematic

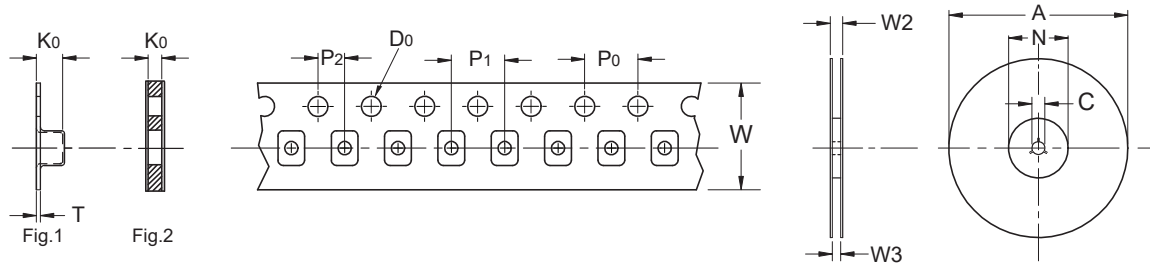

Type	Packaging Code	A	D0	N	C	W2	W3	W	P1	P0	P2	K0	T	Fig
0302	01,08	180	1.55	60	13	11.9	9.5	8	2	4	2	0.50	-	2
0402	01,08	180	1.55	60	13	11.9	9.5	8	2	4	2	0.60	-	2
0603	01,08	180	1.55	60	13	11.4	9.0	8	4	4	2	0.98	-	2
0603	04	330	1.55	100	13	14.4	8.4	8	4	4	2	0.98	-	2
0805	01,08	180	1.55	60	13	11.4	9.0	8	4	4	2	1.63	0.25	1
0805	04	330	1.55	100	13	14.4	8.4	8	4	4	2	1.63	0.25	1
1008	01,08	180	1.50	60	13	11.4	9.5	8	4	4	2	2.23	0.30	1
1008	04	330	1.55	100	13	14.4	8.4	8	4	4	2	1.63	0.25	1
1206	01,08	180	1.50	60	13	18.4	13.7	12	4	4	2	1.80	0.30	1
1206	04	330	1.50	100	13	18.4	12.4	12	4	4	2	1.80	0.30	1
1210	01	180	1.55	60	13	18.4	13.7	12	8	4	2	2.55	0.30	1
1210	04	330	1.55	100	13	18.4	12.4	12	8	4	2	2.55	0.30	1
1812	01	180	1.50	60	13	18.4	13.7	12	8	4	2	3.70	0.35	1
1812	04	330	1.50	100	13	18.4	12.4	12	8	4	2	3.70	0.35	1

0603 AS



Engineer's Kit: EK-0603AS-X

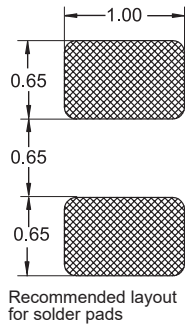
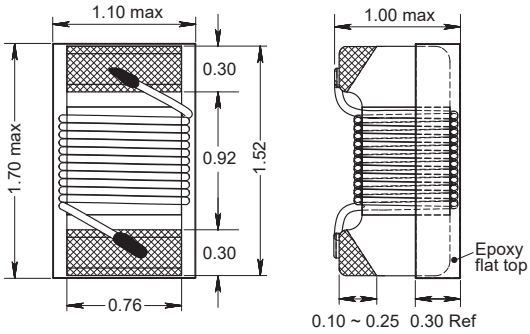
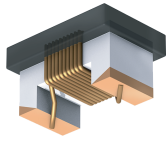

Single layer (typ) EXCEPT #

(Wire wound - open)

Chip Inductors for RF Applications

Part No	Inductance	f _L	Tol	Q	f _Q	SRF	DCR	Rated DC
	L (nH)	(MHz)	± (%)	min	(MHz)	(MHz)	max (Ω)	Current (mA)
0603AS-1N2M-YY	1.2	250	20	30	250	>6000 min	0.030	850
0603AS-1N3M-YY	1.3	250	20	30	250	>6000 min	0.030	850
0603AS-1N5K-YY	1.5	250	10	20	250	>6000 min	0.030	850
0603AS-1N6K-YY	1.6	250	10	20	250	>6000 min	0.030	850
0603AS-1N8K-YY	1.8	250	10	16	250	>6000 min	0.045	700
0603AS-2N0K-YY	2.0	250	10	10	250	5900 min	0.17	170
0603AS-2N2M-YY	2.2	250	20	10	250	5900 min	0.17	170
#0603AS-3N3K-YY	3.3	250	10	22	250	6000 min	0.10	700
0603AS-3N6K-YY	3.6	250	10	20	250	>6000 min	0.08	700
0603AS-3N9K-YY	3.9	250	10	22	250	>6000 min	0.08	700
0603AS-4N3K-YY	4.3	250	10	25	250	>6000 min	0.07	700
0603AS-4N7K-YY	4.7	250	10	25	250	>6000 min	0.07	700
0603AS-5N1K-YY	5.1	250	10	20	250	>6000 min	0.10	700
#0603AS-5N6K-YY	5.6	250	10	27	250	6000 min	0.12	700
0603AS-6N2J-YY	6.2	250	5	25	250	5800 min	0.11	700
0603AS-6N8J-YY	6.8	250	5	27	250	5800 min	0.11	700
0603AS-7N5J-YY	7.5	250	5	30	250	5400 min	0.12	700
0603AS-7N6J-YY	7.6	250	5	30	250	5400 min	0.12	700
0603AS-8N0J-YY	8.0	250	5	30	250	5400 min	0.12	700
0603AS-8N2J-YY	8.2	250	5	30	250	5400 min	0.12	700
0603AS-8N7J-YY	8.7	250	5	28	250	4600 min	0.109	700
0603AS-8N9J-YY	8.9	250	5	25	250	4600 min	0.19	700
0603AS-9N5J-YY	9.5	250	5	25	250	5000 min	0.19	700
0603AS-010J-YY	10	250	5	31	250	4800 min	0.13	700
0603AS-011J-YY	11	250	5	35	250	4000 min	0.13	700
0603AS-012J-YY	12	250	5	35	250	4000 min	0.13	700
0603AS-015J-YY	15	250	5	35	250	4000 min	0.17	700
0603AS-016J-YY	16	250	5	35	250	3200 min	0.17	700
0603AS-018J-YY	18	250	5	35	250	3100 min	0.17	700
0603AS-022J-YY	22	250	5	38	250	3000 min	0.19	700
0603AS-024J-YY	24	250	5	38	250	2800 min	0.22	600
0603AS-027J-YY	27	250	5	40	250	2800 min	0.22	600
0603AS-030J-YY	30	250	5	40	250	2300 min	0.22	600
0603AS-033J-YY	33	250	5	40	250	2300 min	0.22	600
0603AS-036J-YY	36	250	5	40	250	2200 min	0.25	600
0603AS-039J-YY	39	250	5	40	250	2200 min	0.25	600
0603AS-043J-YY	43	250	5	40	250	2000 min	0.28	600
0603AS-047J-YY	47	200	5	38	200	2000 min	0.28	600
0603AS-051J-YY	51	200	5	38	200	1900 min	0.28	600
0603AS-056J-YY	56	200	5	38	200	1900 min	0.31	400
0603AS-068J-YY	68	200	5	37	200	1700 min	0.34	400
0603AS-072J-YY	72	150	5	34	150	1700 min	0.49	400
0603AS-082J-YY	82	150	5	34	150	1700 min	0.54	400
0603AS-090J-YY	90	150	5	34	150	1700 min	0.54	400
0603AS-R10J-YY	100	150	5	34	150	1400 min	0.58	400
0603AS-R11J-YY	110	150	5	34	150	1350 min	0.61	300
0603AS-R12J-YY	120	150	5	34	150	1300 min	0.65	300
0603AS-R13J-YY	130	150	5	32	150	1200 min	0.90	200
0603AS-R15J-YY	150	150	5	32	150	1200 min	0.90	200
0603AS-R18J-YY	180	100	5	32	100	1100 min	1.20	200
0603AS-R20J-YY	200	100	5	30	100	1100 min	1.55	200
0603AS-R22J-YY	220	100	5	30	100	1000 min	1.60	150
* 0603AS-R25J-YY	250	100	5	25	100	950 min	2.30	150
* 0603AS-R27J-YY	270	100	5	25	100	950 min	2.30	150
* 0603AS-R30J-YY	300	100	5	25	100	900 min	2.40	150
* 0603AS-R33J-YY	330	100	5	25	100	600 min	2.50	150
* 0603AS-R39K-YY	390	100	10	25	100	450 min	2.90	150
0603AS-R47K-YY	470	25	10	16	25	230 typ	2.80	150
0603AS-R51K-YY	510	25	10	16	25	150 typ	2.90	150
0603AS-R56K-YY	560	25	10	16	25	150 typ	2.90	150
0603AS-R68K-YY	680	25	10	16	25	140 typ	3.00	140
0603AS-R75K-YY	750	25	10	16	25	320 typ	3.50	130
* 0603AS-R82K-YY	820	25	10	16	25	290 typ	3.70	120
* 0603AS-R91K-YY	910	25	10	16	25	140 typ	3.80	120
* 0603AS-1R0K-YY	1000	25	10	16	25	250 typ	4.00	110
* 0603AS-1R2K-YY	1200	25	10	16	25	140 typ	4.20	100

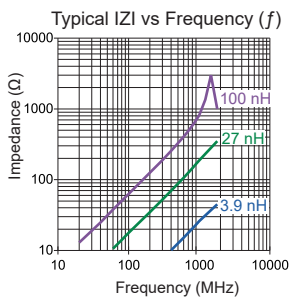
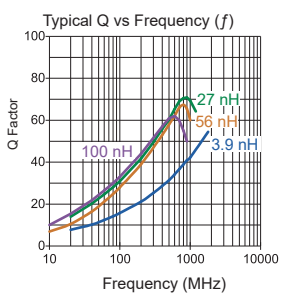
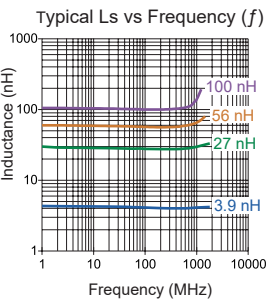

Core Material: Ceramic

SPQ: Taped / Reel 1000 [-08]

4000 [-01]

Remarks:

15000 [-04]

- Unlisted inductance values available upon request.
- 2% and 5% tolerance available upon request.
- All are AEC-Q200 Standard approved EXCEPT *.