

Product Range



Knobs

- **Machined aluminum knobs:** K Series
- **Molded phenolic knobs:** P Series
- **Knob accessories**

Main features:

- Many different designs
- With or without indicator lines and numbers
- Supplied with set screw (anti-vibration feature)
- Shaft hole size adaptors available

K Series, Machined Aluminumpage K2



P Series, Molded Phenolicpage K12



Knob Accessoriespage K21

K Series, Machined Aluminum

Features

- Supplied with Loctite® set-screw (anti-vibration feature)
- With and without indicator line and numbers
- Shaft hole size adaptors available



Typical performance characteristics

Materials machined aluminum
 Set-screw steel
 Finish natural aluminum, or anodizing black
 Adapters brass, with nickel finish
 RoHS Directive 2002/95/EC compliant

Product key		Typical product key				
		K	S	900	B	1/4
Knob Material						
K	machined aluminum					
Type						
blank	3 flute design with and without indicator line					
A	6 flute design with indicator line					
AS	6 flute design with skirt and indicator lines					
B	control knob with straight knurl and top line indicator					
BS	control knob with straight knurl and skirt					
CB	control knob with sawcut indicator					
D	diamond knurl with indicator line					
E	knurl grip with dot indicator					
ES	knurl grip with dot indicator on skirt					
FS	straight knurl with indicator on skirt					
HF	plain body with top and side sawcut indicator					
LN	straight knurl with top and side indicator					
LNS	straight knurl with indicator line on top, side and skirt					
N	straight knurl, with or without spinner, concentric set					
NS	straight knurl with arrowhead indicator on skirt					
PN	straight knurl with pointer and indicator line					
S	3 flute design with skirt and indicator line					
T	square serration with indicator line					
U	serrated diamond trim cut with dot indicator					
US	serrated diamond trim cut with dot indicator and skirt					
Reference diameter						
Series Aluminum						
400	501	700	900	1251		
500	600	701	1250	1755		
Finish						
A	natural aluminum			B	black	
Shaft diameter						
1/8	.126 (3.20mm)		1/4	.251 (6.37mm)		

Note: Product key for reference only, not all combinations are available.

Knobs

K Series, Machined Aluminum (Continued)

K series



K700B1/4

3 flute design with and without indicator line

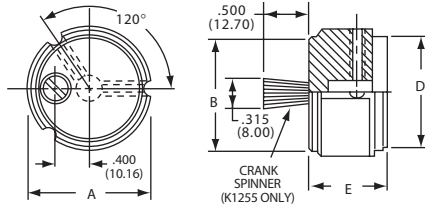

Product key	Version	Color	Dim A	Dim B	Dim D	Dim E	Part Number
K500A1/8	with indicator	natural	12.7 (.500)	10.9 (.430)	10.9 (.430)	15.9 (.625)	1437621-7
K500A1/4	with indicator	natural					1437621-6
K500B1/8	line	black					1437621-9
K500B1/4		black					1437621-8
K700A1/4		natural	18.8 (.740)	16.6 (.655)	16.6 (.655)		1-1437621-0
K700B1/4		black					1-1437621-1
K900A1/4		natural	23.8 (.937)	20.8 (.817)	20.8 (.817)		1-1437621-3
K900B1/4		black					1-1437621-4
K1250A1/4		natural	31.8 (1.25)	28.2 (1.11)	28.2 (1.11)	19.1 (.750)	1437621-2
K1250B1/4		black					1437621-3
K1251B1/4	no indicator						1437621-4
K1255BS1/4	crank spinner*						1437621-5

* with crank spinner, without indicator

KA series



KA500A1/4

6 flute design with indicator line

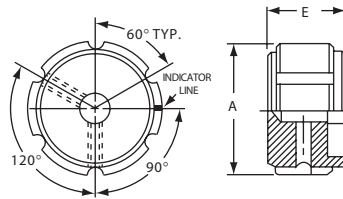

Product key	Version	Color	Dim A	Dim E	Part Number
KA500A1/8	with indicator	natural	12.7 (.500)	15.9 (.625)	2-1437621-0
KA500A1/4	with indicator	natural			1-1437621-9
KA500B1/8	line	black			2-1437621-2
KA500B1/4		black			2-1437621-1
KA700A1/4		natural	19.1 (.750)		2-1437621-3
KA700B1/4		black			2-1437621-4
KA900A1/4		natural	28.8 (.937)		2-1437621-5
KA900B1/4		black			2-1437621-6
KA1250B1/4		black	31.8 (1.25)	19.1 (.750)	1-1437621-8

KAS series



KAS500B1/4

6 flute design with aluminum skirt and indicator lines

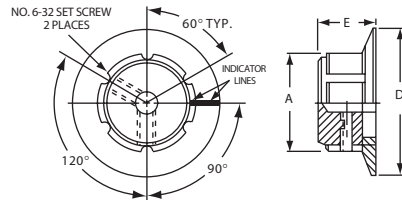

Product key	Version	Color	Dim A	Dim D	Dim E	Part Number
KAS500A1/8	with indicator	natural	12.7 (.500)	18.8 (.740)	16.0 (.630)	2-1437621-8
KAS500A1/4	aluminum	natural				2-1437621-7
KAS500B1/8	skirt	black				3-1437621-0
KAS500B1/4	and indicator	black				2-1437621-9
KAS700A1/4	lines	natural	19.1 (.750)	29.0 (1.14)		3-1437621-1
KAS700B1/4		black				3-1437621-2
KAS900A1/4		natural	23.9 (.940)	35.6 (1.40)		3-1437621-3
KAS900B1/4		black				3-1437621-4

K Series, Machined Aluminum (Continued)

KB series



control knob with straight knurl and top line indicator

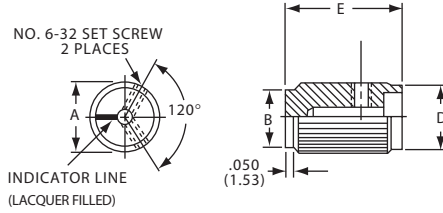

Product key	Color	Dim A	Dim B	Dim D	Dim E	Part Number
KB500A1/8	natural	12.7 (.500)	11.0 (.433)	12.0 (.472)	20.0 (.787)	3-1437621-6
KB500A1/4						3-1437621-5
KB500B1/8	black					3-1437621-9
KB500B1/4						3-1437621-8
KB700A1/4	natural	19.0 (.750)	17.1 (.673)	17.9 (.705)		4-1437621-0
KB700B1/4	black					4-1437621-2
KB900A1/4	natural	23.6 (.930)	22.0 (.866)	22.9 (.902)		4-1437621-4
KB900B1/4	black					4-1437621-5

KBS series



control knob with straight knurl and skirt

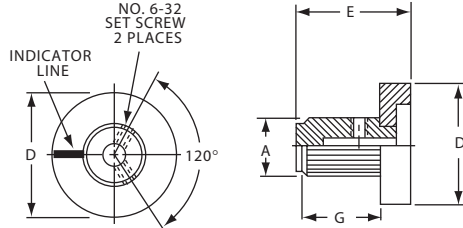

Product key	Version	Color	Dim A	Dim D	Dim E	Part Number
KBS500A101/8	with 0-9	natural	12.7 (.500)	25.4 (1.00)	24.1 (.950)	4-1437621-9
KBS500B101/8	numerals	black				5-1437621-3
KBS500B101/4		black				5-1437621-2
KBS500A1/8	with 0-9	natural				4-1437621-8
KBS500A1/4	indicator	natural				4-1437621-7
KBS500B1/8	line	black				5-1437621-1
KBS500B1/4		black				5-1437621-0

KCB series



control knob with sawcut indicator

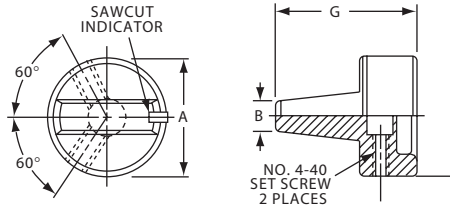

Product key	Color	Dim A	Dim B	Dim D	Dim G	Part Number
KCB500A1/8	natural	12.7 (.500)	5.08 (.197)	3.20 (.126)	19.1 (.750)	5-1437621-7
KCB500A1/4				6.40 (.252)		5-1437621-6
KCB500B1/8	black			3.20 (.126)		5-1437621-9
KCB500B1/4				6.40 (.252)		5-1437621-8
KCB600A1/8	natural	15.7 (.618)		3.20 (.126)		6-1437621-0
KCB600B1/8	black					6-1437621-2
KCB600B1/4				6.40 (.252)		6-1437621-1
KCB700A1/4	natural	18.8 (.746)		6.35 (.250)	22.8 (.898)	6-1437621-3
KCB700B1/4	black					6-1437621-4
KCB900A1/4	natural	23.8 (.937)				6-1437621-5
KCB900B1/4	black					6-1437621-7

K Series, Machined Aluminum (Continued)

KD series



KD1250B1/4

diamond knurl with indicator line

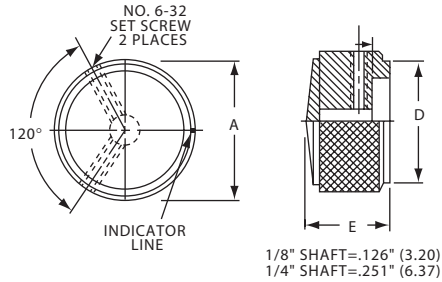

Product key	Color	Dim A	Dim D	Dim E	Part Number
KD500A1/8	natural	12.7 (.500)	10.9 (.430)	16.0 (.630)	7-1437621-1
KD500A1/4					7-1437621-0
KD500B1/8	black				7-1437621-3
KD500B1/4					7-1437621-2
KD700A1/4	natural	19.1 (.750)	16.8 (.660)		7-1437621-4
KD700B1/4	black				7-1437621-5
KD900A1/4	natural	23.9 (.940)	20.8 (.820)		7-1437621-6
KD900B1/4	black				7-1437621-7
KD1250A1/4	natural	31.8 (1.25)	28.2 (1.11)	19.1 (.750)	6-1437621-8
KD1250B1/4	black				6-1437621-9

KE series



KE500AB1/4

KE900AB1/4

knurl grip with top dot indicator

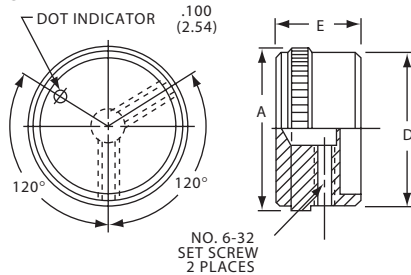

Product key	Color	Dim A	Dim D	Dim E	Part Number
KE500AB1/8	natural -	12.7 (.500)	11.7 (.460)	15.9 (.625)	8-1437621-0
KE500AB1/4	black				7-1437621-9
KE700AB1/4		18.8 (.740)	18.0 (.708)		8-1437621-1
KE900AB1/4		23.8 (.930)	22.9 (.900)		8-1437621-2
KE1250AB1/4		31.8 (1.25)	29.7 (1.17)		7-1437621-8

KES series



KES500AB1/4

knurl grip with dot indicator on skirt

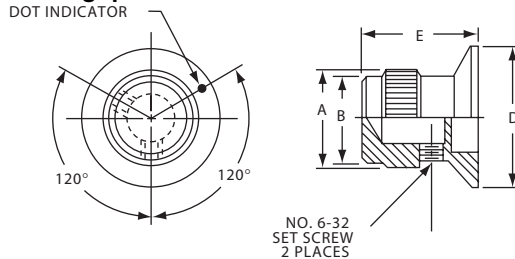

Product key	Color	Dim A	Dim B	Dim D	Dim E	Part Number
KES500AB1/8	natural -	12.7 (.500)	11.7 (.460)	19.1 (.750)	15.9 (.625)	8-1437621-4
KES500AB1/4	black					8-1437621-3
KES700AB1/4		19.1 (.750)	18.1 (.710)	28.7 (1.13)		8-1437621-5

Knobs

K Series, Machined Aluminum (Continued)

KFS series



KFS400B1/8

straight knurl with indicator on skirt

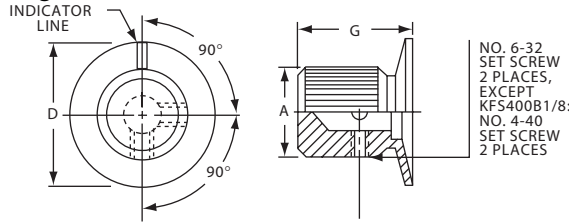

Product key	Color	Dim A	Dim D	Dim G	Part Number
KFS400B1/8	black matte	9.65 (.380)	12.7 (.500)	15.0 (.591)	8-1437621-6
KFS500B1/8		12.7 (.500)	16.0 (.630)	16.0 (.630)	8-1437621-8
KFS500B1/4		15.7 (.618)	25.4 (1.00)	20.6 (.811)	8-1437621-7
KFS600B1/4					8-1437621-9

KHF series



KHF900A1/4

plain body with top and side sawcut indicator

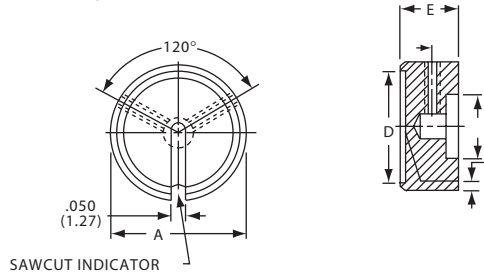

Product key	Color	Dim A	Dim E	Part Number
KHF500A1/4	natural	12.7 (.500)	14.3 (.563)	9-1437621-1
KHF700A1/4		18.8 (.740)		9-1437621-2
KHF900A1/4		23.8 (.937)		9-1437621-3
KHF1250A1/4		31.8 (1.23)		9-1437621-0

KLN series



KLN500A1/4

straight knurl with top and side indicator

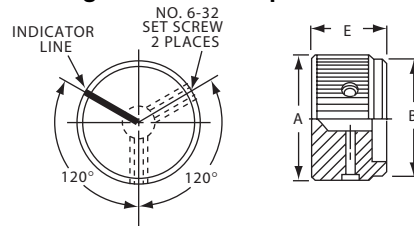

Product key	Color	Dim A	Dim B	Dim E	Part Number
KLN500A1/8	natural	12.7 (.500)	(11. (0.44)	15.9 (.625)	9-1437621-7
KLN500A1/4		12.7 (.500)	(11. (0.44)	15.9 (.625)	9-1437621-6
KLN500B1/8	black	12.7 (.500)	(11. (0.44)	15.9 (.625)	9-1437621-9
KLN500B1/4		12.7 (.500)	(11. (0.44)	15.9 (.625)	9-1437621-8
KLN500S1/4	smoke	12.7 (.500)	(11. (0.44)	15.9 (.625)	1437622-1
KLN700A1/4	natural	18.8 (.740)	17.4 (.685)	15.9 (.625)	1437622-2
KLN700B1/4	black	18.8 (.740)	17.4 (.685)	15.9 (.625)	1437622-3
KLN700B1/8		18.8 (.740)	17.4 (.685)	15.9 (.625)	1437622-4
KLN700S1/4	smoke	18.8 (.740)	17.4 (.685)	15.9 (.625)	1437622-5
KLN900A1/4	natural	23.8 (.937)	22.4 (.882)	15.9 (.625)	1437622-6
KLN900B1/4	black	23.8 (.937)	22.4 (.882)	15.9 (.625)	1437622-7
KLN900S1/4	smoke	23.8 (.937)	22.4 (.882)	15.9 (.625)	1437622-8
KLN1250A1/4	natural	31.8 (1.25)	30.3 (1.19)	15.9 (.625)	9-1437621-4
KLN1250B1/4	black	31.8 (1.25)	30.3 (1.19)	15.9 (.625)	9-1437621-5

K Series, Machined Aluminum (Continued)

KLNS series



KLNS500B/8



KLNS900B/1/4

straight knurl with indicator line on top, side and skirt

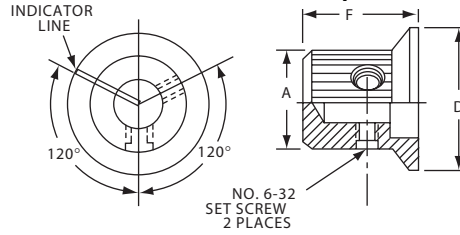

Product key	Color	Dim A	Dim D	Dim F	Part Number
KLNS500A1/8	natural	12.7 (.500)	19.0 (.750)	16.0 (.630)	1-1437622-6
KLNS500A1/4					1-1437622-5
KLNS500B1/8	black				1-1437622-8
KLNS500B1/4					1-1437622-7
KLNS700A1/4	natural	19.0 (.750)	28.7 (1.13)		2-1437622-0
KLNS700B1/4	black				2-1437622-1
KLNS900A1/4	natural	23.9 (.940)	35.5 (1.40)		2-1437622-2
KLNS900B1/4	black				2-1437622-3

KN series



KN501A1/4

straight knurl with arrowhead indicator

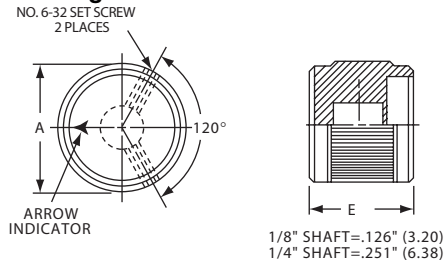

Product key	Version	Color	Dim A	Dim E	Part Number
KN501A1/8	single	natural	12.7 (.500)	15.9 (.625)	5-1437622-1
KN501A1/4	toned	natural			5-1437622-0
KN501B1/8		black			5-1437622-3
KN501B1/4					5-1437622-2
KN701A1/4		natural	19.1 (.750)		6-1437622-2
KN701B1/4		black			6-1437622-3
KN501BA1/8	two	black -	12.7 (.500)		5-1437622-5
KN501BA1/4	toned	natural			5-1437622-4
KN701BA1/8			19.1 (.750)		6-1437622-5
KN701BA1/4					6-1437622-4

KN series



KN1751B1/4



KN1751AS1/4

straight knurl with and without "fingertip" spinner

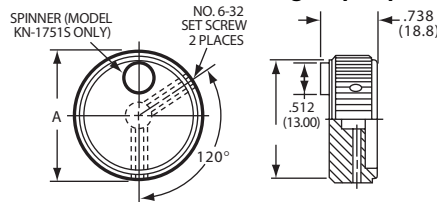

Product key	Version	Color	Dim A	Part Number
KN1751A1/4	without	natural	44.5 (1.75)	3-1437622-2
KN1751B1/4	indicator	black		3-1437622-6
KN1751AB1/4	two	ntl.-blk.		3-1437622-3
KN1751BA1/4	toned	blk.-ntl.		3-1437622-7
KN1750B1/4	with indicator	black		3-1437622-1
KN1751AS1/4	with spinner	natural		3-1437622-5
KN1751BS1/4	without indicator	black		3-1437622-8

Knobs

K Series, Machined Aluminum (Continued)

KN series



KN5700B1/4

concentric set with straight knurl with indicator lines

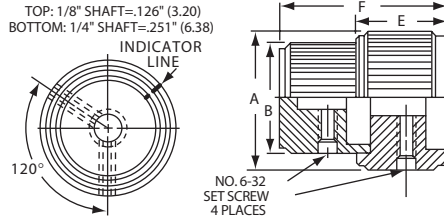

Product key	Color	Dim A	Dim B	Dim E	Dim F	Dim G	Part Number
KN5700A1/4	natural	19.1 (.750)	12.7 (.500)	15.9 (.625)	29.5 (1.16)	7.14 (.281)	5-1437622-6
KN5700B1/4	black						5-1437622-7

KN series



KN500A1/4



KN900BA1/4

straight knurl with and without indicator line

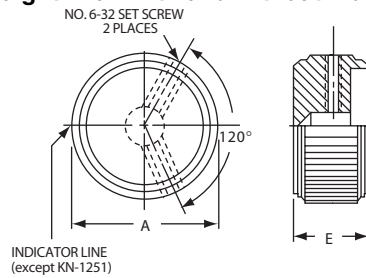

Product key	Version	Color	Dim A	Dim E	Part Number
KN500A1/8	single	natural	12.7 (.500)	15.9 (.625)	4-1437622-3
KN500A1/4	toned				4-1437622-2
KN500B1/8		black			4-1437622-7
KN500B1/4					4-1437622-6
KN700A1/4		natural	19.1 (.750)		5-1437622-8
KN700B1/4		black			6-1437622-0
KN900A1/4		natural	24.1 (.949)		6-1437622-6
KN900B1/4		black			6-1437622-8
KN1250A1/4		natural	31.8 (1.25)		2-1437622-5
KN1250B1/4		black			2-1437622-7
KN500AB1/8	two	ntl.-blk.	12.7 (.500)		4-1437622-5
KN500AB1/4	toned				4-1437622-4
KN500BA1/8		blk.-ntl.			4-1437622-9
KN500BA1/4					4-1437622-8
KN700AB1/4		ntl.-blk.	19.1 (.750)		5-1437622-9
KN700BA1/4		blk.-ntl.			6-1437622-1
KN900AB1/4		ntl.-blk.	24.1 (.949)		6-1437622-7
KN900BA1/4		blk.-ntl.			6-1437622-9
KN1250AB1/4		ntl.-blk.	31.8 (1.25)		2-1437622-6
KN1250BA1/4		blk.-ntl.			2-1437622-8
KN1251A1/4	without	natural			2-1437622-9
KN1251B1/4	indicator	black			3-1437622-0

KN series



straight knurl with "crank" spinner

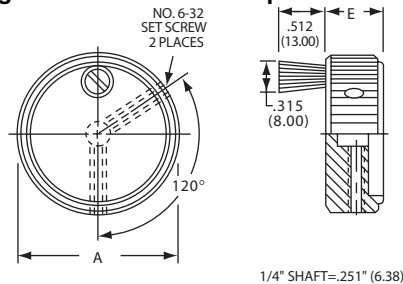

Product key	Color body/spin	Dim A	Dim E	Part Number
KN1755BS1/4	black	44.7 (1.76)	16.0 (.630)	4-1437622-1
KN1755ABS1/4	ntl.-blk./blk.			3-1437622-9
KN1755BAS1/4	blk.-ntl./blk.			4-1437622-0

K Series, Machined Aluminum (Continued)

KNS series

straight knurl with arrowhead indicator on skirt

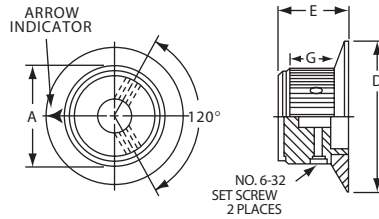

Product key	Version	Color	Dim A	Dim D	Dim E	Dim G	Part Number
KNS501A1/8	single	natural	12.7 (.500)	19.1 (.750)	15.9 (.625)	10.9 (.428)	7-1437622-3
KNS501A1/4	toned						7-1437622-2
KNS501B1/8		black					7-1437622-5
KNS501B1/4							7-1437622-4
KNS701A1/4		natural	19.1 (.750)	28.5 (1.12)			7-1437622-8
KNS701B1/4		black					7-1437622-9
KNS501BA1/8	two	blk.-ntl.	12.7 (.500)	19.1 (.750)			7-1437622-7
KNS501BA1/4	toned						7-1437622-6
KNS701BA1/8			19.1 (.750)	28.5 (1.12)			8-1437622-1
KNS701BA1/4							8-1437622-0

KPN series

straight knurl with pointer and indicator line

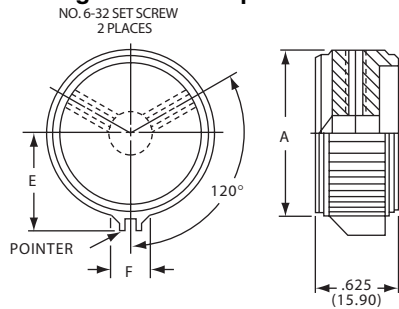

1/8" SHAFT=.126" (3.20)
1/4" SHAFT=.251" (6.38)

Product key	Color	Dim A	Dim E	Dim F	Part Number
KPN500A1/8	natural	12.7 (.500)	9.35 (.368)	4.95 (.195)	9-1437622-1
KPN500A1/4					9-1437622-0
KPN500B1/8	black				9-1437622-3
KPN500B1/4					9-1437622-2
KPN700A1/4	natural	19.1 (.750)	13.1 (.515)	5.94 (.234)	9-1437622-5
KPN700B1/4	black				9-1437622-6
KPN900A1/4	natural	23.8 (.937)	16.0 (.630)	7.01 (.276)	9-1437622-7
KPN900B1/4	black				9-1437622-9

K Series, Machined Aluminum (Continued)

KS series

3 flute design with aluminum skirt and indicator line

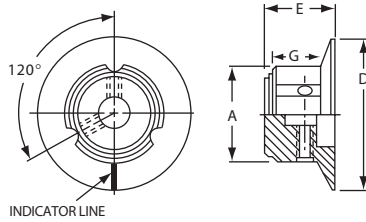

1/4" SHAFT=.251" (6.37)



Product key	Color	Dim A	Dim D	Dim E	Dim G	Part Number
KS500A1/8	natural	12.7 (.500)	19.1 (.750)	15.8 (.620)	10.9 (.430)	1437623-3
KS500A1/4	natural					1437623-2
KS500B1/8	black					1437623-5
KS500B1/4	black					1437623-4
KS700A1/4	natural	19.0 (.750)	28.4 (1.12)			1437623-6
KS700B1/4	black					1437623-7
KS900A1/4	natural	23.9 (.940)	35.6 (1.40)			1437623-8
KS900B1/4	black					1437623-9

KT series

square separation with indicator line

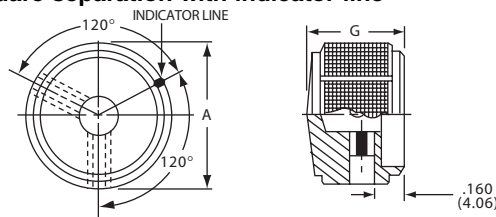

Product key	Color	Dim A	Dim G	Part Number
KT500A1/4	natural	12.7 (.500)	16.0 (.630)	1-1437623-2
KT500B1/8	black			1-1437623-4
KT500B1/4	black			1-1437623-3
KT700A1/4	natural	18.8 (.740)		1-1437623-6
KT700B1/4	black			1-1437623-7
KT900A1/4	natural	23.9 (.940)		1-1437623-8
KT900B1/4	black			1-1437623-9

KU series

serrated diamond trim cut with dot indicator

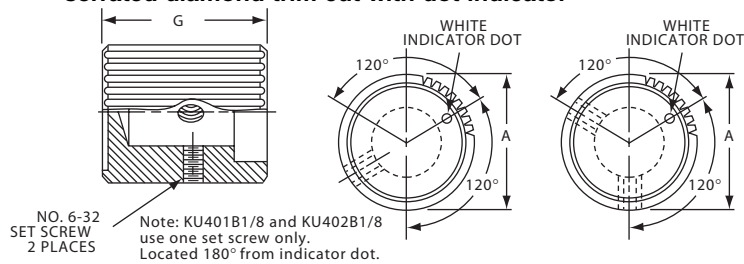

Product key	Color	Dim A	Dim G	Part Number
KU401B1/8	black	9.50 (.374)	7.60 (.299)	2-1437623-1
KU402B1/8	black		11.4 (.449)	2-1437623-2
KU500B1/8		12.7 (.500)	15.2 (.598)	2-1437623-3
KU700B1/4		18.8 (.740)		2-1437623-4

K Series, Machined Aluminum (Continued)

KUS series



serrated diamond trim cut with dot indicator

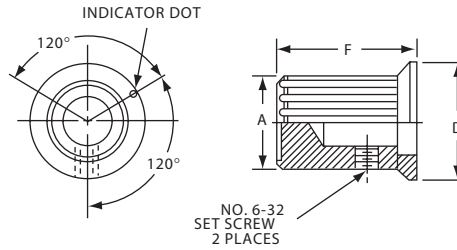

Product key	Color	Dim A	Dim D	Dim F	Part Number
KUS402B1/8	black	9.50 (.374)	13.2 (.520)	11.4 (.450)	2-1437623-9
KUS500B1/8		12.7 (.500)	17.8 (.700)	15.2 (.600)	3-1437623-0
KUS700B1/4		18.8 (.740)	26.2 (1.03)		3-1437623-1

P Series, Molded Phenolic

Features

- Supplied with Loctite® set-screw (anti-vibration feature)
- With and without indicator line and numbers
- Shaft hole size adaptors available



Typical performance characteristics

Material theroset phenolic
 Molded in bushing insert brass
 Set-screw steel
 Skirt aluminum
 End plate spun aluminum
 Finish phenolic black
 Adapters brass, with nickel finish
 RoHS Directive 2002/95/EC compliant

Product key		Typical product key				
		P	K	50	B	1/4
Knob Material						
P	phenolic					
Type						
H	straight knurl without indicator line					
K	straight knurl with dot indicator on skirt or on top					
KA	ribbed with line indicator on skirt					
KAP	ribbed with skirt and pointer with indicator line					
KB	fluted with indicator line on skirt					
KD	straight knurl with skirt and error indicator or numerals					
KDT	black spin cap with "diamond cut" and arrow indicator or numerals					
KE	fluted with indicator line					
KES	fluted with skirt and indicator line					
KF	plain quadrate with indicator line and arrow					
KG	ribbed with indicator line					
KGP	ribbed with bar pointers and indicator line					
KJ	straight knurl with bar pointers and indicator line					
KJT	straight knurl with bar pointer and indicator line and aluminum spin cap					
KN	line indicator on natural aluminum spin cap					
KNT	black spin cap with "diamond cut" without indicator					
KS	straight knurl with indicator line or numerals on skirt					
KX	ribbed body, matte finish with square indicator on top					
Reference diameter						
Series Phenolic						
50	90	130	1103	1132		
55	100	140	1104	1255		
60	110	150	1105			
70	120	1100	1106			
Finish						
A	B	black				
Shaft diameter						
1/8	.126 (3.20mm)	1/4	.251 (6.37mm)			

Note: Product key for reference only, not all combinations are available.

Knobs

P Series, Molded Phenolic (Continued)

PH series

straight knurl without indicator line



PH15181/4

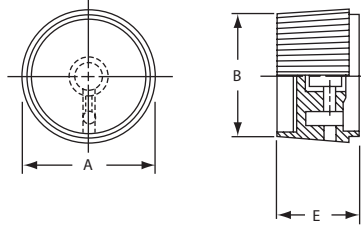

Product key	Dim A	Dim B	Dim E	Part Number
PH15181/4	25.3 (.996)	24.7 (.972)	17.0 (.669)	1437624-2

PK series

straight knurl with dot indicator on skirt



PK50B1/8

PK70B1/4

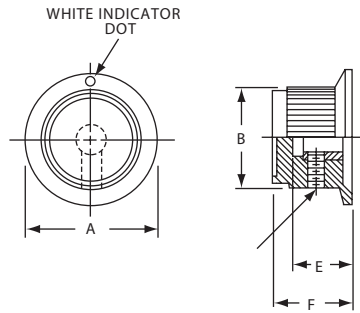

Product key	Dim A	Dim B	Dim E	Dim F	Part Number
PK50B1/8	19.0 (.748)	14.5 (.570)	11.7 (.460)	13.9 (.550)	1437624-7
PK50B1/4					1437624-6
PK70B1/4	25.0 (.984)	18.5 (.728)	12.7 (.500)	14.9 (.590)	1437624-8
PK90B1/4	31.8 (1.25)	25.0 (.985)	11.9 (.470)	15.1 (.595)	1437624-9

PK series

straight knurl with dot indicator on top



PK1100B1/4

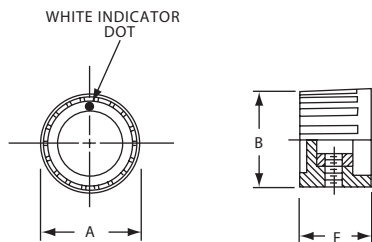

Product key	Version	Color	Dim A	Dim B	Dim F	Part Number
PK1100B1/8		natural	17.8 (.700)	16.3 (.643)	13.5 (.530)	1437624-4

P Series, Molded Phenolic (Continued)

PKA series

ribbed with line indicator on skirt

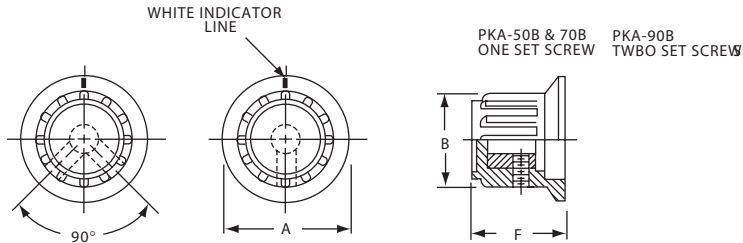

Product key	Dim A	Dim B	Dim F	Part Number
PKA50B1/8	20.2 (.795)	14.7 (.580)	15.0 (.590)	1-1437624-1
PKA50B1/4				1-1437624-0
PKA55B1/8	19.8 (.780)		17.2 (.675)	1-1437624-4
PKA55B1/4				1-1437624-3
PKA70B1/4	24.9 (.980)	18.8 (.740)	19.1 (.750)	1-1437624-5
PKA90B1/4	34.9 (1.375)	24.6 (.970)	21.3 (.840)	1-1437624-7

PKAP series

ribbed with skirt and pointer with indicator line

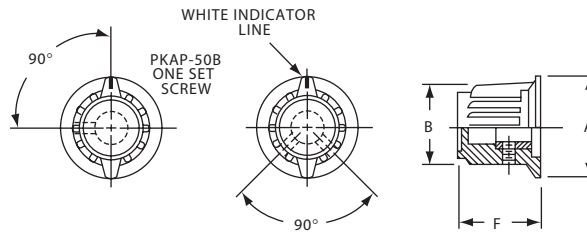

Product key	Dim A	Dim B	Dim F	Part Number
PKAP50B1/4	20.0 (.787)	17.6 (.693)	17.5 (.689)	1-1437624-8
PKAP50B1/8				1-1437624-9
PKAP70B1/4	24.8 (.976)	22.1 (.874)	18.7 (.737)	2-1437624-0

PKB series

fluted with indicator line on skirt

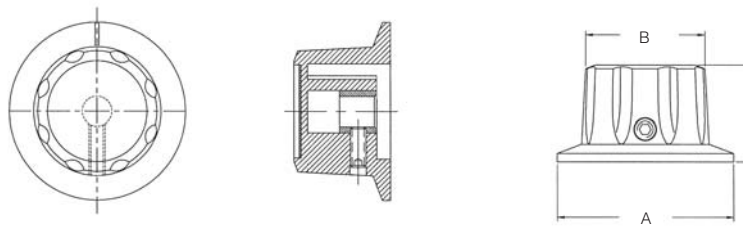

Product key	Dim A	Dim B	Dim F	Part Number
PKB70B1/4	28.3 (1.12)	19.1 (.750)	15.2 (.600)	2-1437624-3
PKB90B1/4	38.1 (1.50)	25.8 (1.02)	20.8 (.820)	2-1437624-4

P Series, Molded Phenolic (Continued)

PKD series

straight knurl, aluminum skirt with arrow indicator or numerals

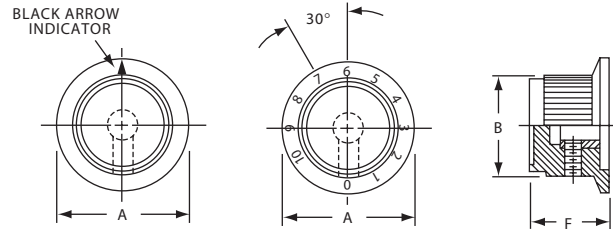

Product key	Version	Dim A	Dim B	Dim F	Part Number
PKD60B1/8	with	19.8 (.780)	14.4 (.566)	14.3 (.563)	2-1437624-8
PKD60B1/4	arrow				2-1437624-7
PKD70B1/4	indicator	25.9 (1.02)	19.1 (.750)	15.5 (.610)	3-1437624-1
PKD100B1/4		32.8 (1.29)	25.4 (1.00)	15.0 (.590)	2-1437624-5
PKD60B101/8	with	19.8 (.780)	14.4 (.566)	14.3 (.563)	3-1437624-0
PKD60B101/4	0 - 10				2-1437624-9
PKD70B101/4	numerals	25.9 (1.02)	19.1 (.750)	15.5 (.610)	3-1437624-2
PKD100B101/4		32.8 (1.29)	25.4 (1.00)	15.0 (.590)	2-1437624-6

PKDT series

black spin cap with "diamond cut" and arrow indicator or numerals

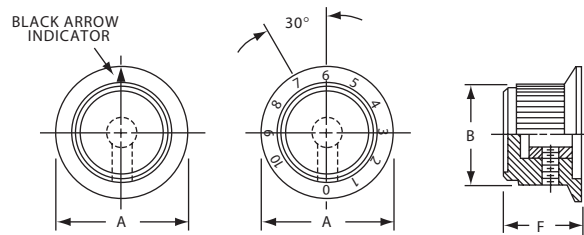

Product key	Version	Dim A	Dim B	Dim F	Part Number
PKDT70B1/4	arrow	26.0 (1.03)	18.8 (.738)	16.1 (.635)	3-1437624-9
PKDT100B1/4	indicator	32.8 (1.29)	25.9 (1.02)	16.2 (.638)	3-1437624-3
PKDT60B101/8	0 - 10	19.8 (.778)	15.4 (.605)	14.3 (.562)	3-1437624-8
PKDT70B101/4	numerals	26.0 (1.03)	18.8 (.738)	16.1 (.635)	4-1437624-0
PKDT100B101/4		32.8 (1.29)	25.9 (1.02)	16.2 (.638)	3-1437624-4

PKE series

fluted with indicator line

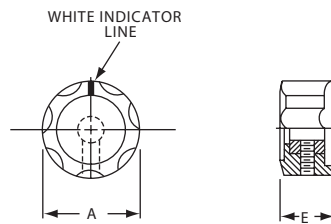

Product key	Dim A	Dim B	Dim F	Part Number
PKE60B1/8	15.9 (.626)	12.0 (.472)	16.1 (.635)	4-1437624-4
PKE60B1/4	15.9 (.626)	12.0 (.472)	16.2 (.638)	4-1437624-3
PKE90B1/4	22.6 (.890)	18.4 (.724)	14.3 (.562)	4-1437624-5

P Series, Molded Phenolic (Continued)

PKES series



fluted with skirt and indicator line

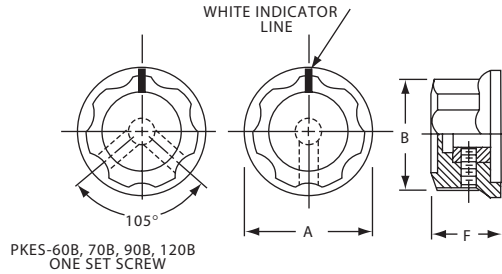

Product key	Dim A	Dim B	Dim F	Part Number
PKES60B1/8	19.0 (.748)	15.7 (.618)	11.9 (.470)	5-1437624-1
PKES60B1/4				5-1437624-0
PKES70B1/4	21.7 (.855)	18.9 (.744)	13.4 (.526)	5-1437624-2
PKES90B1/4	25.7 (1.01)	22.6 (.889)	14.5 (.570)	5-1437624-3
PKES120B1/4	32.9 (1.30)	29.5 (1.16)	16.0 (.628)	4-1437624-6
PKES140B1/4	38.1 (1.50)	34.9 (1.37)	17.6 (.693)	4-1437624-7
PKES150B1/4	44.9 (1.77)	39.4 (1.55)	21.1 (.831)	4-1437624-8

PKF series



plain quadrate with indicator line and arrow

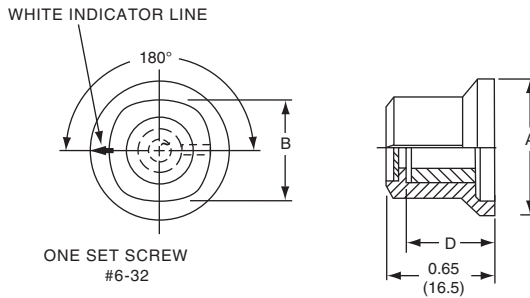

Product key	Dim A	Dim B	Dim D	Part Number
PKF50B1/8	17.0 (.670)	11.5 (.454)	13.2 (.520)	5-1437624-5

PKG series



ribbed with indicator line

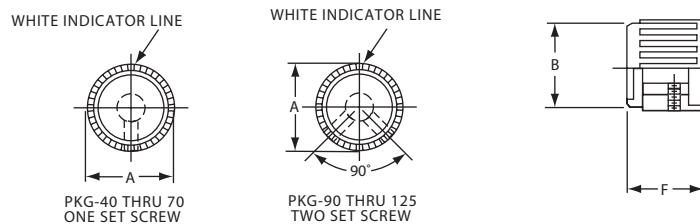

Product key	Dim A	Dim B	Dim F	Part Number
PKG40B1/8	11.1 (.437)	10.4 (.410)	12.0 (.472)	5-1437624-9
PKG50B1/8	14.0 (.551)	12.7 (.500)	13.0 (.512)	6-1437624-1
PKG50B1/4				6-1437624-0
PKG60B1/8	16.8 (.660)	15.6 (.615)	14.0 (.551)	6-1437624-6
PKG60B1/4				6-1437624-5
PKG70B1/8	18.8 (.740)	17.7 (.698)	14.2 (.559)	6-1437624-8
PKG70B1/4				6-1437624-7
PKG90B1/8	21.9 (.862)	20.6 (.811)	13.9 (.550)	7-1437624-0
PKG90B1/4				6-1437624-9
PKG100B1/4	26.8 (1.055)	25.5 (1.01)	14.1 (.555)	5-1437624-7
PKG125B1/4	31.7 (1.248)	30.4 (1.20)	14.4 (.565)	5-1437624-8

P Series, Molded Phenolic (Continued)

PKGP series

ribbed with bar pointers and indicator line



PKGP70B1/4

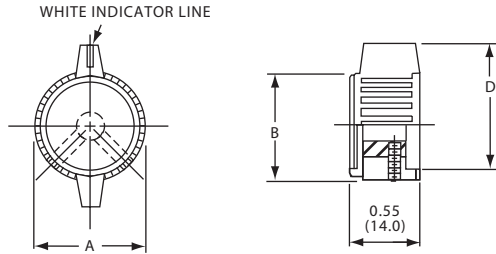

Product key	Dim A	Dim B	Dim D	Part Number
PKGP70B1/4	18.8 (.740)	17.8 (.700)	25.2 (.990)	7-1437624-2
PKGP90B1/4	21.8 (.860)	20.6 (.810)	32.5 (1.28)	7-1437624-3
PKGP100B1/4	26.2 (1.05)	25.4 (1.00)	41.2 (1.62)	7-1437624-1

PKJ series

straight knurl with bar pointers and indicator line



PKJ0B1/4

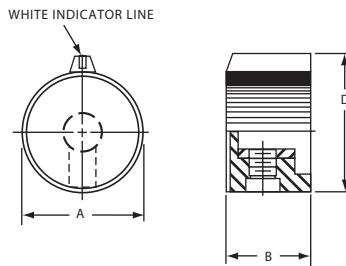

Product key	Dim A	Dim B	Dim D	Part Number
PKJ50B1/8	12.7 (.500)	13.0 (.512)	14.7 (.577)	7-1437624-5
PKJ50B1/4				7-1437624-4
PKJ60B1/4	16.0 (.630)	13.5 (.530)	19.3 (.758)	7-1437624-6
PKJ70B1/4	19.3 (.760)	14.1 (.555)	23.2 (.915)	7-1437624-7

PKJT series

straight knurl with bar pointer and indicator line, aluminum spin cap



PKJT70B1/4

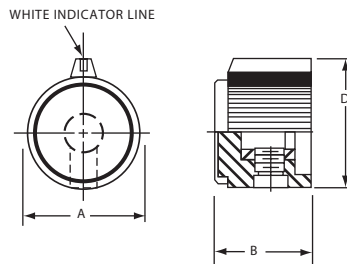

Product key	Dim A	Dim B	Dim D	Part Number
PKJT50B1/8	13.1 (.515)	14.9 (.585)	15.1 (.595)	7-1437624-9
PKJT50B1/4				7-1437624-8
PKJT60B1/4	16.3 (.640)	15.4 (.605)	19.3 (.760)	8-1437624-0
PKJT70B1/4	19.3 (.760)	15.9 (.625)	23.2 (.915)	8-1437624-1

P Series, Molded Phenolic (Continued)

PKN series

natural aluminum spin cap with line indicator



PKN60B1/8

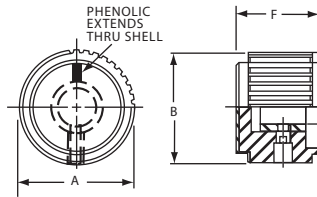

Product key	Dim A	Dim B	Dim F	Part Number
PKN60B1/8	15.0 (.591)	14.7 (.579)	11.5 (.453)	8-1437624-2
PKN60B1/4				1825009-1
PKN70B1/4	20.0 (.787)	19.4 (.764)	15.0 (.591)	8-1437624-3
PKN90B1/4	25.0 (.984)	24.3 (.957)	17.5 (.689)	8-1437624-4

PKNT series

black spin cap with "diamond cut", without indicator



PKNT60B1/4

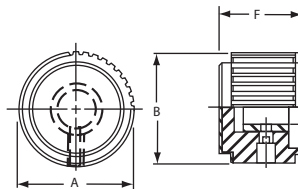

Product key	Dim A	Dim B	Dim F	Part Number
PKNT60B1/8	15.0 (.591)	14.7 (.579)	11.9 (.472)	8-1437624-6
PKNT60B1/4				8-1437624-5
PKNT70B1/4	19.9 (.787)	19.4 (.764)	14.7 (.591)	8-1437624-7
PKNT90B1/4	25.0 (.984)	24.3 (.957)	17.5 (.689)	8-1437624-8

PKS series

straight knurl with aluminum skirt and arrow or 1-10 numbers



PKS90B1/4

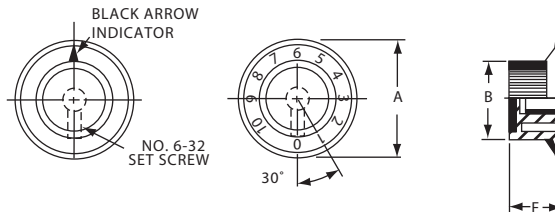

Product key	Marking	Dim A	Dim B	Dim F	Part Number
PKS90B1/4	arrow	36.1 (1.42)	23.3 (.917)	15.1 (.596)	1437625-5
PKS90B101/4	numbers				1437625-6

PKS series

straight knurl with indicator line on skirt



PKS1104B1/4

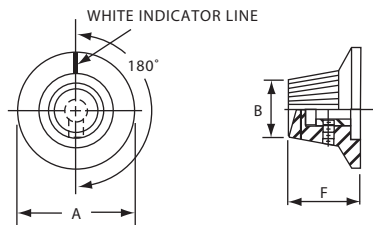

Product key	Dim A	Dim B	Dim F	Part Number
PKS1104B1/4	28.5 (1.12)	14.4 (.567)	17.0 (.670)	9-1437624-5

P Series, Molded Phenolic (Continued)

PKS series

straight knurl aluminum skirt with line or 0-9 numbers



PKS1106B1/4

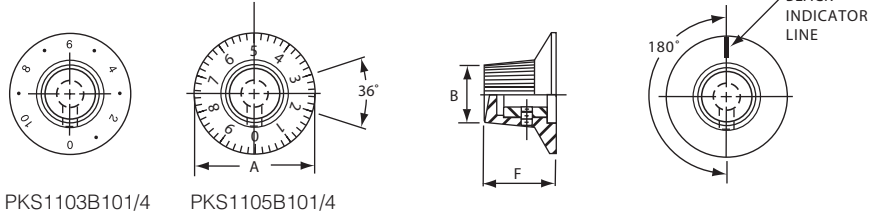

PKS1103B101/4

PKS1105B101/4

Product key	Marking	Dim A	Dim B	Dim F	Part Number
PKS1103B101/4	numbers	29.6 (1.17)	14.5 (.571)	17.0 (.670)	9-1437624-4
PKS1106B1/4	line				9-1437624-7
PKS1105B101/4	numbers				9-1437624-6

PKS series

straight knurl with 0-9, 0-10, -5+5 numerals



PKS1132B51/4

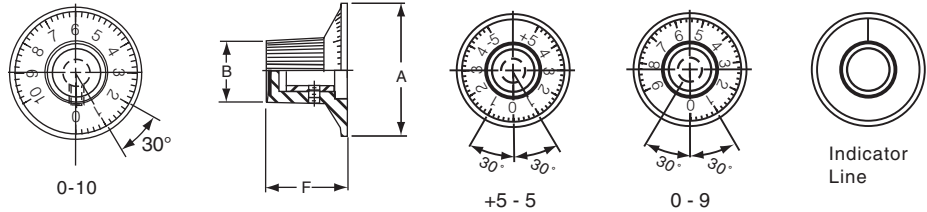

Product key	Marking	Dim A	Dim B	Dim F	Part Number
PKS1132B51/4	+5-0-5	30.0 (1.18)	14.0 (.551)	19.0 (.748)	1437625-1
PKS1132B91/4	0-9				1437625-2
PKS1132B101/4	0-10				9-1437624-9
*PKS1132B1/4	indicator line				9-1437624-8

*) Set screw 180° from indicator line.



PKS1132B91/4

PKX series

ribbed body, matte finish with square indicator on top



PKX50B1/8

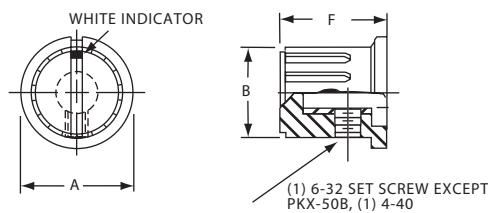

Product key	Dim A	Dim B	Dim F	Part Number
PKX50B1/8	15.0 (.590)	12.0 (.472)	14.0 (.551)	1-1437625-5
PKX50B1/4				1-1437625-4
PKX60B1/8	20.0 (.787)	15.9 (.625)	15.2 (.598)	1-1437625-7
PKX60B1/4				1-1437625-6

P Series, Molded Phenolic (Continued)

PKX series

ribbed body, matte finish with square indicator on top



PKX110B1/4

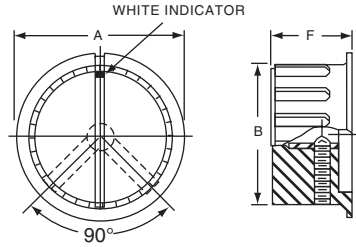

Product key	Dim A	Dim B	Dim F	Part Number
PKX100B1/4	29.7 (1.17)	24.6 (.970)	17.1 (.674)	1-1437625-1
PKX110B1/4	34.8 (1.37)	28.45 (1.120)	17.9 (.705)	1-1437625-2
PKX130B1/4	40.0 (1.57)	33.22 (1.308)	19.0 (.750)	1-1437625-3

Knob Accessories

Adaptors

KR

shaft hole size adaptors for aluminum and phenolic knobs



KR1

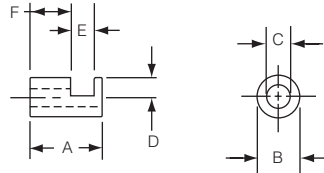

Prod. key	Version	Dim A	Dim B	Dim C	Dim D	Dim E	Dim F	Part Number
KR104	1/4" to 1/8"	9.50 (.374)	6.35 (.250)	3.25 (.128)	3.10 (.122)	5.51 (.217)	3.10 (.122)	1825620-1
KR204	1/4" to 3/16"	9.53 (.375)		4.83 (.190)		5.49 (.216)	3.12 (.123)	1825620-2
KR304	1/4" to 4mm		6.30 (.248)	4.09 (.161)				1825620-3

