



# PRODUCT SPECIFICATION

**SPEC. No:** \_\_\_\_\_

**Attn:** \_\_\_\_\_

**DATE: July.05.2012**

CUSTOMER PRODUCT NAME:
TDK PRODUCT NAME: <b>WT-1005660-12K2-A6-G</b>
THIS SPECIFICATION IS:

## **TDK-EPC Corporation**

### **Head Office Address:**

1-13-1, Nihonbashi, Chuo-ku, Tokyo  
103-0027, Japan

### **SALES**

MANAGER	SALES

### **ENGINEERING**

APPROVED	CHECKED	ISSUED

Sales Office \_\_\_\_\_

Sales Tel. \_\_\_\_\_

PRODUCT CLASSIFICATION CODE	
-----------------------------	--

# REVISED HISTORY

CUSTOMER PRODUCT NAME: \_\_\_\_\_

TDK PRODUCT NAME: **WT-1005660-12K2-A6-G**

NO.	REV.	REVISED CONTENT	REVISED REASON	DATE
1	0	To establish specification		2012.07.05

PRELIMINARY

# PRODUCT SPECIFICATION

TDK PRODUCT NAME:

**WT-1005660-12K2-A6-G**

SPEC. NO.

CUSTOMER PRODUCT NAME:

(1) Apperance & Dimensions (Unit: mm)

Weight: 46.7 g (Typ.)

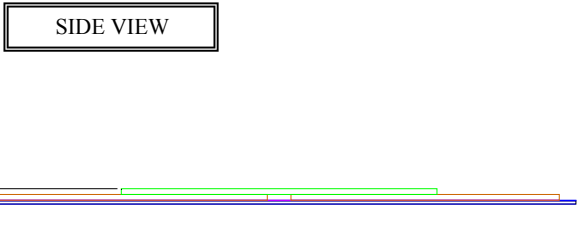
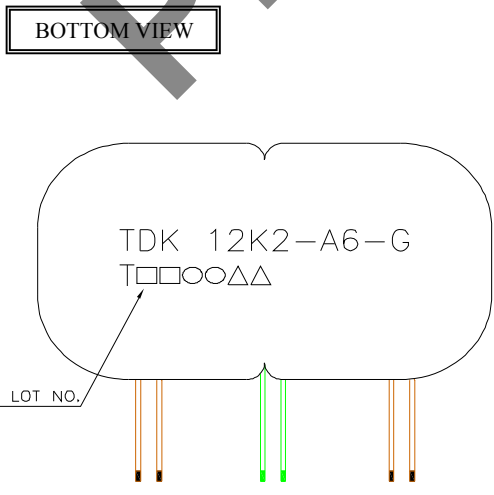
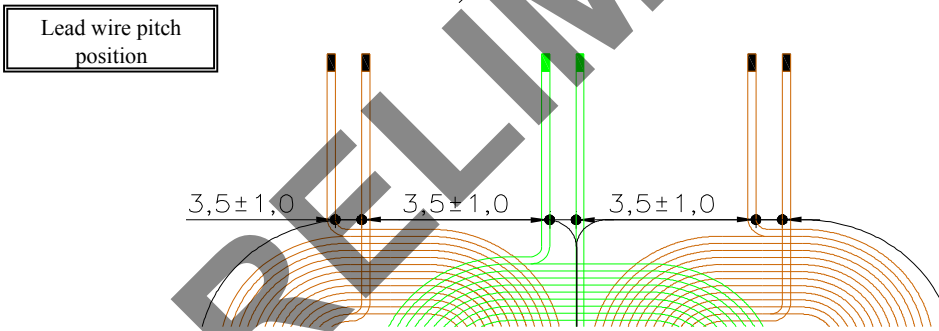
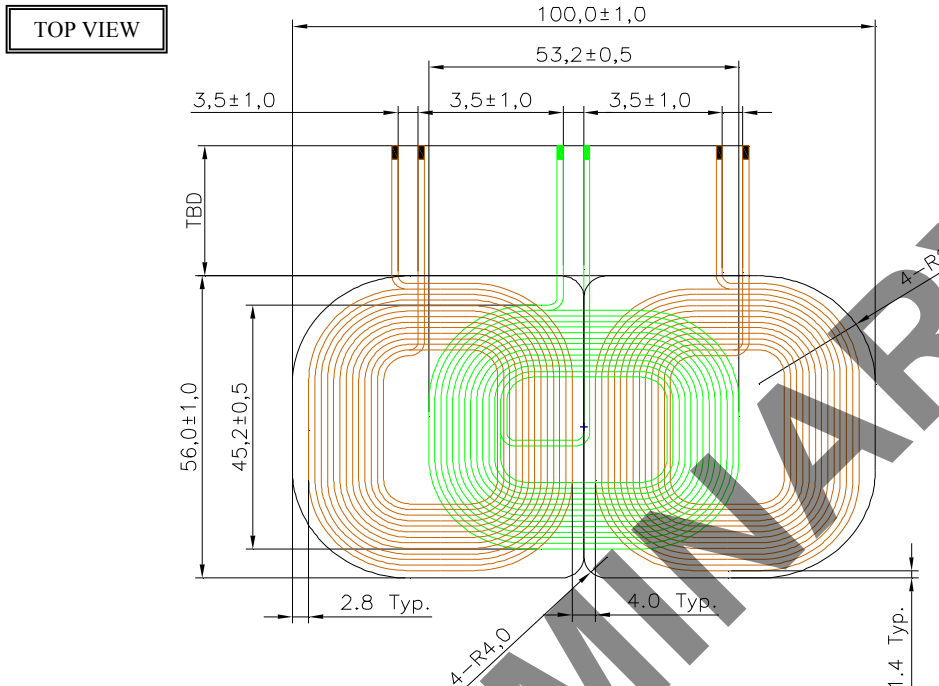

- [ Remarks ]
1. Lead wire pitch is end of wire position, not output terminal.
  2. Marking Content:
    - a. T: Manufacturing Centers
    - b. Lot No.: □ □ ○ ○ △ △
      - (1) (2) (3)
  - (1) Year: A.D. end number in double
  - (2) Month: Jan.(1), Feb.(02)...Dec.(12)
  - (3) Day: 01,02,03,...31.



# PRODUCT SPECIFICATION

TDK PRODUCT NAME: <b>WT-1005660-12K2-A6-G</b>	SPEC. NO.	CUSTOMER PRODUCT NAME:
--------------------------------------------------	-----------	------------------------

## (2) Air coil specification

Wire Diameter:  $\phi 0.08\text{mm} \times 105$  (Type2 Wire)

Coil Turns: 12TS / 1 layer

## (3) Electrical Characteristics

No.	Parameter	Specification	Test Instrument
1	Inductance	Coil 0	HP 4284A DIGITAL LCR METER or EQUIVALENT (@100kHz 1.0 Vrms)
		Coil 1	
		Coil 2	
2	Q Value	Coil 0	HP 4284A DIGITAL LCR METER or EQUIVALENT (@100kHz 1.0 Vrms)
		Coil 1	
		Coil 2	
3	DC Resistance	Coil 0	CHEN HWA 502A OHM METER or EQUIVALENT
		Coil 1	
		Coil 2	

\* Remark:

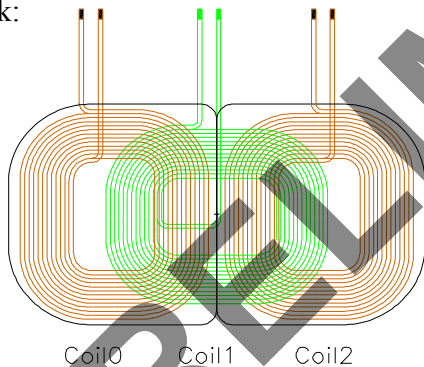

## (4) Temperature Characteristics

No.	Parameter	Specification
1	Operating Temperature	-30~70°C
2	Storage Temperature	-40~85°C

## (5) Application

1. The product fit in with RoHS rule.
2. The product fit in with Halogen-Free.
3. Reflow and dip-flow soldering can not used for this product.

# PRODUCT SPECIFICATION

TDK PRODUCT NAME: <b>WT-1005660-12K2-A6-G</b>	SPEC. NO.	CUSTOMER PRODUCT NAME:
--------------------------------------------------	-----------	------------------------

## (6) Reliability Conditions

No.	Parameter	Conditions
1	Low Temperature (Storage)	(1) Temperature : $-40\pm 2^{\circ}\text{C}$ (2) Time : 240Hrs
2	High Temperature (Storage)	(1) Temperature : $+85\pm 2^{\circ}\text{C}$ (2) Time : 240Hrs
3	Thermal Shock	(1) Temperature : $-40\pm 5^{\circ}\text{C} / 30\text{min} \sim +85\pm 5^{\circ}\text{C} / 30\text{min}$ (2) Ambient Time : 5min (3) Times : 100cycles
4	Vibration	Unpacked: (1) frequency: 10~500Hz sweep 1 octave wave / 1 min (2) Amplitude: 1.5mm (p-p) or 10G (3) Direction: X, Y, Z, direction (4) Time: X, Y, Z for 2 hours each.
5	Temperature / Humidity (Storage)	(1) Temperature : $+60\pm 2^{\circ}\text{C}$ (2) Humidity: 90% RH. (3) Time: 240Hrs
6	Temperature / Humidity (OP)	(1) Temperature : $+60\pm 2^{\circ}\text{C}$ (2) Humidity: 90% RH. (3) Time: 240Hrs (4) Current: DC 1.0A (5) Frequency: 100kHz
7	Package Drop	(1) Drop the sample package in a carton box. (2) Height : 100 cm (3) Direction : 1 corner, 3 edges, 6 faces (4) Drop time : 16 times
8	ESD(HBM)	(1) Test Voltage: 1000V (2) Ambient: $25\pm 5^{\circ}\text{C}$ (3) Time: Negative / Positive each 1 time (4) Resistance: 1500 $\Omega$ (5) Capacitance: 100pF
9	ESD(MM)	(1) Test Voltage: 100V (2) Ambient: $25\pm 5^{\circ}\text{C}$ (3) Time: Negative / Positive each 1 time (4) Capacitance: 200pF

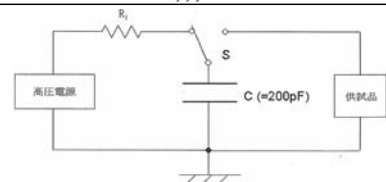
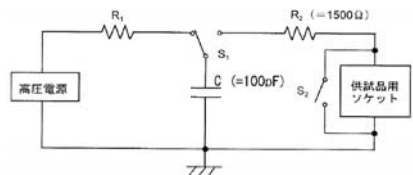

# PRODUCT SPECIFICATION

TDK PRODUCT NAME: <b>WT-1005660-12K2-A6-G</b>	SPEC. NO.	CUSTOMER PRODUCT NAME:
--------------------------------------------------	-----------	------------------------

(7) Construction

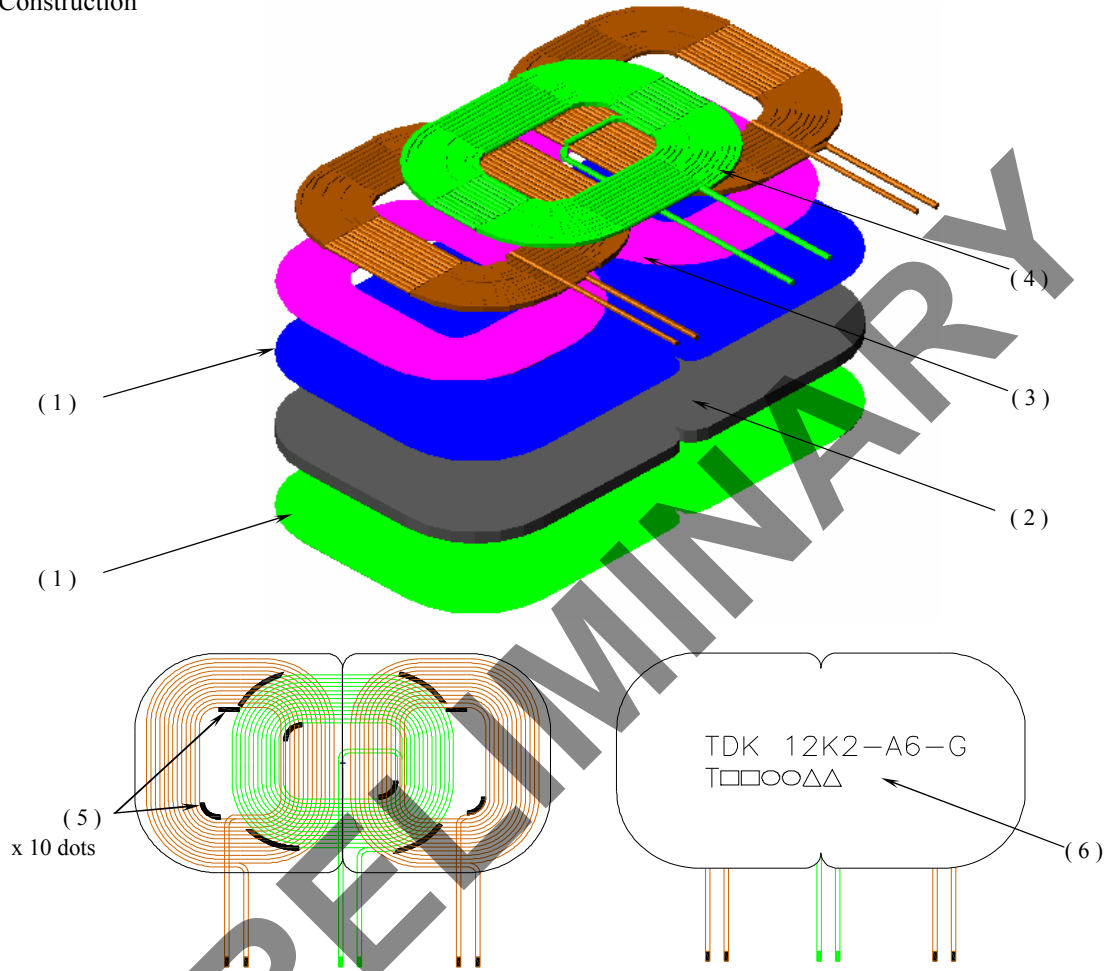

(8) Material List

No.	Material Name
1	PET Tape
2	Ferrite Sheet
3	Adhesive Tape
4	Air Coil
5	Glue
6	Ink

# PRODUCT SPECIFICATION

TDK PRODUCT NAME:

**WT-1005660-12K2-A6-G**

SPEC. NO.

CUSTOMER PRODUCT NAME:

## (9) Packing

1. To stack the the Trays onto 4 Layers:

- PET tray dimension: 326\*329\*11.0mm (REF.)

- 6 Pcs / per PET tray (REF.)

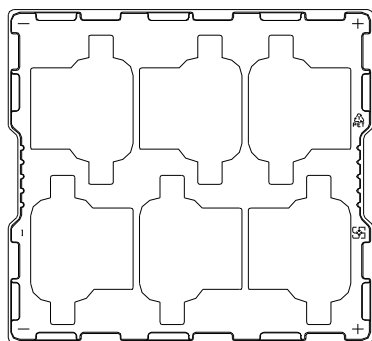

Total : 2x3=6pcs

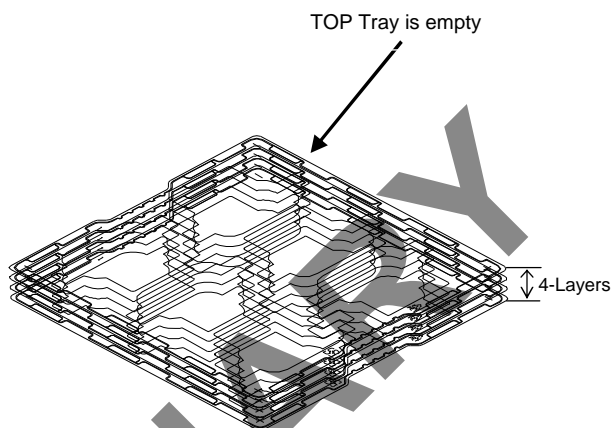

Total : 6x3=18pcs

2. To put 2 Trays of products into the small Carton and affixing the out-going label on the outside .

- Small carton dimension: 331\*337\*33mm (REF.)

- 4 PET Trays / per small carton ( PET tray of the top side is empty in the small carton)

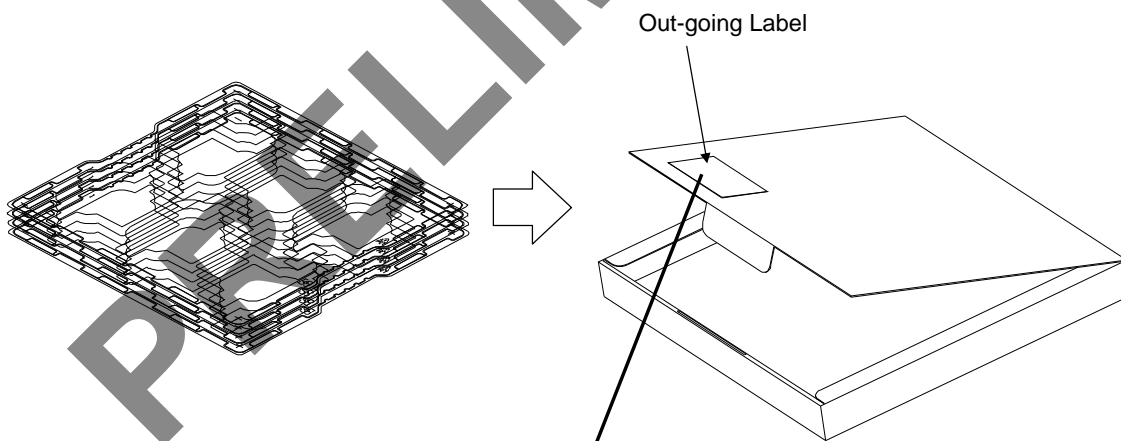

CUST PROD ID(P): 123456789.		Customer	<b>SAMPLE</b>
QTY(Q): 72		ROHS	
(6P):TTXDF12345TWN273711000			
TDK ITEM(IP): WT-1005660-12K2-A6-G	VDR(V):TDK		
LOT NO(IT): WL12K34567+M0001	DATE CODE(T): 1411	0001	
2011/11/22	MADE IN TAIWAN	12325A0435	
(ITEM: WT-1005660-12K2-A6-G)	M/TTXDF12345	TDK	(S)
TDK TAIWAN CORPORATION			

Out-going Label

# PRODUCT SPECIFICATION

TDK PRODUCT NAME:

**WT-1005660-12K2-A6-G**

SPEC. NO.

CUSTOMER PRODUCT NAME:

3. To put 3 small carton into the Carton .

- Outer carton dimension: 347\*340\*124mm (REF.)
- 3 small cartons / per outer carton
- Total quantity : 54 Pcs (REF.)

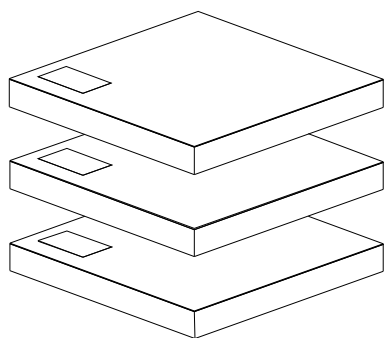

3 small cartons

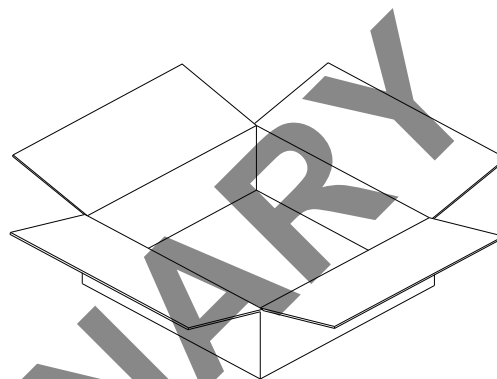

Outer carton

4. Packing.

- To pack the carton by scotch tape and affix out-going label (outside) on it outside.
- The Inspection data in the box , there would be a signet mark on it outside.

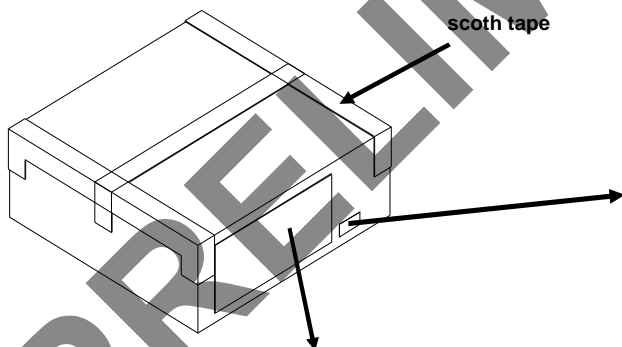

scotch tape

INSPECTION DATA  
ENCLOSED  
檢驗紀錄表在內

signet mark of Inspection data

(3S) TTTW-WL11K0600200101400000360		CUSTOMER: Customer	
		CUST. PART NO(P): 12A34567-89A	
(6S) C/NO:1	BOX COUNT		
	001/009	TDK ITEM CODE(6P): 1TXDF12345TWN	
SHIPPING MARK		ROHS	
<b>SAMPLE</b>		P/O NO.(K): TTTT-S123456789	
		LOT NO.(IT): WL12345678	DATE: Nov.22.2011
		QTY(Q): 288	
Customer		TDK ITEM (IP): WT-1005660-12K2-A6-G	
Location			
MADE IN TAIWAN		(WT-1005660-12K2-A6-G)	
WL12K34567		SUB P/O NO.(6K): 4500059424	
12345A6789			
		TDK SPEC.	
C/NO : 1	WAREHOUSE	TDK TAIWAN CORPORATION	
	NW 3.6 GW 4.0	YANGMEI, TAIWAN	
		9	
		TTXDF10105	

out-going label