

San Ace 38

Low Power Consumption Fan

Features

Low Power Consumption

Power consumption is reduced by approx. 22% compared with our conventional product*.

High Static Pressure

Maximum static pressure is increased by approx. 1.9times compared with our conventional product*.

*: Specification of Model No.9GA0312P3K001.
Our conventional product is 38 x 38 x 28 mm "San Ace 38", Model No.9GV0312P3K01.



Low Power Consumption Fan 38mm

38x38x28mm GA type

Specifications

Model No.	Rated Voltage [V]	Operating Voltage Range [V]	PWM Duty Cycle [%] ^{Note1}	Rated Current [A]	Rated Input [W]	Rated Speed [min ⁻¹]	Max. Air Flow [m ³ /min] [CFM]	Max. Static Pressure [Pa] [inchH ₂ O]	SPL [dB(A)]	Operating Temperature [°C]	Expected Life [h] ^{Note2}
9GA0312P3K001(0011)	12	10.8 to 13.2	100	0.62	7.4	25,000	0.60 21.2	800 3.21	59.0	-10 to +70	40,000/60°C (70,000/40°C)
			0	0.06	0.7	3,000	0.07 2.5	11 0.04	15.0		
9GA0312P3J001(0011)			100	0.52	6.2	23,500	0.57 20.1	720 2.89	57.5		
			0	0.06	0.7	3,000	0.07 2.5	11 0.04	15.0		
9GA0312P3G001(0011)			100	0.33	4.0	19,000	0.45 15.9	460 1.85	53.0		
			0	0.06	0.7	3,000	0.07 2.5	11 0.04	15.0		

The numbers in () represent ribless models.

Note1 : PWM Frequency : 25kHz

Note2 : Expected life at 40°C ambient is just reference value.

Common Specifications

- Material Frame, Impeller : Plastics (Flammability: UL94V-0)
- Expected Life Varies for each model
(L10: Survival rate: 90% at 60°C, rated voltage, and continuously run in a free air state)
- Motor Protection System Current blocking function and Reverse polarity protection
- Dielectric Strength 50/60 Hz, 500VAC, 1 minute (between lead conductor and frame)
- Sound Pressure Level (SPL) Expressed as the value at 1m from air inlet side
- Operating Temperature Varies for each model (Non-condensing)
- Storage Temperature -30°C to +70°C (Non-Condensing)
- Lead Wire ⊕Red ⊖Black Sensor: Yellow Control: Brown
- Mass Approx. 52g

38mm

Air Flow - Static Pressure Characteristics

- PWM Duty Cycle

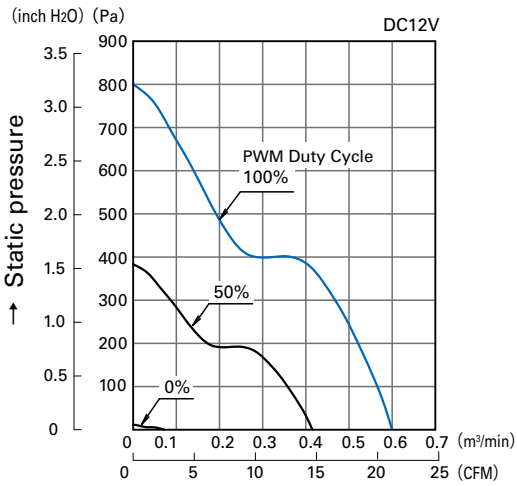

→ Air flow
9GA0312P3K001(0011)

- Operating Voltage Range

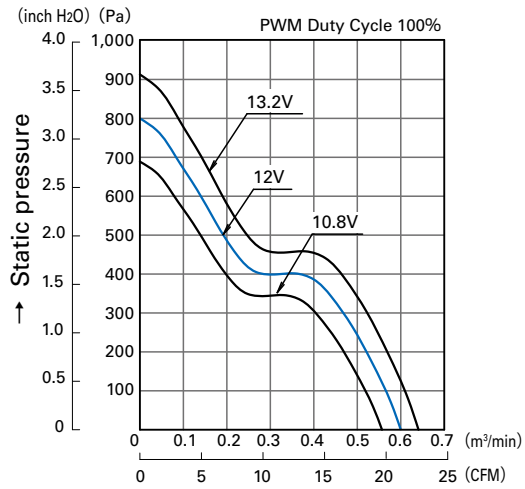

→ Air flow
9GA0312P3K001(0011)

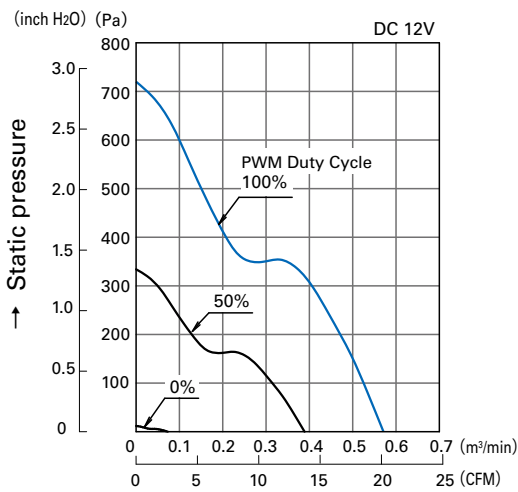

→ Air flow
9GA0312P3J001(0011)

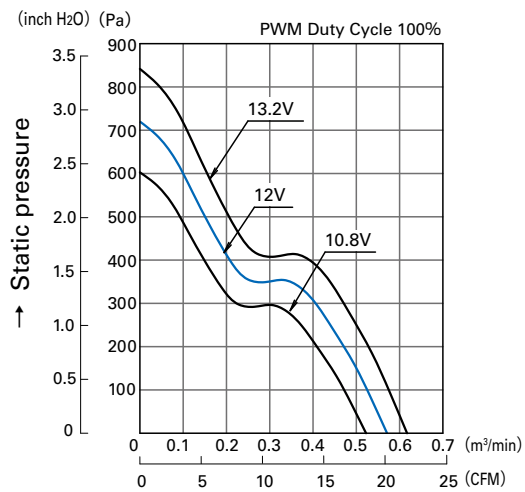

→ Air flow
9GA0312P3J001(0011)

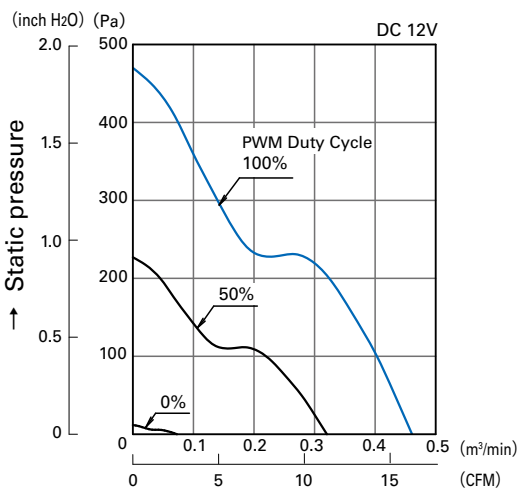

→ Air flow
9GA0312P3G001(0011)

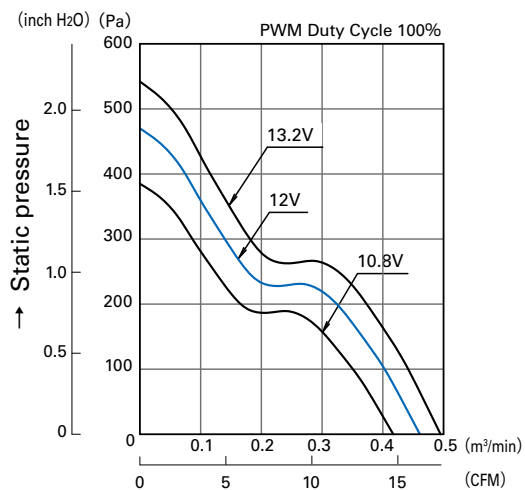

→ Air flow
9GA0312P3G001(0011)

PWM Duty - Speed Characteristics Example

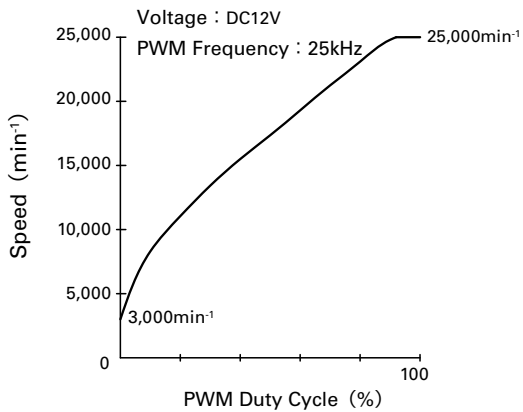

9GA0312P3K001(0011)

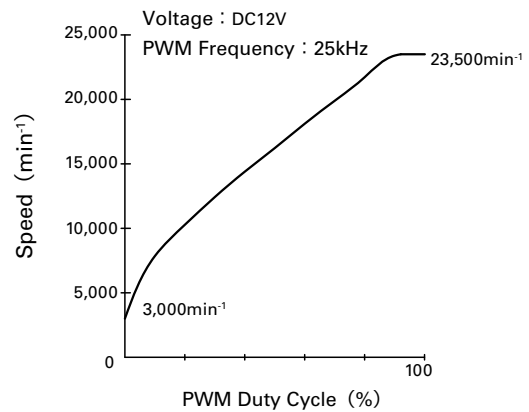

9GA0312P3J001(0011)

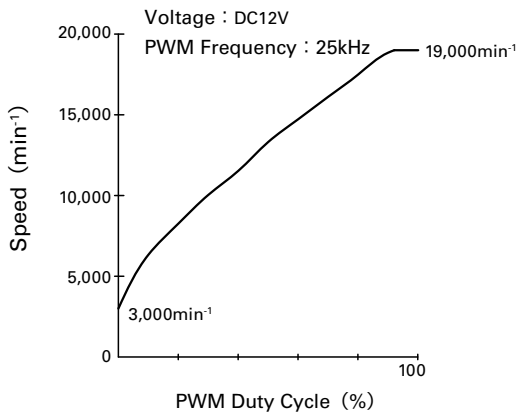

9GA0312P3G001(0011)

PWM Input Signal Example

Input Signal Wave Form

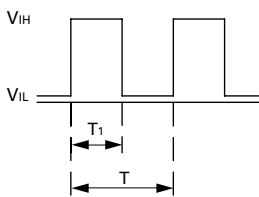

$V_{IH}=2.8V$ to $3.8V$
 $V_{IL}=0V$ to $0.4V$
 PWM Duty Cycle (%) = $\frac{T1}{T} \times 100$
 PWM Frequency 25 (kHz) = $\frac{1}{T}$
 Source Current : 1mA Max. at control voltage 0V
 Sink Current : 1mA Max. at control voltage 3.8V
 Control Terminal Voltage : 3.8V Max. (Open Circuit)
 When the control lead wire is open,
 the fan speed is the same as the one at a PWM duty cycle of 100%.
 Either TTL input, open collector or open drain can be used for
 PWM control input signal.

Connection Schematic

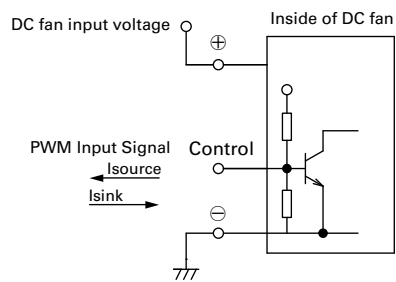

Pulse Sensor Specification

Output circuit : Open collector

$V_{CE} = +13.8V$ MAX.
 $I_c = 5mA$ MAX. [$V_{OL} = V_{CE} (SAT) = 0.6V$ MAX.]

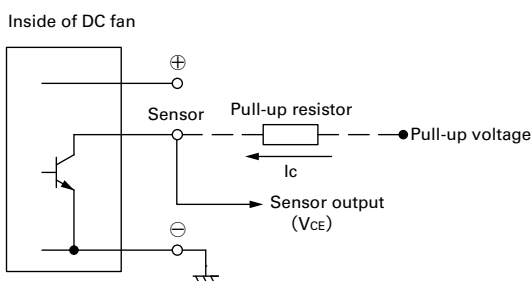

Output waveform (Need pull-up resistor)

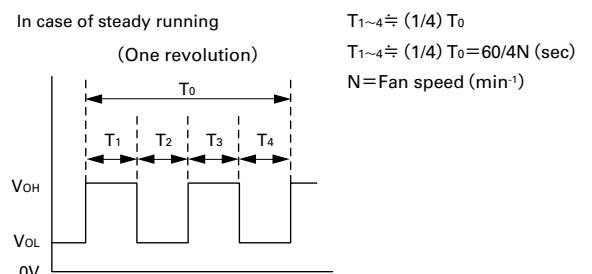

Dimensions (unit : mm) (with ribs)

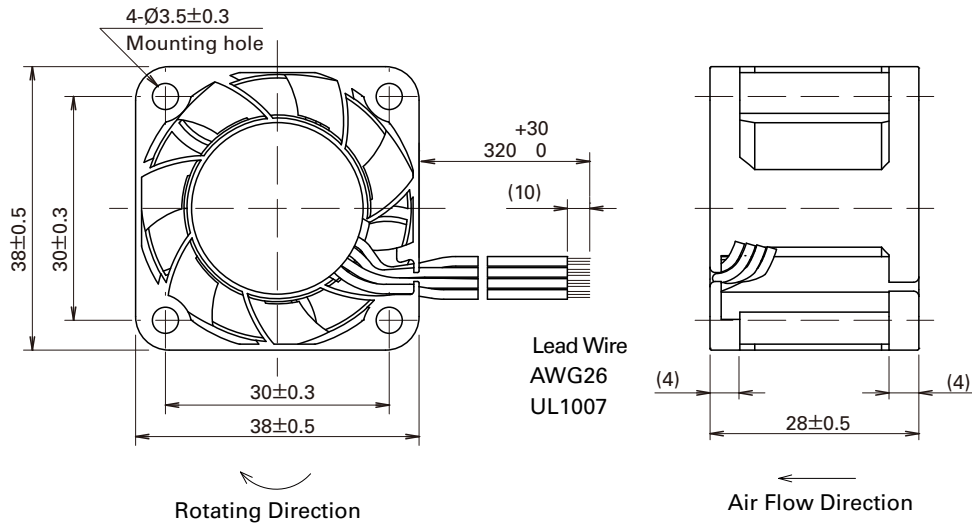

Reference dimension of mounting holes and vent opening (unit : mm)

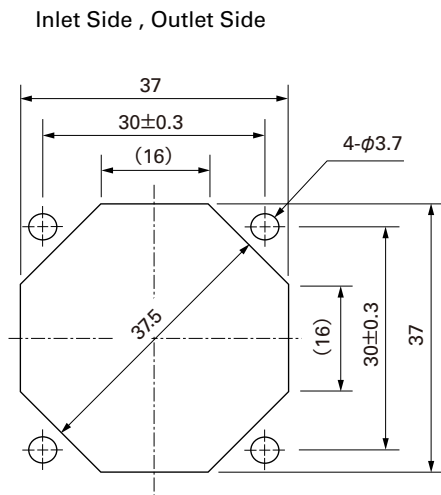

Notice

- The products shown in the catalog are subject to Japanese Export Control Law. Diversion contrary to the law of exporting country is prohibited.
- To protect against electrolytic corrosion that may occur in locations with strong electromagnetic noise, we provide fans that are unaffected by electrolytic corrosion.

SANYO DENKI CO.,LTD. 1-15-1, Kita-otsuka, Toshima-ku,Tokyo 170-8451, Japan. PHONE :+ 81 3 3917 5151

<http://www.sanyodenki.com>

The names of companies and/or their products specified in this catalog are the trade names, and/or trademarks and/or registered trademarks of such respective companies. "San Ace" is a trademark of SANYO DENKI CO.,LTD.

Specifications are subject to change without notice.

CATALOG NO. C1016B001 '12.10