

LUXEON M

High Flux Density and Efficacy

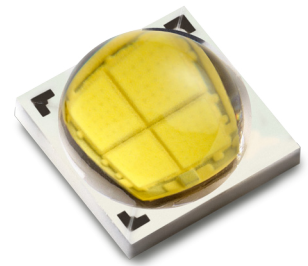

Introduction

LUXEON® M emitters are illumination grade LEDs designed to enable indoor, outdoor and industrial applications which are optimized either for high efficiency or low cost. With Freedom From Binning and leading performance, LUXEON M emitters deliver high efficacy and high flux density from a uniform source with tight correlated color temperature control.

Features and Benefits

- Uniform image enabling tight beam control in MR-16 and spot lighting applications
- Specified, targeted and tested hot, at real world operating temperatures: $T_j = 85^\circ\text{C}$ to ensure *in application* performance
- High Flux Density with over 1200 “hot” lumens available from a 3x3 mm LED area enables reduced emitter counts and compact fixture designs
- Uniform intensity and color across source with 70, 80 and 90 CRI minimum
- *Freedom from Binning* delivers color consistency within a single 3 or 5-step MacAdam ellipse
- 11.2V and 5.6V packages put high performance within reach with high efficiency and low cost drivers
- Exceeds ENERGY STAR® lumen maintenance requirements.

Key Applications

- Outdoor
- High bay and low bay
- Downlights
- Lamps
- Indoor area lighting
- Spotlights

Table of Contents

General Information	2
Product Nomenclature	2
Average Lumen Maintenance Characteristics	3
Environmental Compliance	3
Product Selection	4
Optical and Electrical Characteristics	6
Absolute Maximum Ratings	7
JEDEC Moisture Sensitivity	7
Reflow Soldering Characteristics	8
Mechanical Dimensions	9
Pad Configuration	9
Solder Pad Design	10
Relative Spectral Distribution vs. Wavelength Characteristics	11
Typical Light Output Characteristics	13
Typical Light Output Characteristics	14
Forward Current Characteristics	15
Typical Radiation Patterns	16
Emitter Pocket Tape Packaging	17
Emitter Reel Packaging	18
Product Binning and Labeling	19
Luminous Flux Bins	20
Radiometric Power Bins	20
LUXEON M Color Bin Definition	21

General Information

Product Nomenclature

LUXEON M emitters are specified and binned “hot” under conditions comparable to those found in “real-world” lighting products.

The part number designation is explained as follows:

L X R a - b c d e - f g h j

Where:

a — designates minimum CRI (7 = 70, 8 = 80, 9 = 90, 0 = Royal Blue)

b — is S for serially connected product with voltage less than 12V; R for series-parallel collected product with voltage less than 6V.

c — designates color designation (W = White, R = Royal Blue)

d, e — designates CCT (27 = 2700K, 30 = 3000K, 35 = 3500K, 40 = 4000K, 50 = 5000K, 57 = 5700K, 00 = Royal Blue)

fghj — minimum flux lumen (optional)

The test conditions for 12V LUXEON M LXRa-Scde-fghj are 700mA DC with junction temperature 85C. The test condition for 6V LUXEON M LXRa-Rcde-fghj are 1400mA DC with junction temperature 85C.

Therefore LUXEON M 12V products tested and binned at 700 mA follow the part numbering scheme:

L X R 7 - S W 3 0 - x x x x

L X R 7 - S W 4 0 - x x x x

L X R 7 - S W 5 0 - x x x x

L X R 7 - S W 5 7 - x x x x

L X R 7 - S W 6 5 - x x x x

L X R 8 - S W 2 7 - x x x x

L X R 8 - S W 3 0 - x x x x

L X R 8 - S W 3 5 - x x x x

L X R 8 - S W 4 0 - x x x x

L X R 8 - S W 5 0 - x x x x

L X R 9 - S W 2 7 - x x x x

L X R 9 - S W 3 0 - x x x x

L X R 0 - S R 0 0 - x x x x

LUXEON M 6V products tested and binned at 1400 mA follow the part numbering scheme:

LXR7 - RW30 - xxxx

LXR7 - RW40 - xxxx

LXR7 - RW50 - xxxx

LXR7 - RW57 - xxxx

LXR7 - RW65 - xxxx

LXR8 - RW27 - xxxx

LXR8 - RW30 - xxxx

LXR8 - RW35 - xxxx

LXR8 - RW40 - xxxx

LXR8 - RW50 - xxxx

LXR9 - RW27 - xxxx

LXR9 - RW30 - xxxx

LXR0 - RR00 - xxxx

Average Lumen Maintenance Characteristics

Lumen maintenance for solid-state lighting devices (LEDs) is typically defined in terms of the percentage of initial light output remaining after a specified period of time. Philips Lumileds projects that LUXEON M products will deliver, on average, 70% lumen maintenance (L70) at 50,000 hours of operation at a forward current of up to 700 mA for LXR_x-S_{xxxx} and 1400 mA for LXR_x-R_{xxxx}. This projection is based on constant current operation with junction temperature maintained at or below 135°C. This performance is based on Philips Lumileds historical data from tests run on similar material systems, and internal LM80 and reliability testing. Observation of design limits included in this data sheet is required in order to achieve this projected lumen maintenance.

Environmental Compliance

Philips Lumileds is committed to providing environmentally friendly products to the solid-state lighting market. LUXEON M is compliant to the European Union directives on the restriction of hazardous substances in electronic equipment, namely the RoHS directive. Philips Lumileds will not intentionally add the following restricted materials to the LUXEON M lead, mercury, cadmium, hexavalent chromium, polybrominated biphenyls (PBB) or polybrominated diphenyl ethers (PBDE).

Product Selection

Product Selection Guide for LUXEON M I2V White Junction Temperature = 85°C

Table 1.

Performance at Test Current				
Nominal CCT	Part Number	Minimum CRI	Minimum Luminous Flux (lm)	Typical Luminous Flux (lm)
3000K	LXR7-SW30	70	840	905
4000K	LXR7-SW40	70	900	980
5000K	LXR7-SW50	70	900	980
5700K	LXR7-SW57	70	900	1000
6500K	LXR7-SW65	70	900	1000
2700K	LXR8-SW27	80	680	760
3000K	LXR8-SW30	80	710	800
3500K	LXR8-SW35	80	745	860
4000K	LXR8-SW40	80	780	905
5000K	LXR8-SW50	80	800	905
2700K	LXR9-SW27	90	570	610
3000K	LXR9-SW30	90	580	620

Notes for Table 1:

1. Philips Lumileds maintains a tolerance of $\pm 6.5\%$ on flux measurements.
2. Test current is 700 mA for all LXR x -SW xx products.

Product Selection Guide for LUXEON M I2V Royal Blue Junction Temperature = 85°C

Table 2.

Performance at Test Current				
Color	Part Number	Minimum Radiometric Power (mW)	Typical Radiometric Power (mW)	Typical Radiant Efficacy (%)
Royal Blue	LXR0-SR00	4000	4200	53.6

Note for Table 2:

1. Philips Lumileds maintains a tolerance of $\pm 6.5\%$ on flux measurements.
2. Test current is 700 mA for LXR0-SR00 products.

Product Selection Guide for LUXEON M 6V White

Junction Temperature = 85°C

Table 3.

Performance at Test Current				
Nominal CCT	Part Number	Minimum CRI	Minimum Luminous Flux (lm)	Typical Luminous Flux (lm)
3000K	LXR7-RW30	70	840	905
4000K	LXR7-RW40	70	900	980
5000K	LXR7-RW50	70	900	980
5700K	LXR7-RW57	70	900	1000
6500K	LXR7-RW65	70	900	1000
2700K	LXR8-RW27	80	680	760
3000K	LXR8-RW30	80	710	800
3500K	LXR8-RW35	80	745	860
4000K	LXR8-RW40	80	780	905
5000K	LXR8-RW50	80	800	905
2700K	LXR9-RW27	90	570	610
3000K	LXR9-RW30	90	580	620

Notes for Table 3:

1. Philips Lumileds maintains a tolerance of $\pm 6.5\%$ on flux measurements.
2. Test current is 1400 mA for all LXR_x-RW_{xx} products.

Product Selection Guide for LUXEON M 6V Royal Blue

Junction Temperature = 85°C

Table 4.

Performance at Test Current				
Color	Part Number	Minimum Radiometric Power (mW)	Typical Radiometric Power (mW)	Typical Radiant Efficacy (%)
Royal Blue	LXR0-RR00	4000	4200	53.6

Note for Table 4:

1. Philips Lumileds maintains a tolerance of $\pm 6.5\%$ on flux measurements.
2. Test current is 1400 mA for LXR0-RR00 products.

Optical and Electrical Characteristics

LUXEON M White at Test Current ^[1], Junction Temperature = 85°C

Table 5.

Nominal CCT (K)	Part Number	Color Temperature CCT Typical (K) ^[2]	Typ Total Included Angle ^[2] (degrees) $\theta_{0.90V}$	Typ Viewing Angle ^[3] (degrees) $2\theta_{1/2}$
2700	LXR8-SW27, LXR8-RW27	2725	140	120
	LXR9-SW27, LXR9-RW27	2725	140	120
3000	LXR7-SW30, LXR7-RW30	3045	140	120
	LXR8-SW30, LXR8-RW30	3045	140	120
	LXR9-SW30, LXR9-RW30	3045	140	120
3500	LXR8-SW35, LXR8-RW35	3465	140	120
4000	LXR7-SW40, LXR7-RW40	3985	140	120
	LXR8-SW40, LXR8-RW40	3985	140	120
5000	LXR7-SW50, LXR7-RW50	5028	140	120
	LXR8-SW50, LXR8-RW50	5028	140	120
5700	LXR7-SW57, LXR7-RW57	5665	140	120
6500	LXR7-SW65, LXR7-RW65	6530	140	120

Notes for Table 5:

1. Test current is 700 mA for LXR_x-SW_{xx} and 1400 mA for LXR_x-RW_{xx} products.
2. Total included angle at which 90% of total luminous flux is captured.
3. Viewing angle is the off axis angle from lamp centerline where the luminous intensity is 1/2 of the peak value.

LUXEON M Royal Blue at Test Current ^[1], Junction Temperature = 85°C

Table 6.

Color	Peak Wavelength, λ_p ^[2]			Typical Spectral Half-width (nm) ^[3] $\Delta\lambda_{1/2}$	Typ. Temperature Coefficient of Peak Wavelength (nm/°C) $\Delta\lambda_D / \Delta T_J$	Typ. Total Included Angle (degrees) ^[4] θ_{90V}	Typical Viewing Angle (degrees) ^[5] $2\theta_{1/2}$
	Minimum	Typical	Maximum				
Royal Blue	445.0 nm	447.5nm	460.0nm	22	0.05	140	150

Notes for Table 6:

1. Test current is 700 mA for LXR0-SR00 and 1400 mA for LXR0-RR00.
2. Royal Blue product is binned by radiometric power and peak wavelength rather than photometric lumens.
3. Spectral half-width is 1/2 of the peak intensity.
4. Total included angle at which 90% of total radiometric power is captured.
5. Viewing angle is the off axis angle from lamp centerline where the luminous intensity is 1/2 of the peak value.

Electrical Characteristics for LUXEON M at Test Current ^[1], Junction Temperature = 85°C for all CCTs and Royal Blue

Table 7.

Part Number	Forward Voltage V_f ^[1,2] (V) $I_f = 700 \text{ mA}$			Typical Temperature Coefficient of Forward Voltage ^[3] (mV/°C) $\Delta V_f / \Delta T_j$	Typical Thermal Resistance Junction to Thermal Pad (°C/W) $R_{\theta_{j-c}}$
	Minimum	Typical	Maximum		
LXRx-Sxxx	10.5	11.2	12	-5.5	1.25
LXRx-Rxxx	5.44	5.6	5.72	-5.5	1.25

Notes for Table 7:

1. Test current is 700 mA for LXRx-Sxxx and 1400 mA for LXRx-Rxxx products.
2. Philips Lumileds maintains a tolerance of $\pm 0.5\%$ on forward voltage measurements.
3. Measured between $T_j = 25^\circ\text{C}$ and $T_j = 135^\circ\text{C}$.

Absolute Maximum Ratings

Table 8.

Parameter	Maximum Performance
DC Forward Current (mA) ^[1,2]	1050 mA for LXRx-Sxxx; 2100 mA for LXRx-Rxxx
Peak Pulsed Forward Current ^[1,3]	1200 mA for LXRx-Sxxx; 2400 mA for LXRx-Rxxx
ESD Sensitivity	$\leq 8000\text{V}$ Human Body Model (HBM) Class 3B JESD22-A114-E < 400V Machine Model (MM) Class B JESD22-A115-B
LED Junction Temperature ^[1]	135°C
Operating Case Temperature at Current	-40°C - 120°C @ 700 mA for LXRx-Sxxx -40°C - 120°C @ 1400 mA for LXRx-Rxxx
Storage Temperature	-40°C - 120°C
Lead Soldering Temperature	JEDEC 020c 260°C
Allowable Reflow Cycles	3
Autoclave Conditions	121°C at 2 ATM 100% Relative Humidity for 96 Hours Maximum
Reverse Voltage (V_r)	LUXEON M LEDs are not designed to be driven in reverse bias

Notes for Table 8:

1. Proper current derating must be observed to maintain junction temperature below the maximum.
2. Residual periodic variations due to power conversion from alternating current (AC) to direct current (DC), also called "ripple", with frequencies $\geq 100\text{Hz}$ and amplitude $\leq 1200 \text{ mA}$ for LXRx-Sxxx and amplitude $\leq 2400 \text{ mA}$ for LXRx-Rxxx are acceptable, assuming the average current throughout each cycle does not exceed 1050 mA for LXRx-Sxxx and 2100 mA for LXRx-Rxxx.
3. Pulsed operation with a peak drive current of 1200 mA for LXRx-Sxxx and peak drive current of 2400 mA for LXRx-Rxxx is acceptable if the pulse on time is $\leq 5\text{ms}$ per cycle and the duty cycle is $\leq 50\%$.

JEDEC Moisture Sensitivity

Table 9.

Level	Soak Requirements			
	Floor Life		Standard	
	Time	Conditions	Time	Conditions
I	Unlimited	$\leq 30^\circ\text{C} / 85\% \text{ RH}$	168 Hrs. + 5 / -0 Hrs.	85°C / 85% RH

Reflow Soldering Characteristics

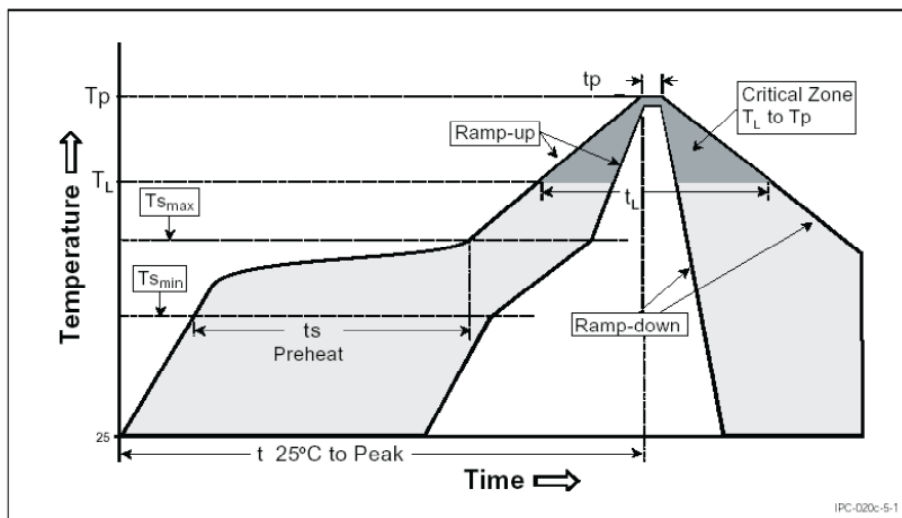

Temperature Profile for Table 8.

Table 10.

Profile Feature	Lead Free Assembly
Average Ramp-Up Rate (T_{s_max} to T_p)	3°C / second max
Preheat Temperature Min (T_{s_min})	150°C
Preheat Temperature Max (T_{s_max})	200°C
Preheat Time (t_{s_min} to t_{s_max})	60 - 180 seconds
Time Maintained Above Temperature T_L	217°C
Time Maintained Above Time (t_L)	60 - 150 seconds
Peak / Classification Temperature (T_p)	260°C
Time Within 5°C of Actual Peak Temperature (t_p)	20 - 40 seconds
Ramp-Down Rate	6°C / second max
Time 25°C to Peak Temperature	8 minutes max

Note for Table 10:

I. All temperatures refer to the application Printed Circuit Board (PCB), measured on the surface adjacent to the package body.

Mechanical Dimensions

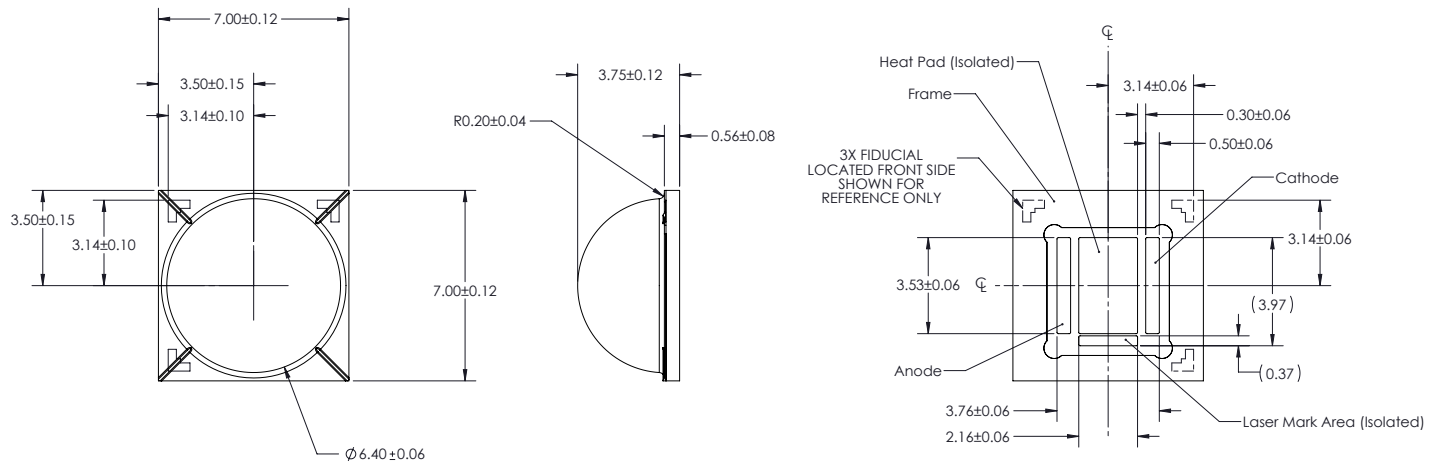

Figure 2. Package outline drawing.

Notes for Figure 2:

1. Do not handle the device by the lens. Excessive force on the lens may damage the lens itself or the interior of the device.
2. All dimensions are in millimeters.
3. Drawings not to scale.
4. The thermal pad is electrically isolated from the anode and cathode contact pads.

Pad Configuration

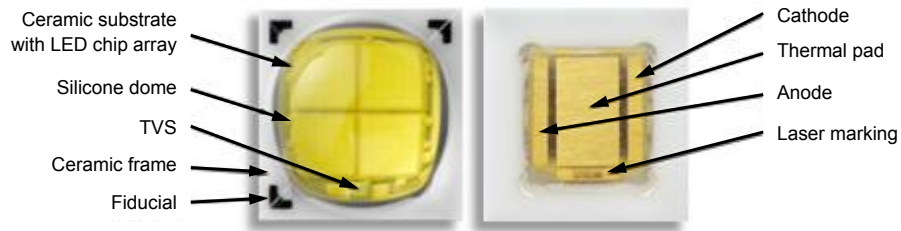

Figure 3. Pad configuration.

Note for Figure 3:

1. The thermal pad is electrically isolated from the anode and cathode contact pads.

Solder Pad Design

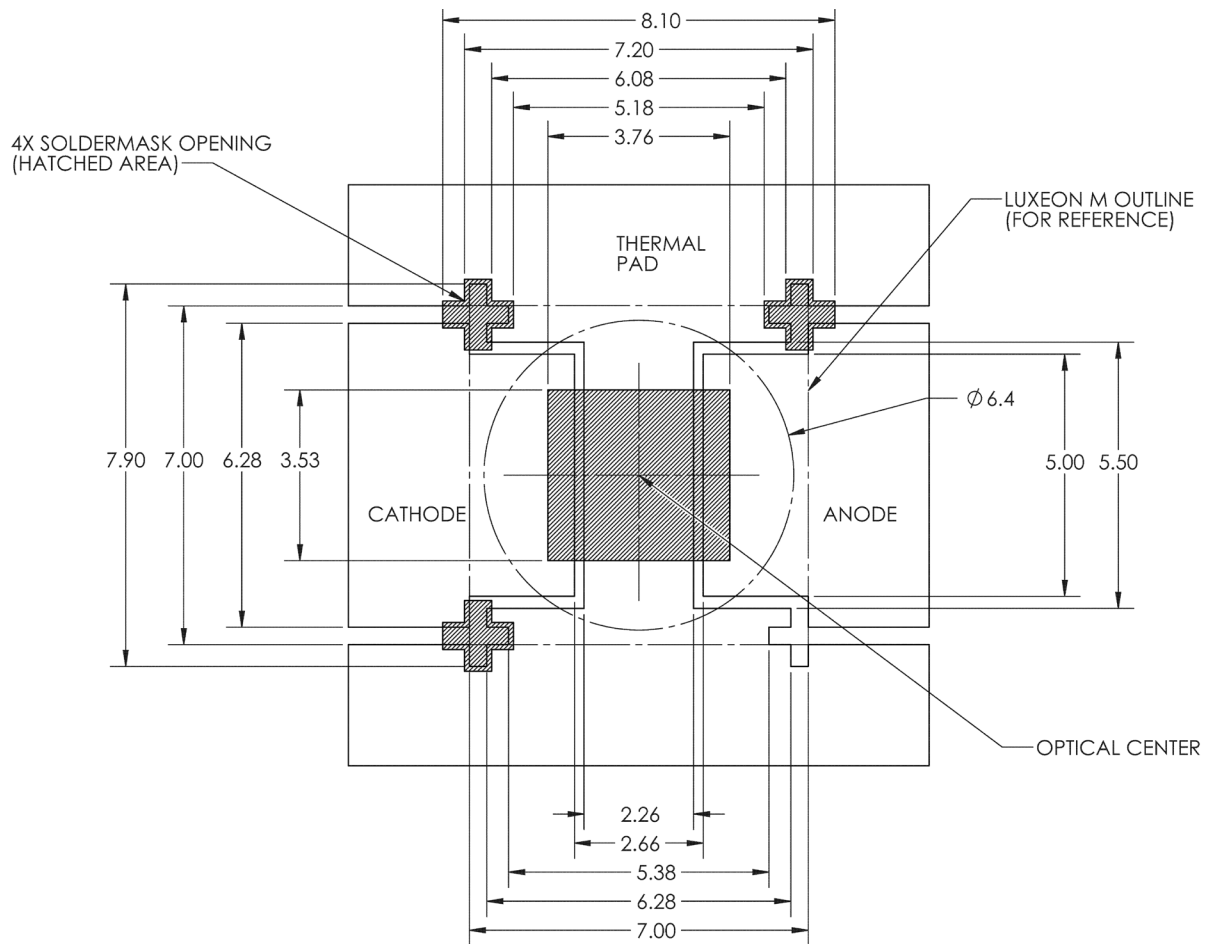

Figure 4. Recommended LUXEON M footprint design for Metal Core PCB. All dimensions are in millimeters.

Notes for Figure 4:

1. The LUXEON M Application Brief provides extensive details for this layout.
2. Printed Circuit Board layout files (.dwg) are available at www.philipslumileds.com and www.philipslumileds.cn.com

Relative Spectral Distribution vs. Wavelength Characteristics

LXR7-xWxx (White) at Test Current, Junction Temperature = 85°C

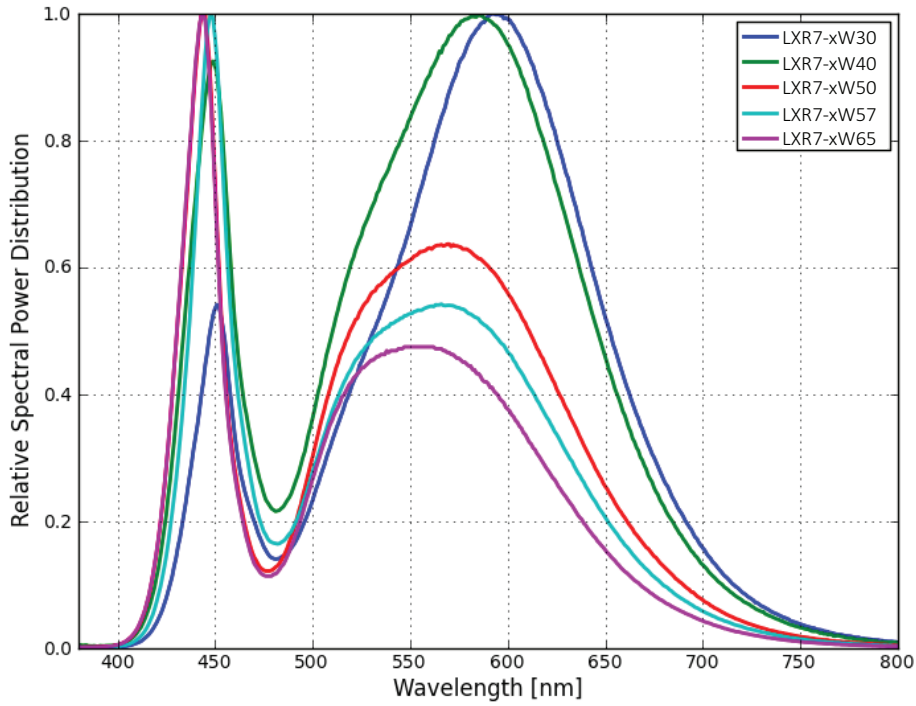

Figure 5. Color spectrum of LXR7-xWxx emitter, integrated measurement.

LXR8-xWxx (White) at Test Current, Junction Temperature = 85°C

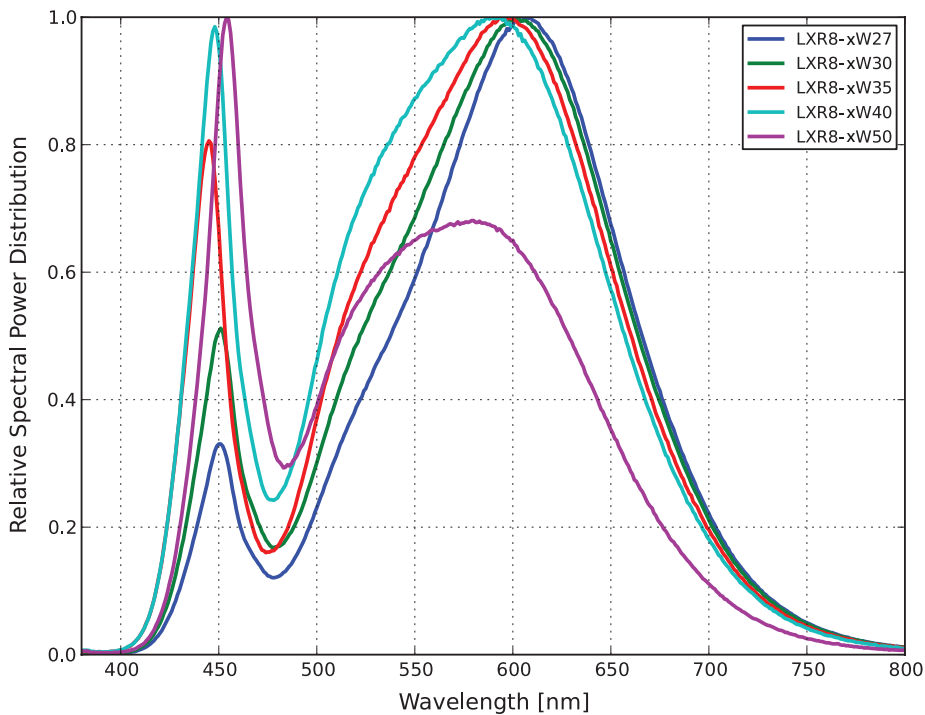

Figure 6. Color spectrum of LXR8-xWxx emitter, integrated measurement.

LXR9-xWxx (White) at Test Current, Junction Temperature = 85°C

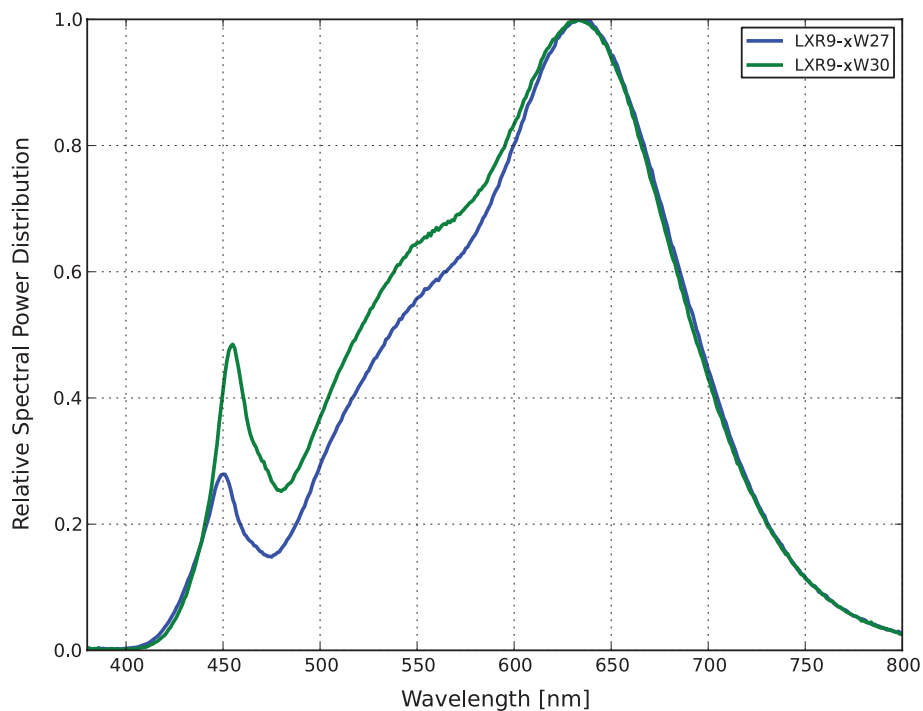

Figure 7. Color spectrum of LXR9-xWxx emitter, integrated measurement.

LXR0-xR00 (Royal Blue) at Test Current, Junction Temperature = 85°C

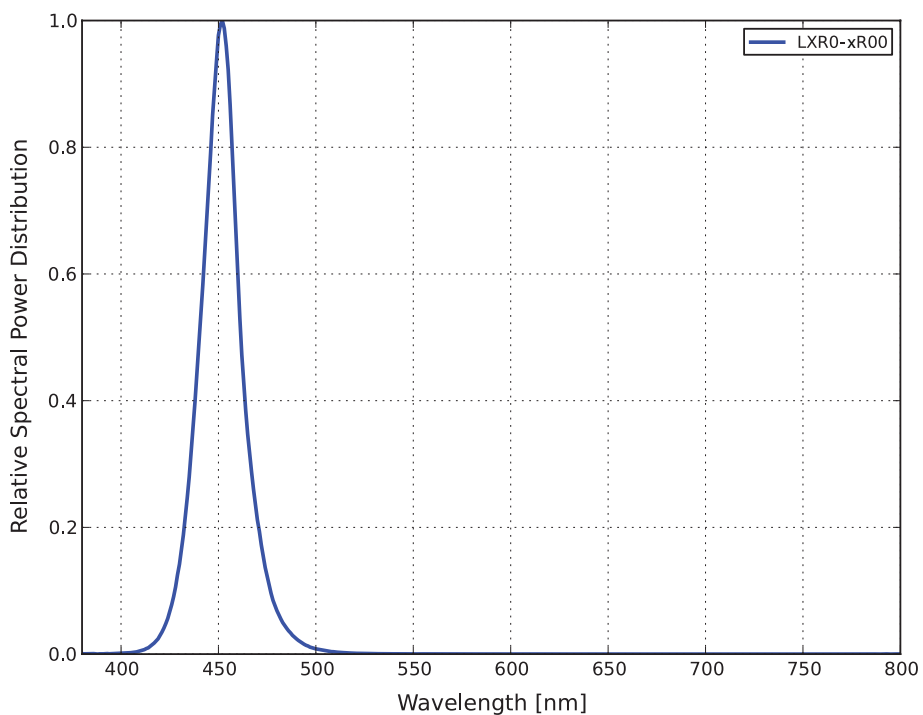

Figure 8. Color spectrum of LXR0-xR00 emitter, integrated measurement.

Typical Light Output Characteristics

Typical Relative Light Output Characteristics over Temperature at Test Current of 700/1400 mA for LXR_x-xW_{xx} (White) and LXR0-xR00 (Royal Blue)

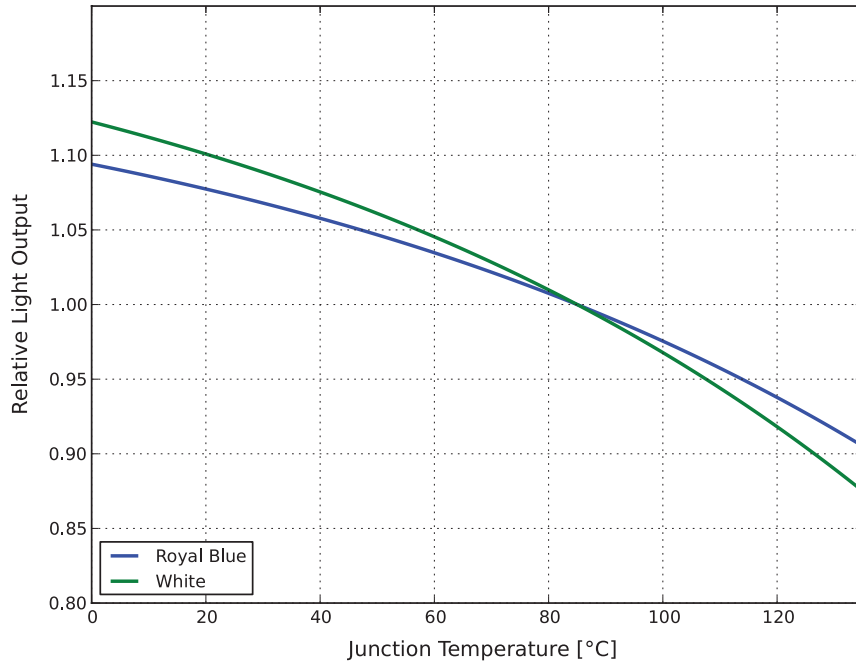

Figure 9. Relative light output vs. junction temperature.

Typical Relative Luminous Flux vs. Forward Current, Junction Temperature = 85°C for LXR_x-SW_{xx} (White) and LXR0-SR00 (Royal Blue)

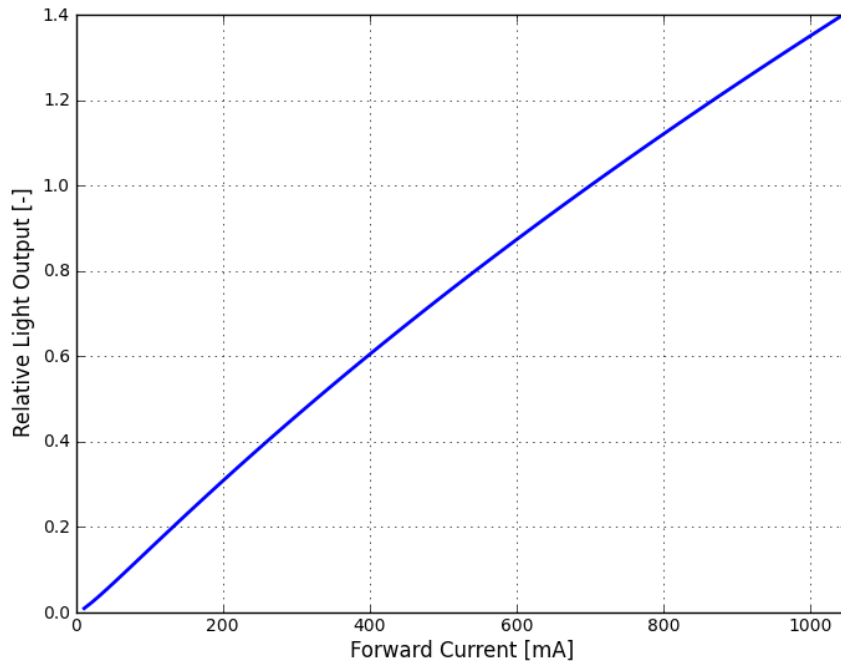

Figure 10. Relative light output vs. forward current (12V).

Typical Light Output Characteristics

Typical Relative Luminous Flux vs. Forward Current, Junction Temperature = 85°C
for LXR_x-RW_{xx} (White) and LXR0-RR00 (Royal Blue)

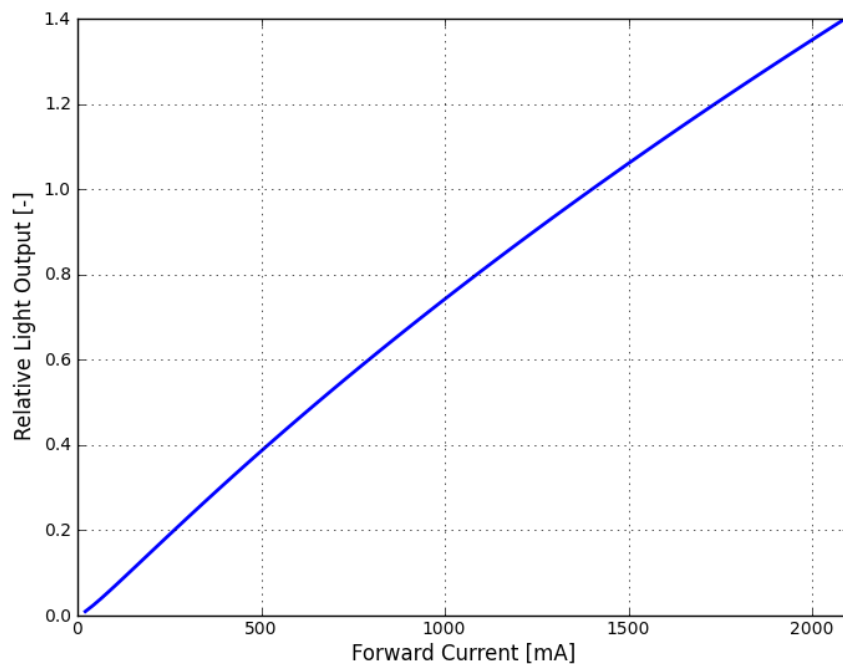

Figure 11. Relative light output vs. forward current (6V).

Forward Current Characteristics

Typical Forward Current vs. Forward Voltage, Junction Temperature = 85°C for LXR_x-SW_{xx} (White) and LXR0-SR00 (Royal Blue)

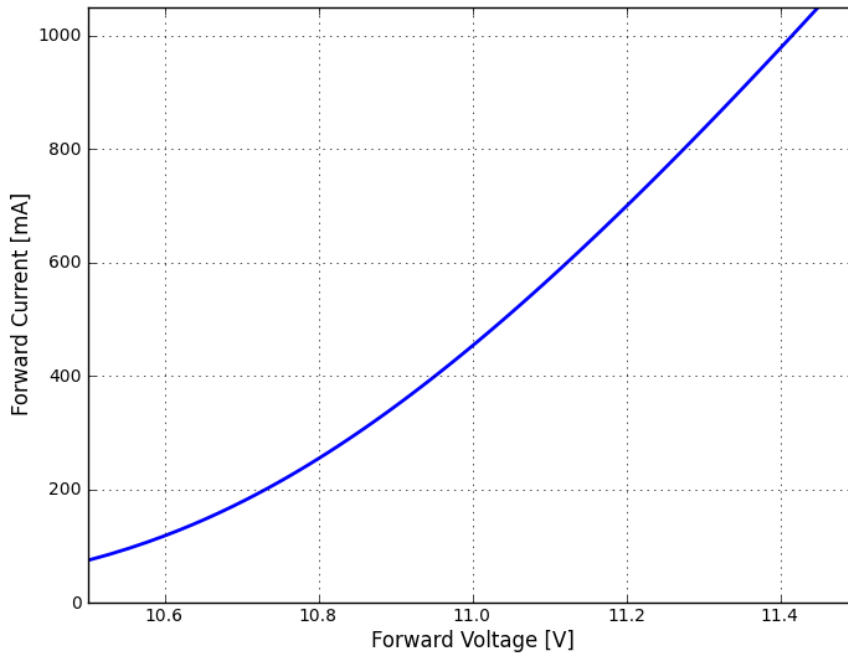

Figure 12. Forward current vs. forward voltage (12V).

Typical Forward Current vs. Forward Voltage, Junction Temperature = 85°C for LXR_x-RW_{xx} (White) and LXR0-RR00 (Royal Blue)

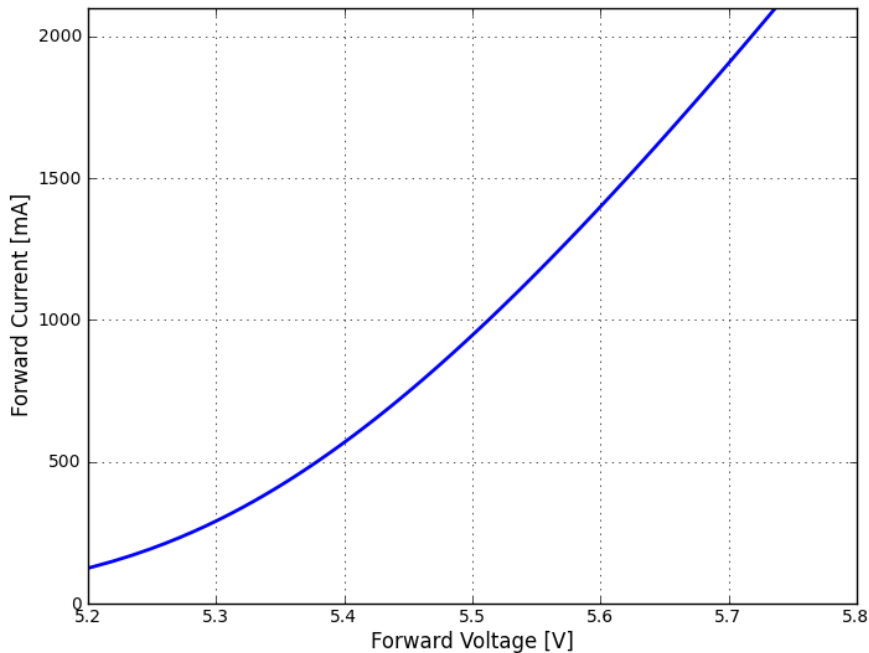

Figure 13. Forward current vs. forward voltage (6V).

Typical Radiation Patterns

Typical Spatial Radiation Pattern for LXR_x-xW_{xx} (White) and LXR0-xR00 (Royal Blue)

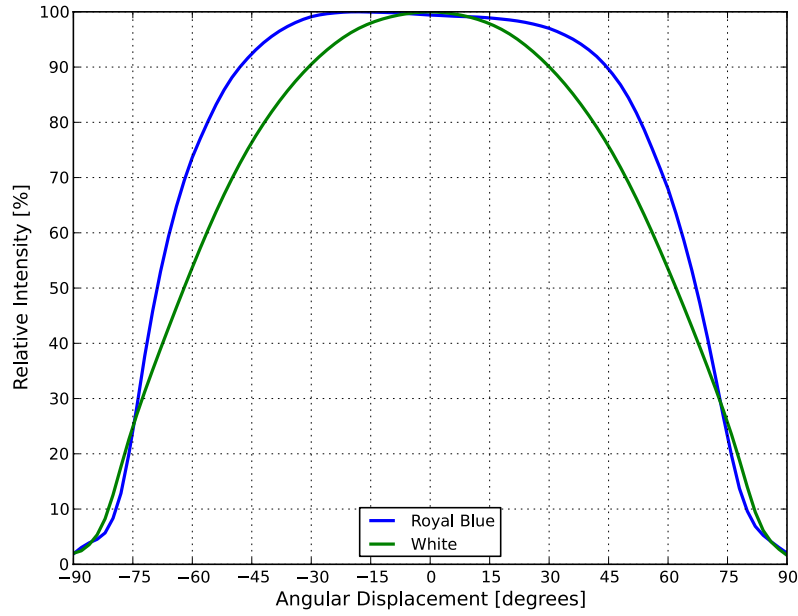

Figure 14. Typical representative spatial radiation pattern.

Typical Polar Radiation Pattern for LXR_x-xW_{xx} (White) and LXR0-xR00 (Royal Blue)

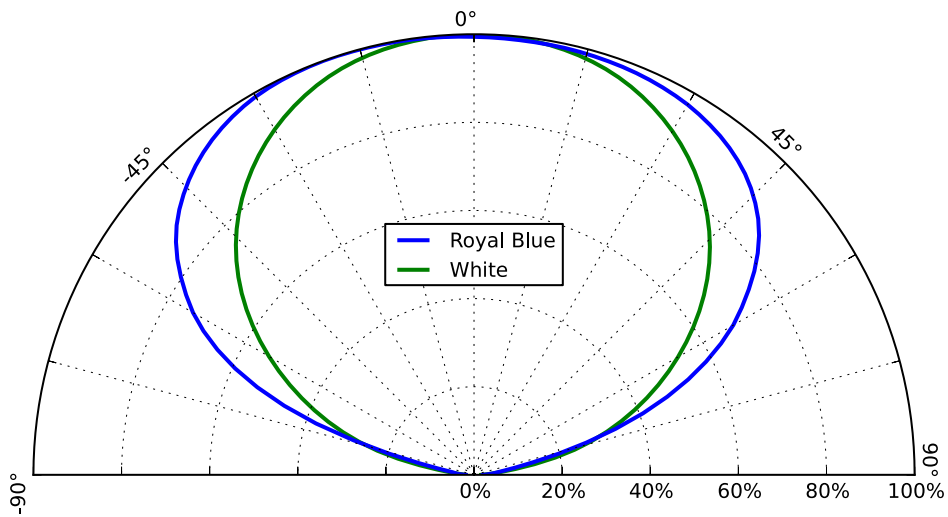

Figure 15. Typical polar radiation pattern.

Emitter Pocket Tape Packaging

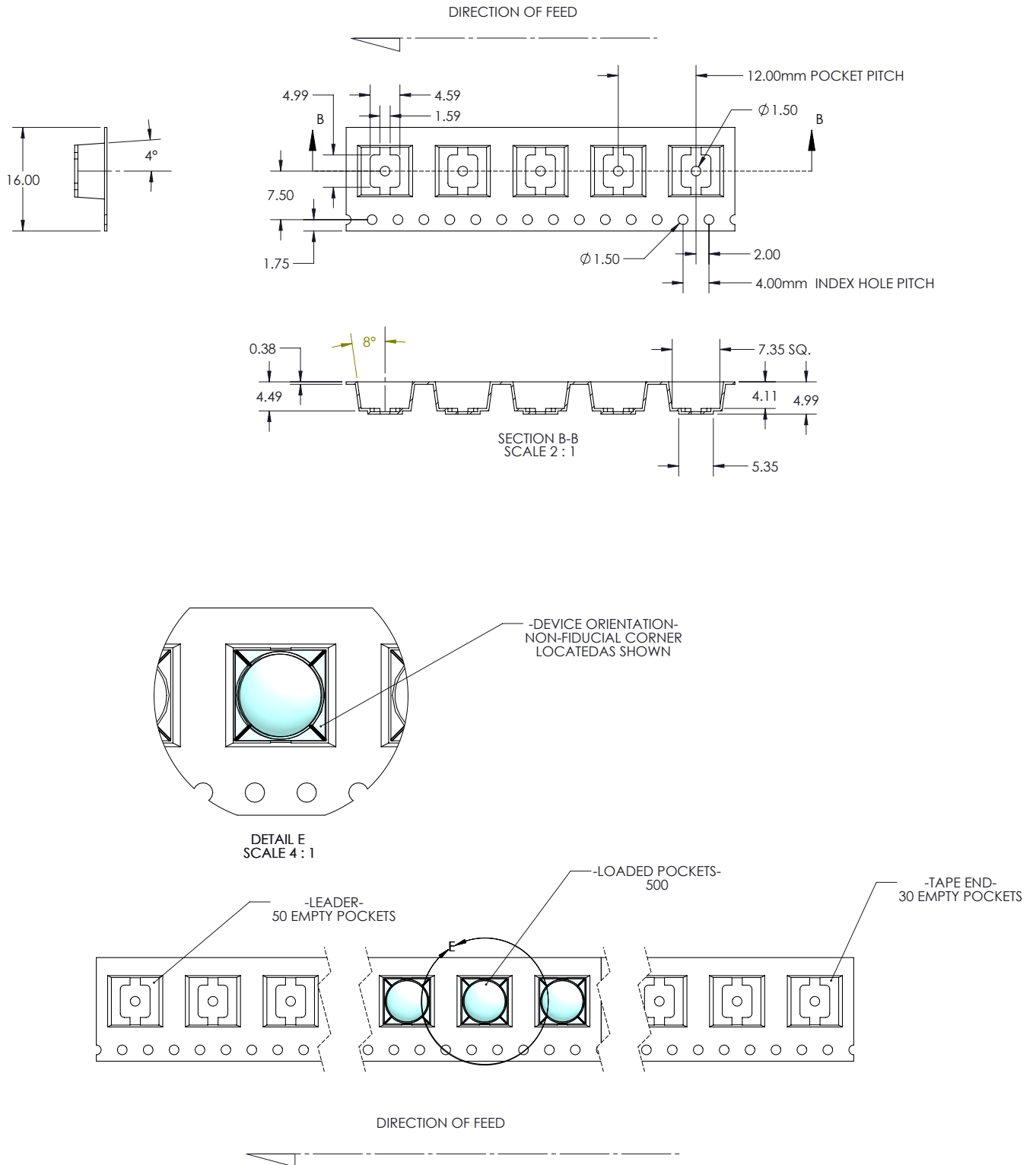

Figure 16. Emitter pocket tape packaging.

Emitter Reel Packaging

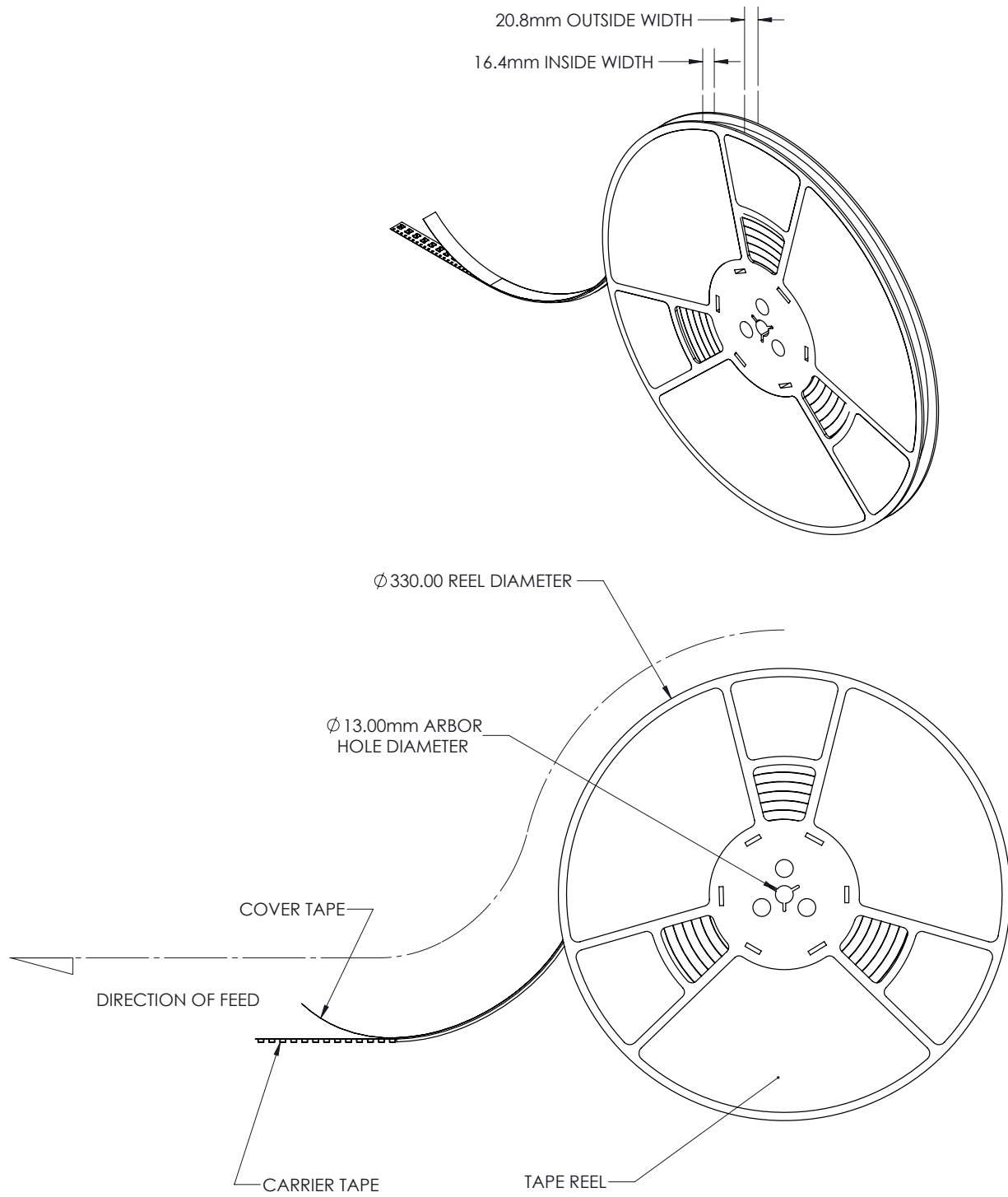

Figure 17. Emitter reel packaging.

Product Binning and Labeling

Purpose of Product Binning

In the manufacturing of semiconductor products, there is a variation of performance around the average values given in the technical data sheets. For this reason, Philips Lumileds bins the LED components for luminous flux, color, and forward voltage (V_f).

Decoding Product Bin Labeling

Reels with LUXEON M White emitters are labeled with a four digit alphanumeric code (CAT code) following the format below. All emitters packaged within a reel are of the same 4-variable bin combination.

For LXR x -xW xx , Reels of emitters are labeled with a four digit alphanumeric CAT code following the format below.

ABCD

A = Luminous flux bin (See table 9)

B = Color or CCT indication (2 for 5700K, 3 for 5000K, 5 for 4000K, 6 for 3500K, 7 for 3000K, and 8 for 2700K)

C = Color consistency (5 for within 5 SDCM ellipse, 3 for within 3SCDM ellipse). Detailed definitions for these color bins can be found in Table 11.

D = V_f bin (F,G,H)

Reels with LUXEON M Royal Blue emitters are labeled with a three digit alphanumeric CAT code following the format below. All emitters packaged within a reel are of the same 4-variable bin combination.

ABC

A = Radiometric Power Bin (See table 10)

B = Peak wavelength bin (See table 12)

C = V_f bin (F,G,H)

Luminous Flux Bins

Table 11 lists the standard photometric luminous flux bins for LUXEON M white emitters (LXR_x-xW_{xx}). Test conditions for LXR_x-SW_{xx} are 700 mA and junction temperature 85°C. Test conditions for LXR_x-RW_{xx} are 1400 mA and junction temperature 85°C.

Although several bins are outlined, product availability in a particular bin varies by production run and by product performance.

Table 11. Luminous Flux Bins for White

Bin Code	Minimum Photometric Flux (lm)	Maximum Photometric Flux (lm)
J	510	550
K	550	590
L	590	630
M	630	680
N	680	730
P	730	780
Q	780	840
R	840	900
S	900	970
T	970	1040
U	1040	1120
V	1120	1200

Radiometric Power Bins

Table 12 lists the standard radiometric flux bins for LUXEON M Royal Blue emitters LXR0-SR00 and LXR0-RR00. Test conditions for LXR0-SR00 are 700mA and junction temperature 85°C. Test conditions for LXR0-RR00 are 1400mA and junction temperature 85°C.

Table 12. Radiometric Power Bins for Royal Blue

Bin Code	Minimum Radiometric Flux (mW)	Maximum Radiometric Flux (mW)
A	4000	4200
B	4200	4400
C	4400	4600
D	4600	4800
E	4800	5000

LUXEON M Color Bin Definition

LUXEON M 3- and 5-step MacAdam Ellipse White Color Bin Definition for LXR_x-SW_{xx} and LXR_x-RW_{xx}

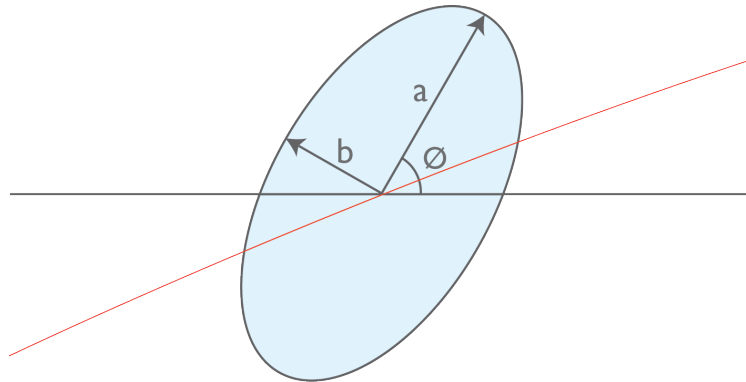

Table 13. LUXEON M Color Bin Definitions

Part Number	Nominal ANSI CCT	Color Space	Center Point (cx, cy)	Major Axis, a	Minor Axis, b	Ellipse Rotation Angle (degrees)
LXR7-SW30, LXR7-RW30	3000K	Single 5-step MacAdam ellipse	0.4338, 0.4030	0.01390	0.00680	53.22
LXR7-SW40, LXR7-RW40	4000K	Single 5-step MacAdam ellipse	0.3818, 0.3797	0.01565	0.00670	53.72
LXR7-SW50, LXR7-RW50	5000K	Single 5-step MacAdam ellipse	0.3447, 0.3553	0.01370	0.00590	59.62
LXR7-SW57, LXR7-RW57	5700K	Single 5-step MacAdam ellipse	0.3287, 0.3417	0.01243	0.00533	59.09
LXR7-SW65, LXR7-RW65	6500K	Single 5-step MacAdam ellipse	0.3123, 0.3282	0.01115	0.00475	58.57
LXR8-SW27, LXR8-RW27 LXR9-SW27, LXR9-RW27	2700K	Single 3-step MacAdam ellipse	0.4578, 0.4101	0.00810	0.00420	53.70
LXR8-SW30, LXR8-RW30 LXR9-SW30, LXR9-RW30	3000K	Single 3-step MacAdam ellipse	0.4338, 0.4030	0.00834	0.00408	53.22
LXR8-SW35, LXR8-RW35	3500K	Single 3-step MacAdam ellipse	0.4073, 0.3917	0.00927	0.00414	54.00
LXR8-SW40, LXR8-RW40	4000K	Single 3-step MacAdam ellipse	0.3818, 0.3797	0.00939	0.00402	53.72
LXR8-SW50, LXR8-RW50	5000K	Single 3-step MacAdam ellipse	0.3447, 0.3553	0.00822	0.00354	59.62

Notes for Table 13:

1. Philips Lumileds maintains a tester tolerance of ± 0.005 on x, y color coordinates.
2. Tested at 700 mA D.C. and Junction Temperature = 85°C.

Peak Wavelength Bin Definition for LXR0-SR00 and LXR0-RR00

Table 14. Peak Wavelength Bin Structure for Royal Blue

Bin Code	Minimum Peak Wavelength (nm)	Maximum Peak Wavelength (nm)
4	445	450
5	450	455
6	455	460

Forward Voltage Bins

Tables 15 and 16 list minimum and maximum Vf bin values per emitter. Although several bins are outlined, product availability in a particular bin varies by production run and by product performance.

Table 15. Forward Voltage Bins for LXR_x-SW_{xx} and LXR0-SR00

Bin Code	Minimum Forward Voltage (V)	Maximum Forward Voltage (V)
F	10.5	11.0
G	11.0	11.5
H	11.5	12.0

Table 16. Forward Voltage Bins for LXR_x-RW_{xx} and LXR0-RR00

Bin Code	Minimum Forward Voltage (V)	Maximum Forward Voltage (V)
F	5.25	5.50
G	5.50	5.75
H	5.75	6.00

Company Information

Philips Lumileds is a leading provider of LEDs for everyday lighting applications. The company's records for light output, efficacy and thermal management are direct results of the ongoing commitment to advancing solid-state lighting technology and enabling lighting solutions that are more environmentally friendly, help reduce CO2 emissions and reduce the need for power plant expansion. Philips Lumileds LUXEON® LEDs are enabling never before possible applications in outdoor lighting, shop lighting, home lighting, digital imaging, display and automotive lighting.

Philips Lumileds is a fully integrated supplier, producing core LED material in all three base colors, (Red, Green, Blue) and white. Philips Lumileds has R&D centers in San Jose, California and in the Netherlands, and production capabilities in San Jose, Singapore and Penang, Malaysia. Founded in 1999, Philips Lumileds is the high flux LED technology leader and is dedicated to bridging the gap between solid-state technology and the lighting world. More information about the company's LUXEON LED products and solid-state lighting technologies can be found at www.philipslumileds.com.

Philips Lumileds Lighting Company shall not be liable for any kind of loss of data or any other damages, direct, indirect or consequential, resulting from the use of the provided information and data. Although Philips Lumileds Lighting Company has attempted to provide the most accurate information and data, the materials and services information and data are provided "as is" and Philips Lumileds Lighting Company neither warranties, nor guarantees the contents and correctness of the provided information and data. Philips Lumileds Lighting Company reserves the right to make changes without notice. You as user agree to this disclaimer and user agreement with the download or use of the provided materials, information and data.



©2013 Philips Lumileds Lighting Company. All rights reserved.
LUXEON is a registered trademark of the Philips Lumileds Lighting Company in the United States and other countries.

www.philipslumileds.com
www.philipslumileds.cn.com