

## Big Chip LED PT121 LED Projection Chipset



### Table of Contents

Technology Overview . . . . .	2
Understanding Big Chip Test Specifications . . . . .	2
Ordering Information . . . . .	3
Flux /Power Bin Definition . .	4
Optical & Electrical Characteristics . . . . .	5-6
Blue Flux Bin Ranges by Wavelength . . . . .	7
Parametric Graphs . . . . .	8-9
Thermal Resistance . . . . .	10
Mechanical Dimensions . .	11
Shipping Tray Outline . . . .	12
Packing and Shipping Specifications . . . . .	13
History of Changes . . . . .	14

### Features:

- Matched RGB Chipset with 12mm<sup>2</sup> emitting area designed for projection applications
- Photonic lattice technology for very high surface brightness
- 100% surface emission for high collection efficiency and low optical losses
- Wide color gamut: RED 623 nm, RED-AMBER 615 nm, GREEN 525 nm, Blue 460nm typical dominant wavelength
- Single emitting area per color allows for collection with single lens for simplified optics
- 4:3 aspect ratio matched with micro-display and screen aspect ratio
- Uniform surface emission
- Thermally efficient Common Anode copper-core PCB package
- RoHS (EU-2002/95/EC Directive) and REACH compliant

### Applications

- Data front projectors and professional Rear-Projection Displays with 4:3 aspect ratio
- Optimized for Micro-Display diagonal sizes ranging from 0.7" to 0.96" with 4:3 aspect ratio.
- Suitable for DLP™(0.7"XGA, 0.96SXGA), LCoS, HTPS and 3LCD microdisplays

## Technology Overview

Luminus Devices' Projection Technology (PT) is an innovative solid-state light source created to replace arc lamps in projection systems, enabling a new category of lamp-free projectors. Enabled by unique use of Photonic Lattice technology, Phlat-Light chipsets represent a major breakthrough in brightness that delivers all the benefits of solid state light sources in projections applications, including wide color gamut for vivid colors, exceeds NTSC, Environmentally friendly technology (Mercury-free), instant start and re-start with no more wait time, high reliability; no more lamp replacement, and electronic control of color points and light intensity on a frame by frame basis. PhlatLight products benefit from numerous innovations in the domain of packaging, thermal management and optical coupling that allow designers to achieve efficient light engine designs and deliver high screen brightness.

### Photonic Lattice Technology

Luminus' photonic lattice technology enables large area LED chips with uniform brightness over the entire LED chip surface. The optical power and brightness produced by these large monolithic chips enable solutions which replace arc and halogen lamps where arrays of traditional high power LEDs cannot.

For red, green and blue LEDs, the photonic lattice structures extract more light and create radiation patterns that are more collimated than traditional LEDs. (Having higher collimation from the source increases optical collection efficiencies and simplifies optical designs.)

### Packaging Technology

Thermal management is critical in high power LED applications. With a thermal resistance from junction to case of  $0.6^{\circ}\text{C/W}$ , Luminus PT121 LEDs can be driven at higher current densities while maintaining a low junction temperature, thereby resulting in brighter solutions and longer lifetimes.

### Reliability

For high power operation, Luminus Big Chip LEDs are one of the most reliable light sources in the world today. Big Chip LEDs have passed a rigorous suite of environmental and mechanical stress tests, including mechanical shock, vibration, temperature cycling and humidity, and have been fully qualified for use in extreme high power and high current applications. With very low failure rates and median lifetimes that typically exceed 60,000 hours, Luminus Big Chip LEDs are ready for even the most demanding applications. (Please refer to Luminus' Reliability application note for more information.)

### Environmental Benefits

Luminus LEDs help reduce power consumption and the amount of hazardous waste entering the environment. All Big Chip LED products manufactured by Luminus are RoHS and REACH compliant and free of hazardous materials, including lead and mercury.

## Understanding Big Chip LED Test Specifications

Every Luminus LED is extensively tested at full current to ensure that it meets the high quality standards expected from Luminus' products.

### Testing of Big Chip LEDs

Luminus core board products are typically measured in such a way that the characteristics reported agree with how the devices will actually perform when incorporated into a system. This measurement is accomplished by mounting the devices on a  $40^{\circ}\text{C}$  heat sink and allowing the device to reach thermal equilibrium while fully powered. Only after the device reaches equilibrium are the measurements taken. This method of measurement ensures that Luminus Big Chip LEDs perform in the field just as they are specified.

Luminus surface mount LEDs are typically tested with a 20mSec

input pulse and a junction temperature of  $25^{\circ}\text{C}$ . Expected flux values in real world operation can be extrapolated based on the information contained within this product data sheet.

### Ordering Information

Ordering Part Number <sup>1</sup>	Color	Min Flux Bin <sup>2</sup>	Description
PT-121-R-C11-MPB	Red	5A1	Red LED, consisting of a 12 mm <sup>2</sup> LED chip (4:3 aspect ratio), thermistor and connector mounted on a copper-core PCB.
PT-121-R-C11-MPC		5A2	
PT-121-R-C11-MPD		5B	
PT-121-RA-C11-MPE	Red Amber	5C	Red-Amber LED, consisting of a 12 mm <sup>2</sup> LED chip (4:3 aspect ratio), thermistor and connector mounted on a copper-core PCB.
PT-121-RA-C11-MPF		5D	
PT-121-G-C11-MPB	Green	5A	Green LED, consisting of a 12 mm <sup>2</sup> LED chip (4:3 aspect ratio), thermistor and connector mounted on a copper-core PCB.
PT-121-G-C11-MPC		5B	
PT-121-G-C11-MPD		5C	
PT-121-G-C11-MPE		5D	
PT-121-G-C11-MPF		5E	
PT-121-B-C11-EPA	Blue	5C	Blue LED, consisting of a 12 mm <sup>2</sup> LED chip (4:3 aspect ratio), thermistor and connector mounted on a copper-core PCB.
PT-121-B-C11-EPB		5D	
PT-121-B-C11-EPC		5E	

Note 1: Ordering part numbers represent bin kits (group of bins that are shippable for a given ordering part number)

Note 2: See Bin Kit and Flux bin definitions on page 4.

### Ordering Part Number Nomenclature

PT — nn — XXXX — C11 — XYZ

Product Family	Chip Area	Color	Package Configuration	Bin Kit <sup>1</sup>
PT: Copper-core PCB	121: 12 mm <sup>2</sup>	R= Red (623nm, typ) RA= Red -Amber (615nm, typ) G= Green B= Blue	C11: 28 mm x 26.75 mm  See Mechanical Drawing section	See page 4 for bin kit definition

Note 1: A Bin Kit represents a group of individual flux or power bins that are shippable for a given ordering part number. Individual flux bins are not orderable.

EXAMPLES:

PT-121-R-C11-MPD is comprised of Red Flux Bins 5B, 5C, 5D, 5E, 5F, 5G, 5H.

### PT121 Bin Kit<sup>1</sup> and Flux Bin<sup>2,3,4</sup> Definitions

Note: Please refer to ordering part number table on page 3 for Bin Kit availability

Red Flux Bins	Bin 5A1	Bin 5A2	Bin 5B	Bin 5C	Bin 5D	Bin 5E	Bin 5F	Bin 5G	Bin 5H	Bin 5J	Bin 5K
Red Bin Flux Range <sup>4</sup> (lm)	1300-1360	1360-1400	1400-1490	1490-1630	1630-1760	1760-1900	1900-2050	2050-2225	2225-2400	nd	nd
PT-121-R-C11-MPB	☑	☑	☑	☑	☑	☑					
PT-121-R-C11-MPC		☑	☑	☑	☑	☑	☑	☑			
PT-121-R-C11-MPD			☑	☑	☑	☑	☑	☑	☑		
Red -Amber Flux Bins	Bin 5C	Bin 5D	Bin 5E	Bin 5F	Bin 5G	Bin 5H	Bin 5J	Bin 5K	Bin 5L		
Red -Amber Bin Flux Range <sup>4</sup> (lm)	1490 - 1630	1630-1760	1760-1900	1900-2025	2025-2150	2150-2300	2300-2450	2450-2625	2625-2800		
PT-121-RA-C11-MPE	☑	☑	☑	☑	☑	☑					
PT-121-RA-C11-MPF		☑	☑	☑	☑	☑	☑				
Green Flux Bins	Bin 5A	Bin 5B	Bin 5C	Bin 5D	Bin 5E	Bin 5F	Bin 5G	Bin 5H	Bin 5J	Bin 5K	Bin 5L
Green Bin Flux Range <sup>4</sup> (lm)	2700-2880	2880-3080	3080-3280	3280-3460	3460-3660	3660-3840	3840-4000	4000-4200	4200-4400	4400-4650	4650-4900
PT-121-G-C11-MPB	☑	☑	☑	☑	☑	☑					
PT-121-G-C11-MPC		☑	☑	☑	☑	☑	☑				
PT-121-G-C11-MPD			☑	☑	☑	☑	☑	☑			
PT-121-G-C11-MPE				☑	☑	☑	☑	☑	☑		
PT-121-G-C11-MPF					☑	☑	☑	☑	☑	☑	
Blue Power Bins	Bin 5C	Bin 5D	Bin 5E	Bin 5F	Bin 5G	Bin 5H	Bin 5J	Bin 5K	Bin 5L		
Blue Bin Flux Range <sup>5</sup> (lm)	550-615	615-680	680-750	750-815	815-880	880-940	940-1000	1000-1070	1070-1145		
PT-121-B-C11-EPA	☑	☑	☑	☑	☑						
PT-121-B-C11-EPB		☑	☑	☑	☑	☑					
PT-121-B-C11-EPC			☑	☑	☑	☑	☑				

Note 1: Bin Kits are defined by a group of flux or power bins. Only one flux bin will be shipped in each individual pack. A shipment will contain packs of different allowed flux bins for a particular ordering part number. In order to ensure availability, individual Flux or Power bins are not orderable.

Note 2: PT121 LEDs are tested for luminous flux at 30A at 25% duty cycle for Red, Red-Amber and Blue, and at 50% duty cycle for Green Devices. Devices are sorted and packed by flux bin. Not all flux bins are currently populated.

Note 3: Luminus maintains a test measurement accuracy for LED flux and power of +/- 6%.

Note 4: Red and Green Flux bin limits apply across entire dominant wavelength range. Dominant wavelength range for Red and Green devices are specified on page 5.

Note 5: Blue Flux bin limits are defined at dominant wavelength, 462nm.

### Optical & Electrical Characteristics

General Characteristics		Symbol	Red	Red -Amber Preliminary	Green	Blue	Unit
Emitting Area			12	12	12	12	mm <sup>2</sup>
Emitting Area Dimensions			4 x 3	4 x 3	4 x 3	4 x 3	mmxmm
Characteristics at Recommended Test Drive Current , I <sub>F</sub> <sup>1,2</sup>							
Reference Duty Cycle <sup>3</sup>			25	25	50	25	%
Test Peak Drive Current <sup>1,2,4</sup>	typ	I <sub>F</sub>	30	30	30	30	A
Peak Luminous Flux <sup>1,2,5</sup>	typ	Φ <sub>v</sub>	1625	2050	4000	675	lm
Peak Radiometric Flux <sup>1,2</sup>	typ	Φ <sub>r</sub>	9.2	8.2	8.6	15.6	W
Dominant Wavelength	min	λ <sub>dmin</sub>	619	611	516	450	nm
	typ	λ <sub>d</sub>	623	615	525	460	nm
	max	λ <sub>dmax</sub>	630	622	535	468	nm
FWHM- Spectral bandwidth at 50% of Φ <sub>v</sub>	typ		19	19	36	20	nm
Chromaticity Coordinates <sup>6,7</sup>	typ	x	0.698	0.680	0.167	0.147	
	typ	y	0.302	0.320	0.704	0.033	
Forward Voltage	min	V <sub>Fmin</sub>	2.2	2.2	3.5	3.2	V
	typ	V <sub>F</sub>	2.6	2.6	4.9	4.0	V
	max	V <sub>Fmax</sub>	3.4	3.4	5.9	5.2	V
Dynamic Resistance	typ	Ω <sub>dyn</sub>	0.02	0.02	0.03	0.02	Ω
Device Thermal Characteristics							
Thermal Coefficient of Photometric Flux	typ		-1.1	tbd	-0.2	-0	% / °C
Thermal Coefficient of Radiometric Flux	typ		-0.7	tbd	-0.2	-0.2	% / °C
Forward Voltage Temperature Coefficient	typ		-3.0	tbd	-3.0	-3.0	mV/ °C
Characteristics at Reference Continuous Drive Current I <sub>F</sub> (continuous wave) <sup>1</sup>							
Reference Drive Current	typ	I <sub>F</sub>	18	18	18	18	A
Luminous Flux	typ	Φ <sub>v</sub>	910	1150	2800	485	lm
Radiometric Flux	typ	Φ <sub>r</sub>	5.2	4.5	5.7	9.5	W
Dominant Wavelength	typ	λ <sub>d</sub>	624	616	528	462	nm
FWHM -Spectral bandwidth at 50% of Φ <sub>v</sub>	typ		18	18	36	21	nm
Chromaticity Coordinates <sup>6,7</sup>	typ	x	0.700	0.682	0.171	0.145	nm
	typ	y	0.300	0.398	0.702	0.036	nm
Forward Voltage	typ	V <sub>F</sub>	2.3	2.3	4.4	3.4	V
Dynamic Resistance	typ	Ω <sub>dyn</sub>	0.02	0.02	0.03	0.05	Ω

## Optical & Electrical Characteristics

Note 1: All ratings are based on testing conditions with a constant heat sink temperature  $T_{hs} = 40^{\circ}\text{C}$ . See Thermal Resistance section for  $T_{hs}$  definition.

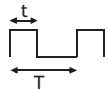
Note 2: Parameters rated at test duty cycle and Pulsed operation frequency  $f > 240\text{Hz}$ ;  $DC = \frac{t}{T}$  

Note 3: Duty Cycle used to specify device ratings under Pulsed operation. Big Chip LED devices can operate at duty cycles ranging from 1% to 100%. At higher duty cycles, drive current should be adjusted to maintain the junction temperature at desired levels to meet the application lifetime requirements.

Note 4: In pulsed operation, rise time from 10 to 90% of forward current should be larger than 0.5 microseconds

Note 5: For Blue devices, total flux from emitting area at typical dominant wavelength. Refer to page 7 for brightness specifications at other wavelength

Note 6: In CIE 1931 chromaticity diagram coordinates, normalized to  $X+Y+Z=1$

Note 7: For Reference only

### Absolute Maximum Ratings

		Symbol	Red	Red - Amber	Green	Blue	Unit
Minimum Current (CW or Pulsed) <sup>1</sup>			200	200	200	200	mA
Maximum Current (CW) <sup>1</sup>	Max		30	30	30	30	A
Maximum Current (Pulsed) <sup>2,3</sup> (Frequency > 240 Hz, duty cycle < 60%)	Max		36	36	36	36	A
Absolute Maximum Junction Temperature <sup>4</sup>		$T_{jmax}$	110	110	170	170	$^{\circ}\text{C}$
Storage Temperature Range			-40 / +100	-40 / +100	-40 / +100	-40 / +100	$^{\circ}\text{C}$

Note 1: Product performance and lifetime data is specified at recommended forward drive currents. Sustained operation at or near absolute minimum currents may result in a reduction of device performance and device lifetime compared to recommended forward drive currents.

Note 2: Luminus PhlatLight LEDs are designed for operation to an absolute maximum forward drive current density of 2.5A/mm<sup>2</sup> CW, and 3A/mm<sup>2</sup> pulsed ( $f > 240\text{Hz}$ , duty cycle < 60%). Please refer to absolute maximum rating table above for specific absolute maximum currents for the products covered in this datasheet. Product lifetime data is specified at recommended forward drive currents. Sustained operation at absolute maximum currents will result in a reduction of device lifetime compared to recommended forward drive currents. Actual device lifetimes will also depend on junction temperature. Refer to the lifetime derating curves (available from Luminus) for further information.

Note 3: In pulsed operation, rise time from 10 to 90% of forward current should be larger than 0.5 microseconds.

Note 4: Sustained operation at Maximum Operating Junction Temperature ( $T_{jmax}$ ) will result in reduced device life time.

**Blue Bin Flux Ranges by Dominant Wavelength <sup>1,2</sup>**

DWL	Bin 5C		Bin 5D		Bin 5E		Bin 5F		Bin 5G		Bin 5H		Bin 5J		Bin 5K		Bin 5L	
	Min (lm)	Max (lm)	Min (lm)	Max (lm)	Min (lm)	Max (lm)	Min (lm)	Max (lm)	Min (lm)	Max (lm)	Min (lm)	Max (lm)	Min (lm)	Max (lm)	Min (lm)	Max (lm)	Min (lm)	Max (lm)
450	269	301	301	332	332	367	367	398	398	430	430	459	459	489	489	523	523	560
451	292	327	327	361	361	399	399	433	433	468	468	500	500	531	531	569	569	608
452	316	353	353	390	390	431	431	468	468	505	505	540	540	574	574	614	614	657
453	339	379	379	419	419	462	462	503	503	543	543	580	580	617	617	660	660	706
454	363	405	405	448	448	494	494	537	537	580	580	620	620	659	659	705	705	755
455	386	432	432	477	477	526	526	572	572	618	618	660	660	702	702	751	751	804
456	409	458	458	506	506	558	558	607	607	655	655	700	700	744	744	797	797	852
457	433	484	484	535	535	590	590	641	641	693	693	740	740	787	787	842	842	901
458	456	510	510	564	564	622	622	676	676	730	730	780	780	830	830	888	888	950
459	480	536	536	593	593	654	654	711	711	768	768	820	820	872	872	933	933	999
460	503	563	563	622	622	686	686	746	746	805	805	860	860	915	915	979	979	1047
461	527	589	589	651	651	718	718	780	780	843	843	900	900	957	957	1024	1024	1096
462	550	615	615	680	680	750	750	815	815	880	880	940	940	1000	1000	1070	1070	1145
463	573	641	641	709	709	782	782	850	850	917	917	980	980	1043	1043	1116	1116	1194
464	597	667	667	738	738	814	814	884	884	955	955	1020	1020	1085	1085	1161	1161	1243
465	620	694	694	767	767	846	846	919	919	992	992	1060	1060	1128	1128	1207	1207	1291
466	644	720	720	796	796	878	878	954	954	1030	1030	1100	1100	1170	1170	1252	1252	1340
467	667	746	746	825	825	910	910	989	989	1067	1067	1140	1140	1213	1213	1298	1298	1389
468	691	772	772	854	854	942	942	1023	1023	1105	1105	1180	1180	1256	1256	1343	1343	1438

Note 1: Flux Min, Max values are continuous as function of dominant wavelength values. For illustration purposes, flux Min and Max values are provided at discrete dominant wavelength values.

Note 2: Luminus maintains a test measurement accuracy for LED flux and power of +/- 6%.

**Luminous Flux variation with Wavelength:  $\Phi_v = f(\lambda_d)$  at Recommended Operating Current  $I_F = 30$  A**

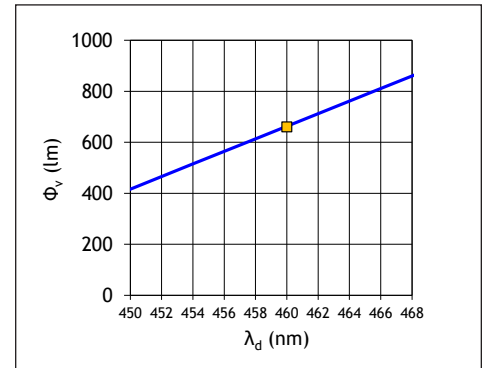
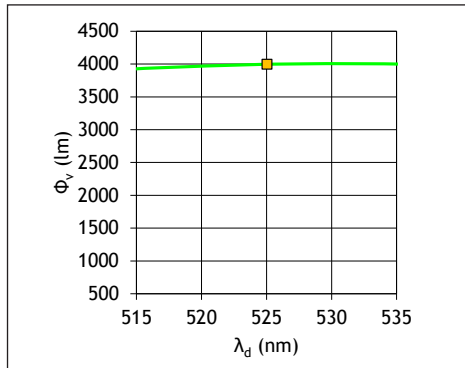
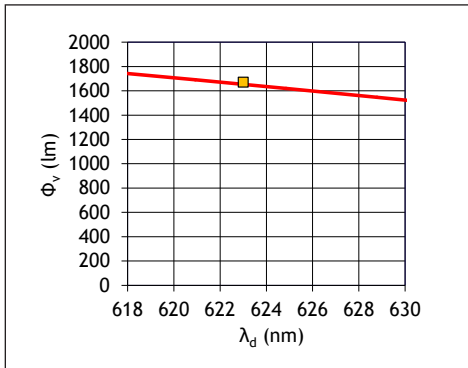

See notes 1, 3 on page 9. See note 4 on page 9 regarding Red-Amber.

**Luminous Flux variation with Drive Current -  $\Phi_v = f(I_F)$  - Typical**

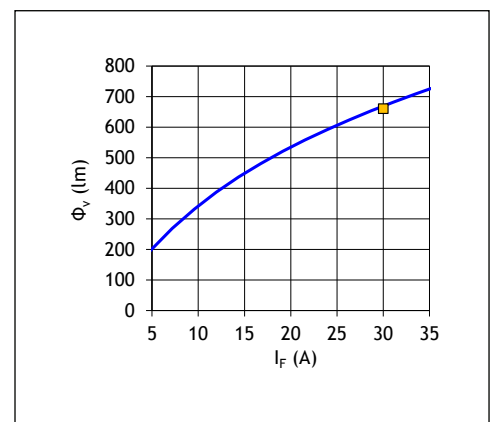
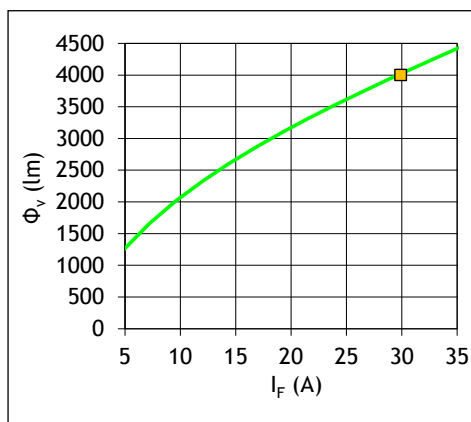
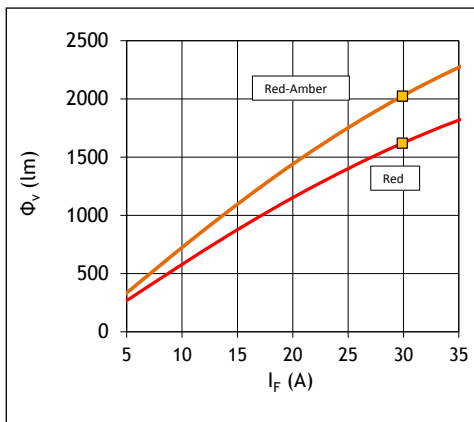

See notes 1, 2, 3 on page 9.

**Dominant Wavelength variation with Forward Current -  $\lambda_d = f(I_F)$  - Typical**

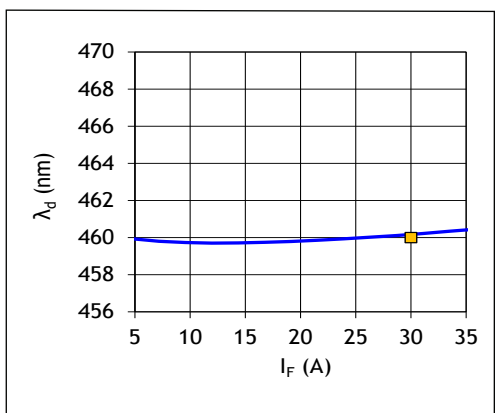
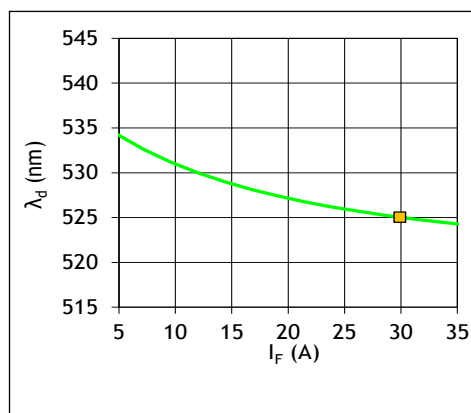
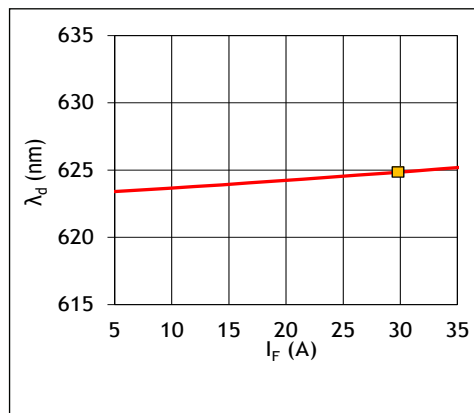

See notes 1, 2, 3 on page 9; see note 4 on page 9 regarding Red-Amber.



**Forward Voltage variation with Drive current -  $V_F = f(I_F)$  - Typical**

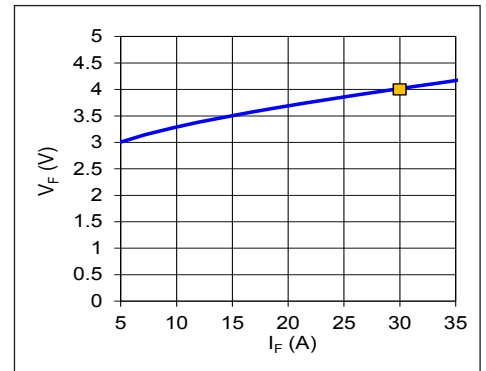
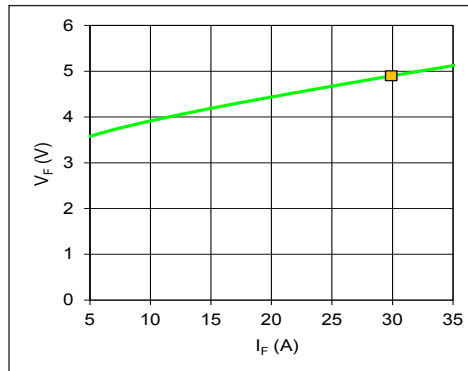
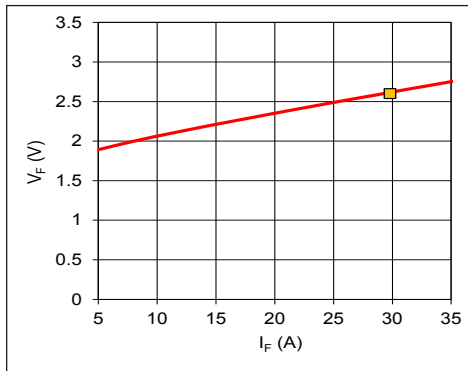

See notes 1,2, page 9.

**Optical Spectrum (Typical)**

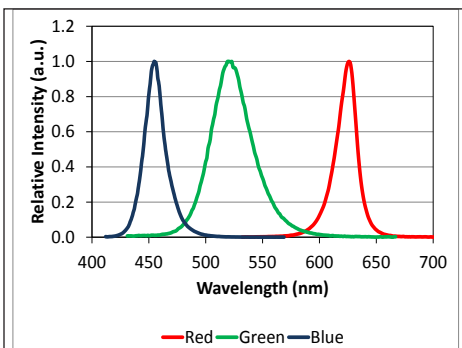

See note 5 on page 9.

Note 1: For Pulsed operation, the reference RGB duty cycles used are 25%, 50% and 25% respectively ( $T_{hs}=40^{\circ}C$ ).

Note 2: Yellow square indicate device operating point under reference conditions listed in the Optical and Electrical Characteristics table.

Note 3: Luminus maintains a tolerance of +/- 6% on flux measurements

Note 4: Parametric graphs for Red-Amber are TBD.

Note 5: Typical spectrum at recommended peak drive current .

### Thermal Resistance

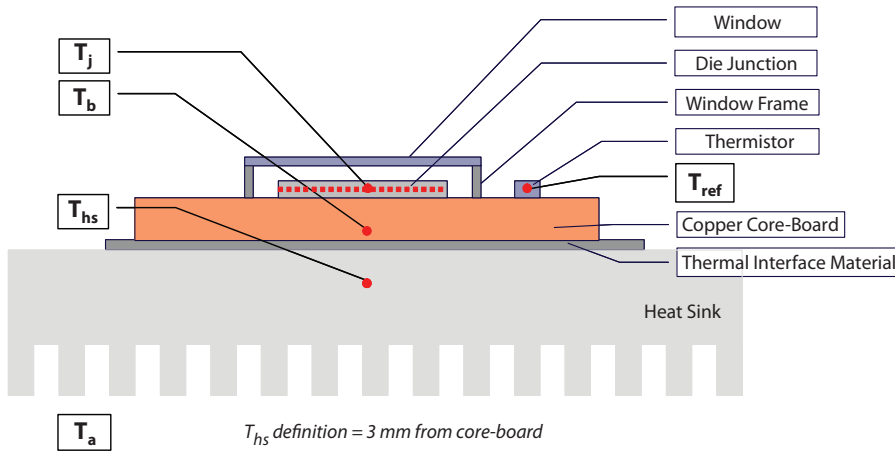

### Typical Thermal Resistance

$R_{\theta j-b}^1$	0.6°C/W
$R_{\theta b-hs}^2$	0.1 °C/W
$R_{\theta j-hs}^{1,2}$	0.7 °C/W
$R_{\theta j-ref}^2$	0.6 °C/W

Note 1: Thermal resistance values are based on FEA model results correlated to measured  $R_{\theta j-hs}$  data.

Note 2: Thermal Resistance is based on eGraf 1205 Thermal interface.

### Thermistor Information

The thermistor used in PT121 devices are mounted on coreboards is from Murata Manufacturing Co. The global part number is NCP15XH103J03RC. Please see <http://www.murata.com/> for details on calculating thermistor temperature.

For more information on use of the thermistor, please contact Luminus directly.

### Electrical Pinout

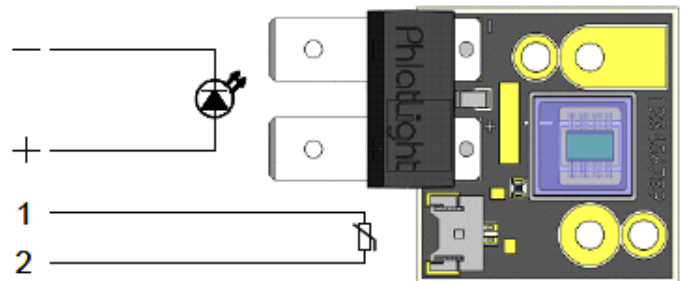

### Mechanical Dimensions

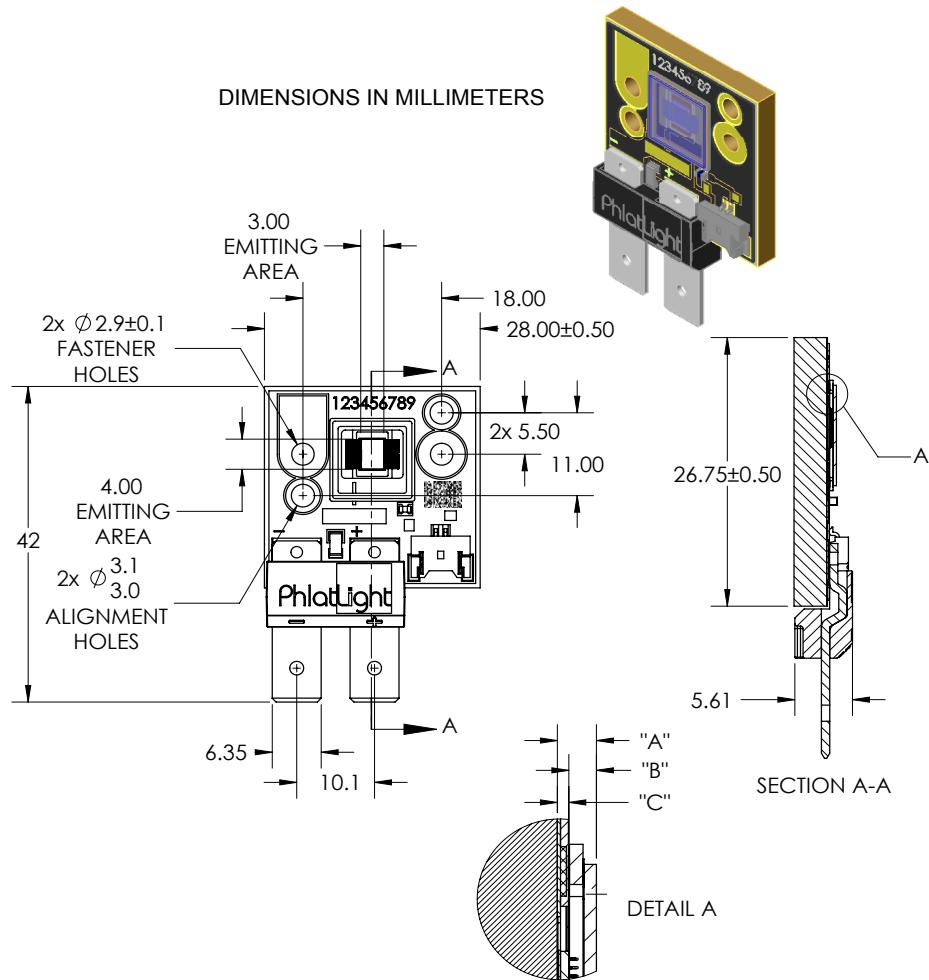

DIMENSION NAME	DESCRIPTION	NOMINAL DIMENSION	TOLERANCE
"A"	TOP OF METAL SUBSTRATE TO TOP OF GLASS	0.95	$\pm 0.13$
"B"	EMITTING AREA TO TOP OF GLASS	0.67	$\pm 0.16$
"C"	TOP OF METAL SUBSTRATE TO EMITTING AREA	0.28	$\pm 0.05$

Notes:

Recommended connector for Anode and Cathode: Panduit Disco Lok™ Series P/N: DNG14-250FL-C or equivalent  
 Thermistor Connector: MOLEX P/N 53780-0270. Recommended Female: MOLEX P/N 51146-0200 or equivalent  
 For detailed drawing of the PT121 Type CX package, please refer to the DWG-001268 mechanical specification document.

## Shipping Tray Outline

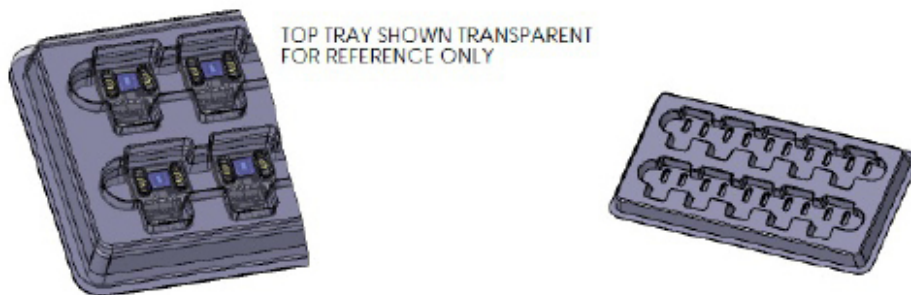
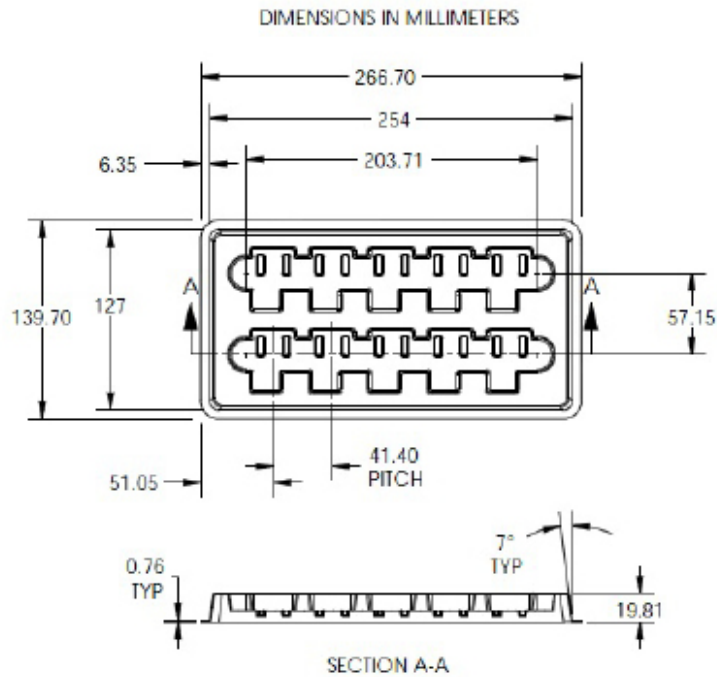

For detailed drawing of shipping trays, please refer to document TO-0479, available upon request.

## Packing and Shipping Specification (PT121)

### Packing Specification

Packing Configuration	Qty /Pack	Reel Dimensions (diameter x W, mm)	Gross Weight (kg)
Stack of 5 trays with 10 devices per tray Each pack is enclosed in ESD bag	50	150 x 280 x 85	2.7

### Product Label Specification



Sample label –for illustration only



#### Label Fields: (Label fields are subject to change)

- 6-8 digit Box number (for Luminus internal use)
- Luminus ordering part number
- Quantity of devices in pack
- Part number revision (for Luminus internal use)
- Customer's part number (optional)
- Flux Bin
- 2D Bar code

### Shipping Box

Shipping Box	Quantity	Material	Dimensions (L x W x H, mm)
Carton Box	1 -20 packs (50 - 1000 Devices)	S4651	560 x 560 x 200



## History of Changes

Rev		Description of Change
01	03/09	Initial Revision
02	09/09/09	Update Thermal Coefficients, Luminous Flux Max specifications, Vf Max specifications for Blue
03	03/01/10	Change Bin Kit EPA Blue specifications and ordering part numbers
04	11/01/10	Add Bin Kit MPC Green specification (preliminary) and ordering part numbers
05	01/11/11	Add Bin Kit flux definitions. Also defines bin kits available in sampling quantities only.
06	04/12/11	Update luminous flux and optical power specifications per test calibration update
07	08/01/11	Define additional Bin Kits and ordering part numbers
08	02/02/12	Add Red-Amber ordering part number; release new datasheet template and corporate logo

The products, their specifications and other information appearing in this document are subject to change by Luminus Devices without notice. Luminus Devices assumes no liability for errors that may appear in this document, and no liability otherwise arising from the application or use of the product or information contained herein. None of the information provided herein should be considered to be a representation of the fitness or suitability of the product for any particular application or as any other form of warranty. Luminus Devices' product warranties are limited to only such warranties as accompany a purchase contract or purchase order for such products. Nothing herein is to be construed as constituting an additional warranty. No information contained in this publication may be considered as a waiver by Luminus Devices of any intellectual property rights that Luminus Devices may have in such information. Big Chip LEDs™ is a registered trademark of Luminus Devices, Inc., all rights reserved.

This product is protected by U.S. Patents 6,831,302; 7,074,631; 7,083,993; 7,084,434; 7,098,589; 7,105,861; 7,138,666; 7,166,870; 7,166,871; 7,170,100; 7,196,354; 7,211,831; 7,262,550; 7,274,043; 7,301,271; 7,341,880; 7,344,903; 7,345,416; 7,348,603; 7,388,233; 7,391,059 Patents Pending in the U.S. and other countries.