

# SP3031 Series 0.8pF 10kV Unidirectional Discrete TVS

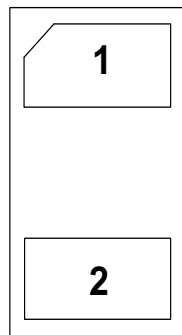

## Pinout



## Functional Block Diagram

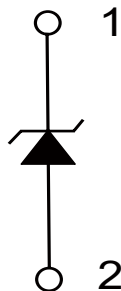

Life Support Note:  
**Not Intended for Use in Life Support or Life Saving Applications**  
The products shown herein are not designed for use in life sustaining or life saving applications unless otherwise expressly indicated.

## Description

The SP3031 includes low capacitance rail to rail diodes with an additional Zener diode to provide protection for electronic equipment that may experience destructive electrostatic discharges (ESD). These robust diodes can safely absorb repetitive ESD strikes above the maximum level specified in the IEC61000-4-2 international standard without performance degradation. The low loading capacitance makes it ideal for protecting high speed data lines.

## Features

- ESD protection of ±10kV contact discharge, ±15kV air discharge, (IEC61000-4-2)
- EFT, IEC61000-4-4, 40A (5/50ns)
- Lightning protection, IEC61000-4-5, 5A ( $t_p=8/20\mu s$ )
- Low capacitance of 0.8pF @  $V_R=0V$
- Low leakage current of 1µA at 5V
- 0402 small footprint available

## Applications

- USB 2.0, Ethernet
- MHL/MIPI/MDDI
- HDMI, Display Port, eSATA
- Set Top Boxes, Game Consoles
- Smart Phones
- External Storage
- Ultrabooks, Notebooks
- Tablets, eReaders

## USB2.0 Application Example

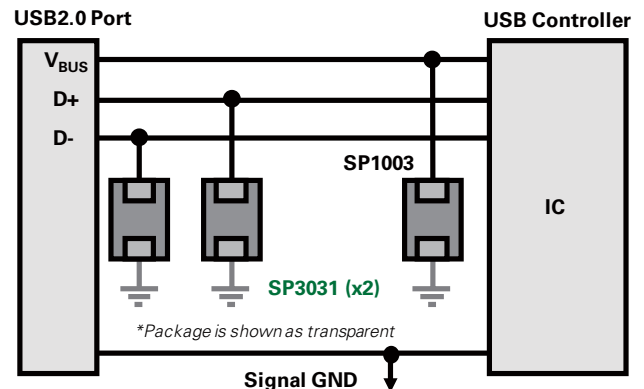

SP3031

### Absolute Maximum Ratings

Symbol	Parameter	Value	Units
$I_{PP}$	Peak Current ( $t_p=8/20\mu s$ )	5.0	A
$T_{OP}$	Operating Temperature	-40 to 85	°C
$T_{STOR}$	Storage Temperature	-50 to 150	°C

CAUTION: Stresses above those listed in "Absolute Maximum Ratings" may cause permanent damage to the device. This is a stress only rating and operation of the device at these or any other conditions above those indicated in the operational sections of this specification is not implied.

### Thermal Information

Parameter	Rating	Units
Storage Temperature Range	-65 to 150	°C
Maximum Junction Temperature	150	°C
Maximum Lead Temperature (Soldering 20-40s)	260	°C

### Electrical Characteristics ( $T_{OP}=25^\circ C$ )

Parameter	Symbol	Test Conditions	Min	Typ	Max	Units
Reverse Standoff Voltage	$V_{RWM}$				5.0	V
Reverse Breakdown Voltage	$V_{BR}$	$I_R=1mA$	6.0			V
Reverse Leakage Current	$I_{LEAK}$	$V_R=5V$ with 1pin at GND			1	$\mu A$
Clamp Voltage <sup>1</sup>	$V_C$	$I_{PP}=1A, t_p=8/20\mu s, Fwd$		6.9		V
		$I_{PP}=2A, t_p=8/20\mu s, Fwd$		7.5		V
Dynamic Resistance	$R_{DYN}$	$(V_{C2}-V_{C1})/(I_{PP2}-I_{PP1})$		0.6		$\Omega$
ESD Withstand Voltage <sup>1</sup>	$V_{ESD}$	IEC61000-4-2 (Contact)	$\pm 10$			kV
		IEC61000-4-2 (Air)	$\pm 15$			kV
Diode Capacitance <sup>1</sup>	$C_{I/O-I/O}$	Reverse Bias=0V		0.8		pF

Note: 1. Parameter is guaranteed by design and/or device characterization.

### Insertion Loss (S21) I/O to GND

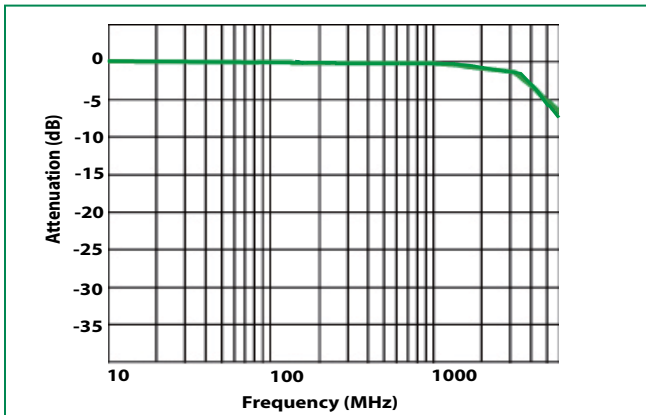

### Capacitance vs. Reverse Voltage

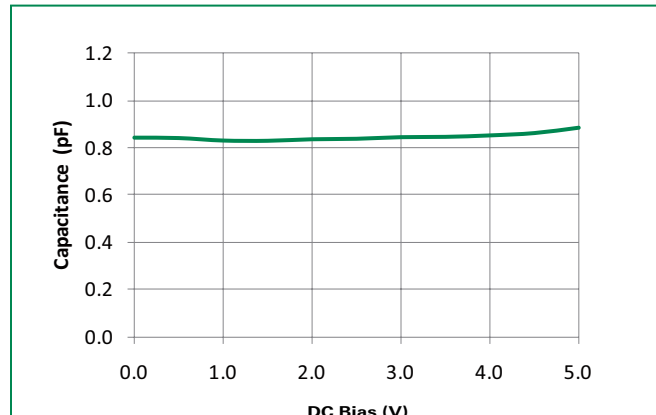

### Pulse Waveform

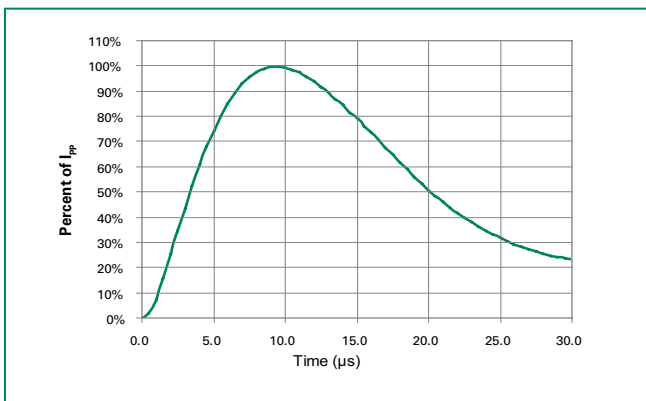

### Transmission Line Pulsing (TLP) Plot

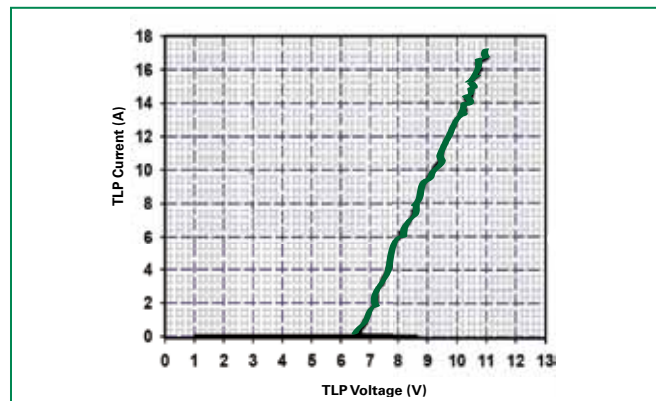

**Product Characteristics**

<b>Lead Plating</b>	Pre-Plated Frame or Matte Tin
<b>Lead Material</b>	Copper Alloy
<b>Lead Coplanarity</b>	0.0004 inches (0.102mm)
<b>Substitute Material</b>	Silicon
<b>Body Material</b>	Molded Epoxy
<b>Flammability</b>	UL 94 V-0

- Notes :
1. All dimensions are in millimeters
  2. Dimensions include solder plating.
  3. Dimensions are exclusive of mold flash & metal burr.
  4. Blo is facing up for mold and facing down for trim/form, i.e. reverse trim/form.
  5. Package surface matte finish VDI 11-13.

**Ordering Information**

Part Number	Package	Marking	Min. Order Qty.
SP3031-01ETG	SOD882	•f	12000

**Soldering Parameters**

<b>Reflow Condition</b>	Pb – Free assembly	
<b>Pre Heat</b>	- Temperature Min ( $T_{s(min)}$ )	150°C
	- Temperature Max ( $T_{s(max)}$ )	200°C
	- Time (min to max) ( $t_s$ )	60 – 180 secs
<b>Average ramp up rate (Liquidus) Temp (<math>T_L</math>) to peak</b>	3°C/second max	
<b><math>T_{s(max)}</math> to <math>T_L</math> - Ramp-up Rate</b>	3°C/second max	
<b>Reflow</b>	- Temperature ( $T_L$ ) (Liquidus)	217°C
	- Temperature ( $t_L$ )	60 – 150 seconds
<b>Peak Temperature (<math>T_p</math>)</b>	260 <sup>+0/-5</sup> °C	
<b>Time within 5°C of actual peak Temperature (<math>t_p</math>)</b>	20 – 40 seconds	
<b>Ramp-down Rate</b>	6°C/second max	
<b>Time 25°C to peak Temperature (<math>T_p</math>)</b>	8 minutes Max.	
<b>Do not exceed</b>	260°C	

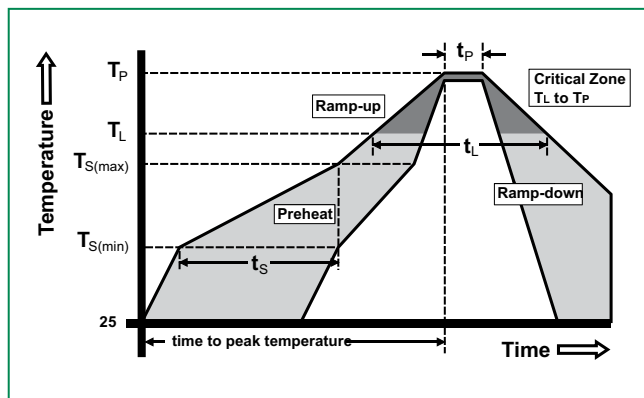

**Part Numbering System**

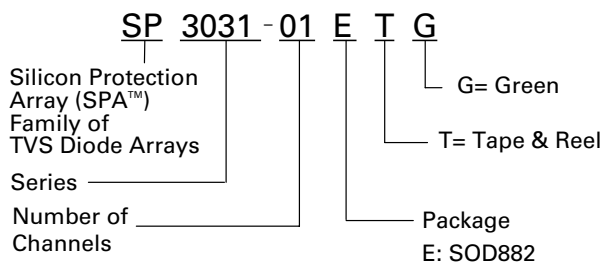

**Part Marking System**

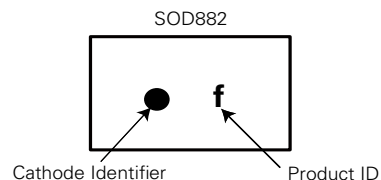

**Package Dimensions – SOD882**

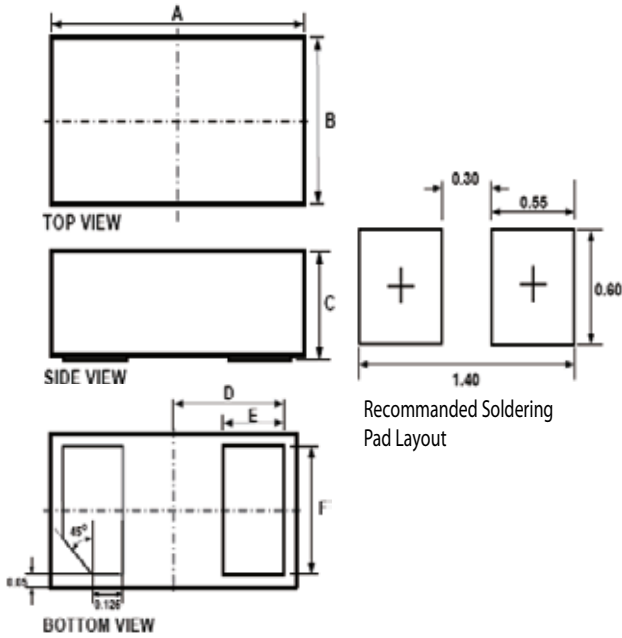

Symbol	Package	SOD882				
	JEDEC	MO-236				
	Millimeters			Inches		
	Min	Typ	Max	Min	Typ	Max
<b>A</b>	0.95	1.00	1.05	0.037	0.039	0.041
<b>B</b>	0.55	0.60	0.65	0.022	0.024	0.026
<b>C</b>	0.50	0.55	0.60	0.020	0.022	0.024
<b>D</b>	0.45			0.018		
<b>E</b>	0.20	0.25	0.30	0.008	0.010	0.012
<b>F</b>	0.45	0.50	0.55	0.018	0.020	0.022

**Embossed Carrier Tape & Reel Specification – SOD882**

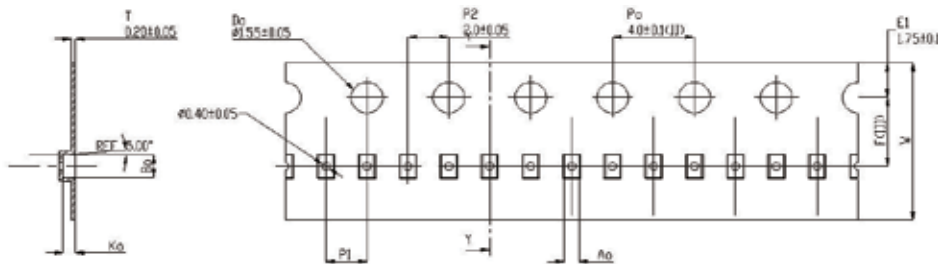

Symbol	Millimeters
<b>A0</b>	0.70+/-0.045
<b>B0</b>	1.10+/-0.045
<b>K0</b>	0.65+/-0.045
<b>F</b>	3.50+/-0.05
<b>P1</b>	2.00+/-0.10
<b>W</b>	8.00 + 0.30 -0.10

