

## LED Driver IC with Average-Mode Constant Current Control

### Features

- ▶ Fast average current control
- ▶ Correction for propagation delay and offset voltage
- ▶ Fixed off-time switching mode
- ▶ Linear dimming input
- ▶ PWM dimming input
- ▶ Output short circuit protection with programmable skip mode
- ▶ Input under-voltage shutdown

### Applications

- ▶ Backlighting of LCD Panels

### General Description

The HV9803 is an open loop average-mode current control LED driver IC operating in a constant off-time mode. The IC features  $\pm 2\%$  current accuracy, tight line and load regulation of the LED current without any need for loop compensation or high-side current sensing. Its auto-zero circuit cancels the effect of both the input offset voltage and the propagation delay in the current sense comparator.

The HV9803 can be powered from a 7.0~13.2V supply. The IC features fast PWM dimming response. The linear dimming input LD can accept a reference voltage up to 2.5V.

The IC is equipped with a current limit comparator for hiccup-mode output short circuit protection. It also features a programmable input under-voltage shutdown.

### Typical Application Circuit

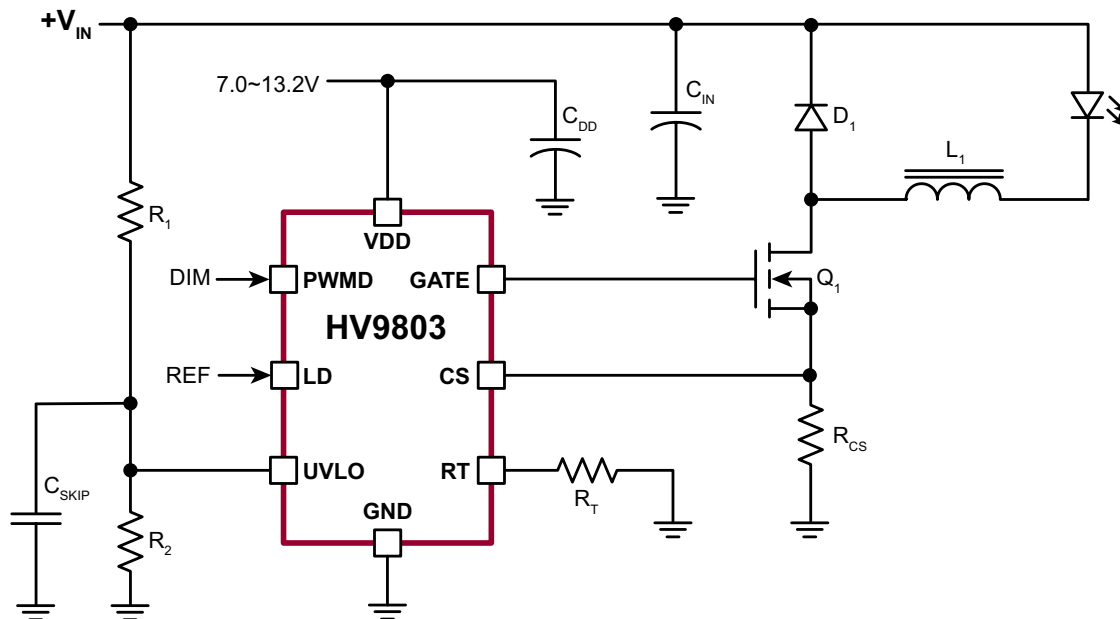

## Ordering Information

Part Number	Package Option	Packing
HV9803LG-G	8-Lead SOIC	2500/Reel

-G denotes a lead (Pb)-free / RoHS compliant package

## Pin Configuration

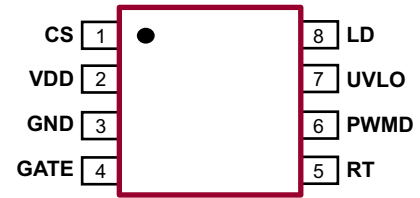

8-Lead SOIC

## Product Marking

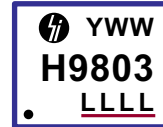

Y = Year Sealed  
 WW = Week Sealed  
 L = Lot Number  
 LLLL = "Green" Packaging

Package may or may not include the following marks: Si or

8-Lead SOIC

## Typical Thermal Resistance

Package	$\theta_{ja}$
8-Lead SOIC	101°C/W

## Absolute Maximum Ratings\*

Parameter	Value
VDD, GATE, CS	-0.3V to +14V
LD, RT, PWMD, UVLO	-0.3V to +6.0V
Junction temperature range	-40°C to +150°C
Storage temperature range	-65°C to +150°C
Power dissipation @ 25°C	650mW

Stresses beyond those listed under "Absolute Maximum Ratings" may cause permanent damage to the device. These are stress ratings only, and functional operation of the device at these or any other conditions beyond those indicated in the operational sections of the specifications is not implied. Exposure to absolute maximum rating conditions for extended periods may affect device reliability.

## Electrical Characteristics

(The \* denotes specifications which apply over the full operating ambient temperature range of  $-40^{\circ}\text{C} < T_A < 125^{\circ}\text{C}$ . Otherwise specifications are at  $T_A = 25^{\circ}\text{C}$ .  $V_{DD} = 12\text{V}$ ,  $PWMD = 5.0\text{V}$ , unless otherwise noted)

Sym	Description	Min	Typ	Max	Units	Conditions
-----	-------------	-----	-----	-----	-------	------------

### Input

$V_{DD}$	Input DC supply voltage range	*	-	-	13.2	V	DC input voltage
$I_{DD}$	Quiescent VDD supply current	*	-	1.5	2.5	mA	$V_{CS} = 0\text{V}$

### VDD Under-Voltage Lockout

$V_{DD(UV)}$	$V_{DD}$ under-voltage lockout threshold	*	6.45	6.70	6.95	V	$V_{DD}$ rising
$\Delta V_{DD(UV)}$	$V_{DD}$ under-voltage lockout hysteresis	-	-	500	-	mV	$V_{DD}$ falling

### PWM Dimming

$V_{EN(LO)}$	PWMD input low voltage	*	-	-	1.0	V	---
$V_{EN(HI)}$	PWMD input high voltage	*	2.6	-	-	V	---
$R_{EN}$	Internal pull-down resistance at PWMD	-	50	100	150	k $\Omega$	---

**Electrical Characteristics (cont.)**

(The \* denotes specifications which apply over the full operating ambient temperature range of  $-40^{\circ}\text{C} < T_A < 125^{\circ}\text{C}$ . Otherwise specifications are at  $T_A = 25^{\circ}\text{C}$ .  $V_{DD} = 12\text{V}$ ,  $\text{PWMD} = 5.0\text{V}$ , unless otherwise noted)

Sym	Description	Min	Typ	Max	Units	Conditions
-----	-------------	-----	-----	-----	-------	------------

**Current Sense Comparator**

$V_{LD}$	External reference voltage	-	0	-	3.0	V	---
$V_{CS}$	CS reference voltage	*	762	778	794	mV	$V_{LD} = 1.6\text{V}$
		*	955	975	995		$V_{LD} = 2.0\text{V}$
$A_{V(LD)}$	LD to CS voltage ratio	-	-	0.49	-	-	---
$T_{BLANK}$	Current sense blanking interval	*	150	-	280	ns	---
$T_{ON(MIN)}$	Minimum on-time	-	-	-	760	ns	$V_{CS} = 0.5V_{LD} + 30\text{mV}$
$D_{MAX}$	Maximum steady-state duty cycle	*	80	-	-	%	Reduction in output LED current may occur beyond this duty cycle

**Short Circuit Protection**

$V_{LIM}$	Internal current reference	-	1.57	-	1.93	V	---
$T_{DELAY}$	Current limit delay CS-to-GATE	-	-	-	150	ns	$V_{CS} = V_{LIM} + 30\text{mV}$
$R_{UVLO(R)}$	UVLO skip timer reset switch resistance	-	-	-	500	$\Omega$	---
$V_{UVLO(R)}$	UVLO skip timer reset voltage	-	200	-	300	mV	---
$T_{ON(MIN)}$	Minimum on-time (short circuit)	-	-	-	430	ns	$V_{CS} = V_{LIM} + 30\text{mV}$

 **$T_{OFF}$  Timer**

$T_{OFF}$	Off time	-	6.7	9.0	11.3	$\mu\text{s}$	$R_T = 250\text{k}\Omega$
			0.8	1.0	1.2	$\mu\text{s}$	$R_T = 25\text{k}\Omega$
$I_{RT(LIM)}$	RT over-current threshold	-	-	2.8	-	mA	---

**GATE Driver**

$I_{SOURCE}$	Gate sourcing current	-	0.165	-	-	A	$V_{GATE} = 0\text{V}$
$I_{SINK}$	Gate sinking current	-	0.165	-	-	A	$V_{GATE} = V_{DD}$
$t_{RISE}$	GATE output rise time	-	-	30	50	ns	$C_{GATE} = 500\text{pF}$
$t_{FALL}$	GATE output fall time	-	-	30	50	ns	$C_{GATE} = 500\text{pF}$

**UVLO**

UVLO	Under-voltage threshold voltage	*	1.17	-	1.29	V	$V_{UVLO}$ rising
$\Delta\text{UVLO}$	Under-voltage threshold voltage hysteresis	-	-	150	-	mV	$V_{UVLO}$ falling

# Guaranteed by design

\* Limits over temperature are guaranteed by design and characterization



## OFF Timer

In the HV9803, the timing resistor connected to RT determines the off-time of the gate driver, and it must be wired to GND. The equation governing the off-time of the GATE output is given by:

$$T_{OFF} = R_T \cdot 40pF$$

The  $R_T$  input is protected from short circuit. Over-current condition at  $R_T$  inhibits the IC.

## Current Sense Comparator and Timer Circuits

The function of the HV9803's current sense comparator is similar to that of a peak current controller. However, the GATE pulse is not terminated immediately as the LD threshold is met. The GATE turn off in the  $n^{th}$  cycle is delayed by a time  $T_{2,n}$  determined by a timer circuit as follows:

$$T_{2,n} = \frac{1}{2} \cdot (T_{1,n} + T_{1,n-1})$$

where  $T_{1,n}$  and  $T_{1,n-1}$  are the times to the LD threshold in any two consequent switching cycles. This iterative control law is needed for damping sub-harmonic oscillation.

Note, that the above control law is only valid up to a maximum switching duty cycle  $D_{max} = 0.8$ . Exceeding  $D_{max}$  will cause reduction in the LED current.

Propagation delay in the current sense comparator is one of the most significant contributors to the LED current error. It must be noted that the control scheme described above does not improve this deficiency of the peak-current control scheme by itself. Moreover, it samples the propagation delay during  $T_1$  and replicates it during  $T_2$ , essentially doubling the error introduced by this delay. In order to eliminate this error, the reference voltage is corrected by an auto-zero circuit. In essence, the HV9803 samples its CS signal when the current sense comparator triggers, detects the difference between the sampled CS level and the reference input of the current sense comparator. The resulting difference is subtracted from the reference level to generate a new reference in the next switching cycle.

## GATE Output

The GATE output of the HV9803 is used to drive an external MOSFET. It is recommended that the gate charge  $Q_G$  of the external MOSFET be less than 25nC for switching frequencies  $\leq 100kHz$  and less than 15nC for switching frequencies  $> 100kHz$ .

The resulting LED current is calculated from the equation:

$$I_{LED} = \frac{0.49 \cdot V_{LD} - 6mV}{R_{CS}}$$

## Short Circuit Protection

The HV9803 is equipped with a protection comparator having a CS threshold  $V_{LIM}$ . When this second threshold is triggered, the GATE output shuts off for the duration of a restart delay, determined by the RC constant at UVLO. The capacitor  $C_{SKIP}$  is discharged below 200mV. A restart delay due to charging  $C_{SKIP}$  to the UVLO start threshold is calculated as:

$$T_{SKIP} = k \cdot R_1 \cdot C_{SKIP} \cdot \ln \left( \frac{k \cdot V_{IN} - 0.30V}{k \cdot V_{IN} - 1.17V} \right)$$

where  $k = R_2 / (R_1 + R_2)$ .

## Under-Voltage Shutdown

Under-voltage comparator input is provided to disable the IC, when the UVLO input is below a threshold. Hysteresis is provided to avoid oscillation.

## Failure Modes and Effects Analysis (FMEA)

The HV9803 is designed to withstand short circuit between its adjacent pins without damage. The following table describes the effect of such incidental short circuit conditions.

Short Circuit Mode	Effect
CS to VDD	The IC triggers the short circuit protection and operates in the auto-restart mode continuously.
VDD to GND	Short circuit across the 12V should cause the external bias supply over-current protection.
GND to GATE	Should cause the external bias supply over-current protection. The power MOSFET Q1 is off.
RT to PWM	<p><u>Case 1 – PWMD = Lo:</u> The RT pin sources its maximum current. GATE = 0V, and Q1 is off.</p> <p><u>Case 2 – PWMD = Hi:</u> The RT pin is pulled up, shutting off the timer. GATE is off.</p>
PWMD to UVLO	This will overdrive the under-voltage threshold. However, since $V_{IN}$ UV condition is harmless to the IC, there is no effect.
UVLO to LD	LD overdrives the UVLO. If LD is lower than the UVLO threshold, the IC shuts off. No effect otherwise.

## Pin Description (8-Lead SOIC)

Pin	Name	Description
1	CS	This pin is the current sense pin used to detect the MOSFET source current by means of an external sense resistor.
2	VDD	This is the power supply input for the GATE output and input of the low-voltage regulator powering the internal logic. It must be bypassed with a low ESR capacitor to GND (at least 0.1 $\mu$ F).
3	GND	Ground return for all internal circuitry. This pin must be electrically connected to the ground of the power train.
4	GATE	This pin is the output gate driver for an external N-channel power MOSFET.
5	RT	A resistor connected between RT and GND programs the GATE off-time.
6	PWMD	This is the PWM dimming input of the IC. When this pin is pulled to GND, the gate driver is turned off. When the pin is pulled high, the gate driver operates normally.
7	UVLO	This pin is the under-voltage comparator input. It is also used to form a short-circuit protection skip delay.
8	LD	This pin is the reference voltage input for programming the LED current.

# 8-Lead SOIC (Narrow Body) Package Outline (LG)

4.90x3.90mm body, 1.75mm height (max), 1.27mm pitch

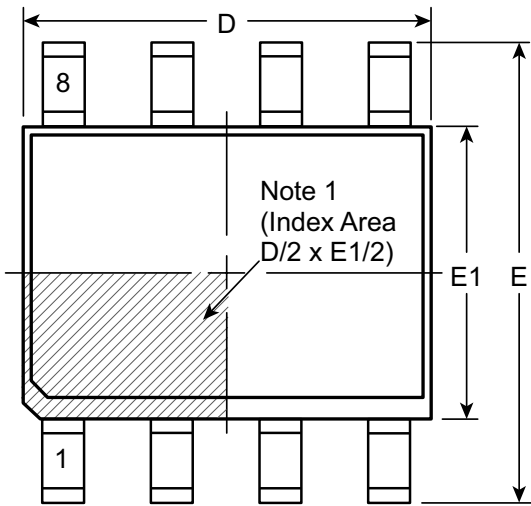

**Top View**

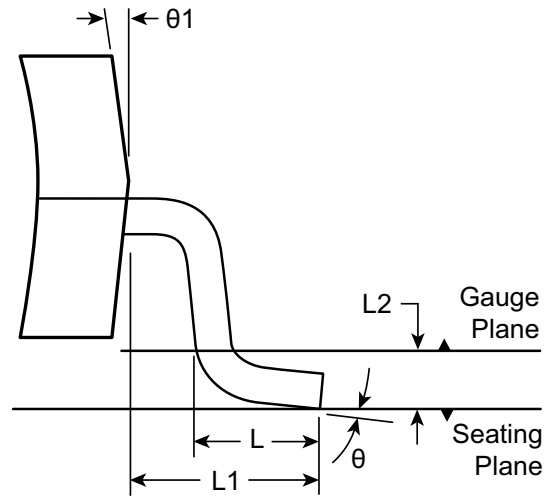

**View B**

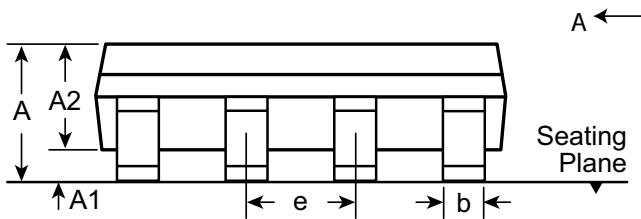

**Side View**

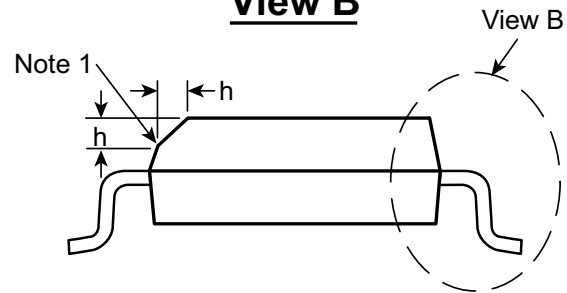

**View A-A**

**Note:**  
 1. This chamfer feature is optional. A Pin 1 identifier must be located in the index area indicated. The Pin 1 identifier can be: a molded mark/identifier; an embedded metal marker; or a printed indicator.

Symbol	A	A1	A2	b	D	E	E1	e	h	L	L1	L2	θ	θ1				
Dimension (mm)	MIN	1.35*	0.10	1.25	0.31	4.80*	5.80*	3.80*	1.27 BSC	0.25	0.40	1.04 REF	0.25	0°	5°			
	NOM	-	-	-	-	4.90	6.00	3.90		-	-		1.04			0.25	-	-
	MAX	1.75	0.25	1.65*	0.51	5.00*	6.20*	4.00*		0.50	1.27		1.04			0.25	8°	15°

JEDEC Registration MS-012, Variation AA, Issue E, Sept. 2005.

\* This dimension is not specified in the JEDEC drawing.

Drawings are not to scale.

Supertex Doc. #: DSPD-8SOLGTG, Version I041309.

(The package drawing(s) in this data sheet may not reflect the most current specifications. For the latest package outline information go to <http://www.supertex.com/packaging.html>.)

Supertex inc. does not recommend the use of its products in life support applications, and will not knowingly sell them for use in such applications unless it receives an adequate "product liability indemnification insurance agreement." Supertex inc. does not assume responsibility for use of devices described, and limits its liability to the replacement of the devices determined defective due to workmanship. No responsibility is assumed for possible omissions and inaccuracies. Circuitry and specifications are subject to change without notice. For the latest product specifications refer to the Supertex inc. (website: <http://www.supertex.com>)