

# CCS050M12CM2

## 1.2kV, 50A Silicon Carbide Six-Pack (Three Phase) Module

### Z-FET™ MOSFET and Z-Rec™ Diode

$V_{DS}$	1.2 kV
$R_{DS(on)}$ ( $T_J = 25^\circ C$ )	25 mΩ
$E_{OFF}$ ( $T_J = 150^\circ C$ )	0.6 mJ

#### Features

- Ultra Low Loss
- Zero Reverse Recovery Current
- Zero Turn-off Tail Current
- High-Frequency Operation
- Positive Temperature Coefficient on  $V_F$  and  $V_{DS(on)}$
- Cu Baseplate, AlN DBC

#### System Benefits

- Enables Compact and Lightweight Systems
- High Efficiency Operation
- Ease of Transistor Gate Control
- Reduced Cooling Requirements
- Reduced System Cost

#### Applications

- Solar Inverters
- UPS and SMPS
- Induction Heating
- Regen Drives
- 3-Phase PFC
- Motor Drives

#### Package



Part Number	Package	Marking
CCS050M12CM2	Six-Pack	CCS050M12CM2

#### Maximum Ratings ( $T_C = 25^\circ C$ unless otherwise specified)

Symbol	Parameter	Value	Unit	Test Conditions	Notes
$V_{DS}$	Drain - Source Voltage	1.2	kV		
$V_{GS}$	Gate - Source Voltage	+25/-10	V		
$I_D$	Continuous Drain Current	87	A	$V_{GS} = 20V, T_C = 25^\circ C$	Fig. 21
		61		$V_{GS} = 20V, T_C = 90^\circ C$	
$I_{D(pulse)}$	Pulsed Drain Current	250	A	Pulse width $t_p = 50 \mu s$ Rate limited by $T_{jmax}, T_C = 25^\circ C$	
$T_J$	Junction Temperature	150	$^\circ C$		
$T_C, T_{STG}$	Case and Storage Temperature Range	-40 to +150	$^\circ C$		
$V_{isol}$	Case Isolation Voltage	2.5	kV	DC, $t = 1min$	
$L_{Stray}$	Stray Inductance	30	nH	Measured from pins 25-26 to 27-28	
M	Mounting Torque	5.0	Nm		
G	Weight	180	g		
$P_D$	Power Dissipation	337	W	$T_C = 25^\circ C, T_J \leq 150^\circ C$	



## Electrical Characteristics ( $T_c = 25^\circ\text{C}$ unless otherwise specified)

Symbol	Parameter	Min.	Typ.	Max.	Unit	Test Conditions	Note
$V_{(BR)DSS}$	Drain - Source Breakdown Voltage	1.2			kV	$V_{GS} = 0V, I_D = 100 \mu A$	
$V_{GS(th)}$	Gate Threshold Voltage		2.3		V	$V_{DS} = 10 V, I_D = 2.5 \text{ mA}$	
			1.6			$V_{DS} = 10 V, I_D = 2.5 \text{ mA}, T_J = 150^\circ\text{C}$	
$I_{DSS}$	Zero Gate Voltage Drain Current		2	100	$\mu A$	$V_{DS} = 1.2 \text{ kV}, V_{GS} = 0V$	
$I_{GSS}$	Gate-Source Leakage Current			0.5	$\mu A$	$V_{GS} = 20 V, V_{DS} = 0V$	
$R_{DS(on)}$	On State Resistance		25	34	$m\Omega$	$V_{GS} = 20 V, I_D = 50 \text{ A}$	Fig. 4 5,6,7
			43	63		$V_{GS} = 20 V, I_D = 50 \text{ A}, T_J = 150^\circ\text{C}$	
$g_{fs}$	Transconductance		22		S	$V_{DS} = 20 V, I_D = 50 \text{ A}$	Fig. 8
			21			$V_{DS} = 20 V, I_D = 50 \text{ A}, T_J = 150^\circ\text{C}$	
$C_{iss}$	Input Capacitance		2.810		nF	$V_{DS} = 800V, V_{GS} = 0V$ $f = 1\text{MHz}, V_{AC} = 25\text{mV}$	Fig. 16,17
$C_{oss}$	Output Capacitance		0.393				
$C_{rss}$	Reverse Transfer Capacitance		0.014				
$E_{on}$	Turn-On Switching Energy		1.1		mJ	$V_{DD} = 600V, V_{GS} = +20V/-5V$ $I_D = 50A, R_G = 20\Omega$ Inductive Load = 200 $\mu H$ $T_J = 150^\circ\text{C}$ Note: IEC 60747-8-4 Definitions	Fig. 18
$E_{off}$	Turn-Off Switching Energy		0.6		mJ		
$R_G$	Internal Gate Resistance		1.5		$\Omega$	$f = 1\text{MHz}, V_{AC} = 25\text{mV}$	
$Q_G$	Gate Charge		180		nC	$V_{DD} = 800V, I_D = 50A$	Fig. 15
<b>Resistive Switching</b>							
$t_{d(on)}$	Turn-on delay time		21		ns	$V_{DD} = 800V, R_{LOAD} = 8 \Omega$ $V_{GS} = +20/-2V, R_G = 3.8 \Omega$ $T_J = 25^\circ\text{C}$ Note: IEC 60747-8-4 Definitions	
$t_{r(on)}$	$V_{SD}$ fall time 90% to 10%		30		ns		
$t_{d(off)}$	Turn-off delay time		50		ns		
$t_{r(off)}$	$V_{SD}$ rise time 10% to 90%		19		ns		

**Module Application Note:** The SiC MOSFET module switches at speeds beyond what is customarily associated with IGBT based modules. Therefore, special precautions are required to realize the best performance. The interconnection between the gate driver and module housing needs to be as short as possible. This will afford the best switching time and avoid the potential for device oscillation. Also, great care is required to insure minimum inductance between the module and link capacitors to avoid excessive  $V_{DS}$  overshoots.



### Free-Wheeling SiC Schottky Diode Characteristics

Symbol	Parameter	Min.	Typ.	Max.	Unit	Test Conditions	Note
V <sub>SD</sub>	Diode Forward Voltage		1.6	1.85	V	I <sub>F</sub> = 50A, V <sub>GS</sub> = 0	
			2.2			I <sub>F</sub> = 50A, T <sub>J</sub> = 150°C	
Q <sub>C</sub>	Total Capacitive Charge		0.28		μC	I <sub>F</sub> = 25A, V <sub>R</sub> = 1000V di <sub>F</sub> /dt = 500 A/μs, T <sub>J</sub> = 25°C	
C	Total Capacitance		3.42		nF	V <sub>R</sub> =0V, f = 1MHz, T <sub>J</sub> = 25°C	
			0.23			V <sub>R</sub> =400V, f = 1MHz, T <sub>J</sub> = 25°C	
			0.18			V <sub>R</sub> =800V, f = 1MHz, T <sub>J</sub> = 25°C	
I <sub>F</sub>	Continuous Forward Current		50		A	V <sub>GS</sub> = -5V, T <sub>case</sub> = 100°C	

### Thermal Characteristics

Symbol	Parameter	Min.	Typ.	Max.	Unit	Test Conditions	Note
R <sub>thJCM</sub>	Thermal Resistance Junction-to-Case for MOSFET		0.37	0.49	°C/W		
R <sub>thJCD</sub>	Thermal Resistance Junction-to-Case for Diode		0.42	0.48			

# Typical Performance

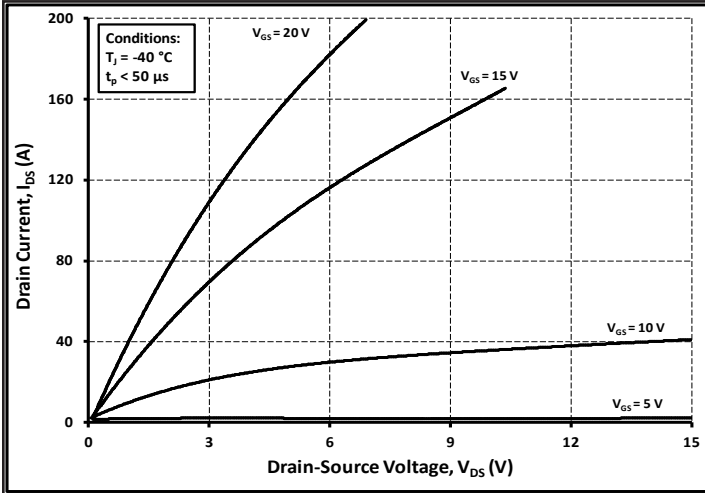

Figure 1. Typical Output Characteristics  $T_J = -40^\circ\text{C}$

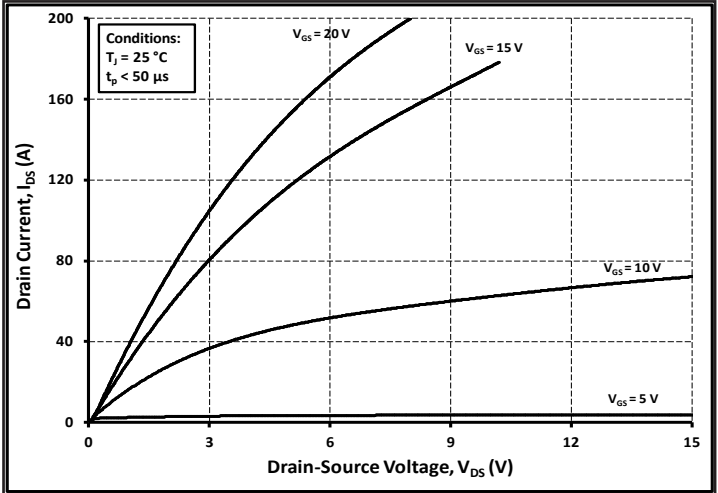

Figure 2. Typical Output Characteristics  $T_J = 25^\circ\text{C}$

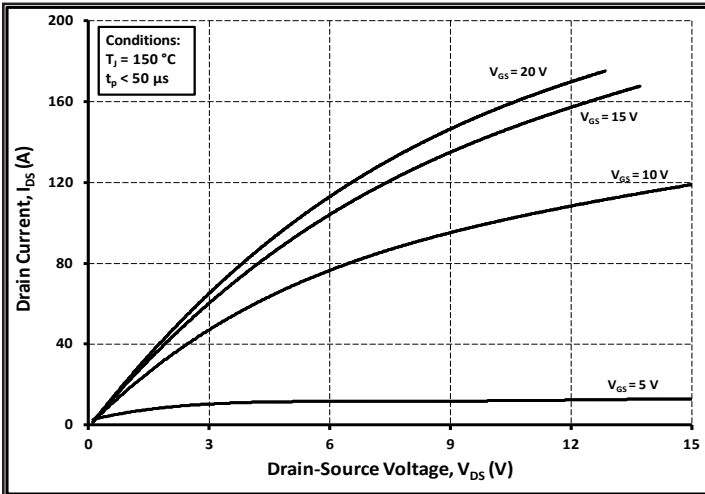

Figure 3. Typical Output Characteristics  $T_J = 150^\circ\text{C}$

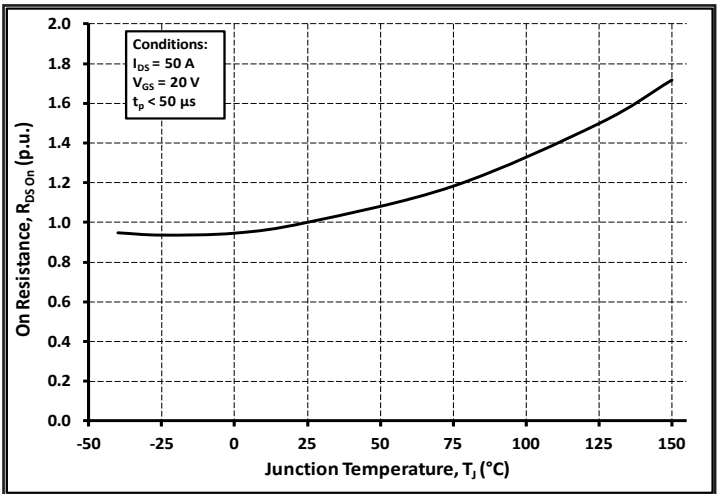

Figure 4. Normalized On-Resistance vs. Temperature

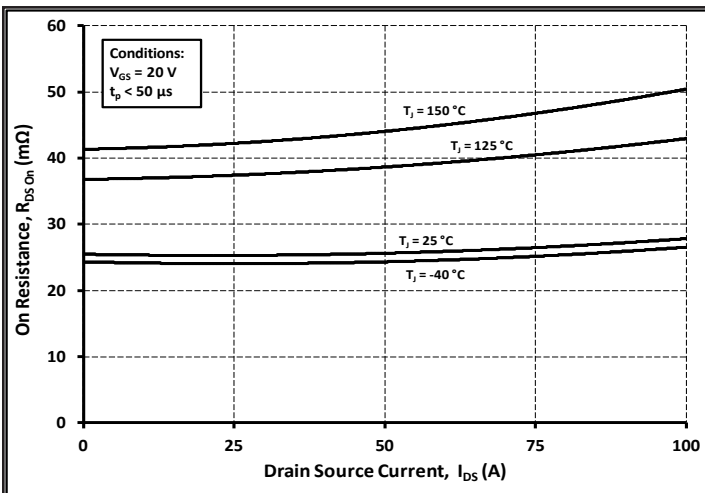

Figure 5. Normalized On-Resistance vs. Drain Current For Various Temperatures

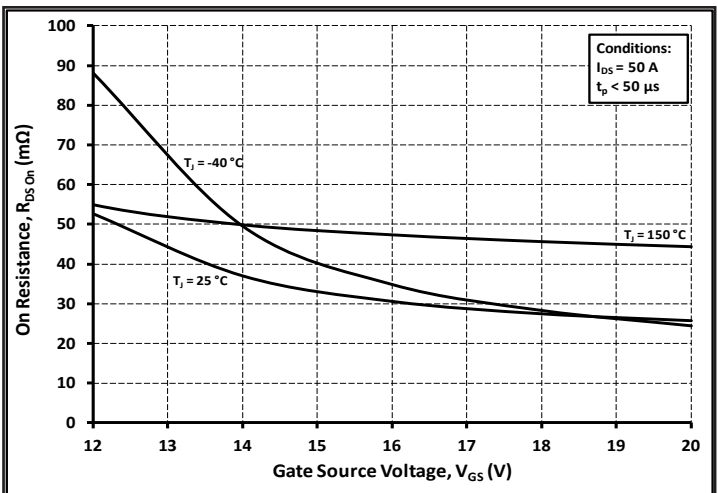

Figure 6. Normalized On-Resistance vs. Gate-Source Voltage for Various Temperatures

# Typical Performance

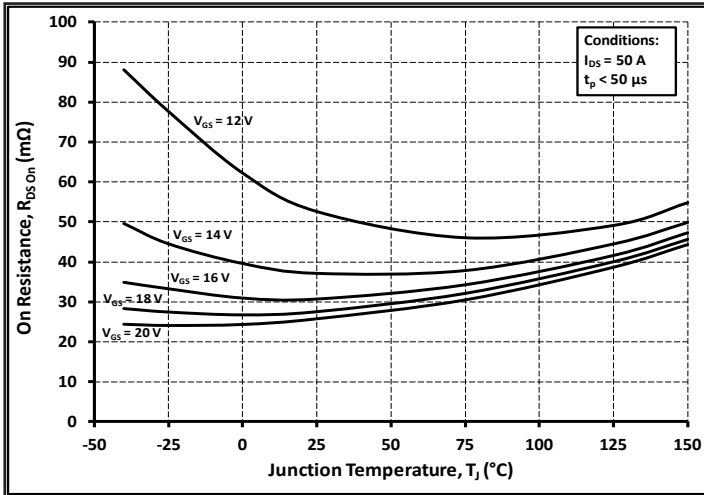

Figure 7. On-Resistance vs. Temperature for Various Gate-Source Voltages

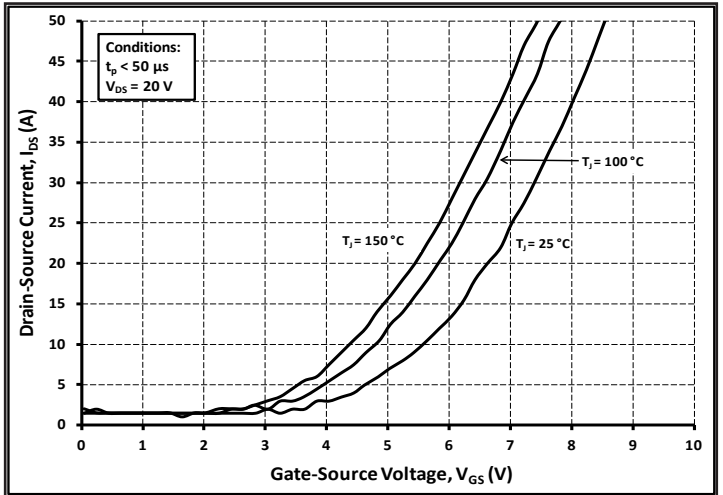

Figure 8. Transfer Characteristic for Various Junction Temperatures

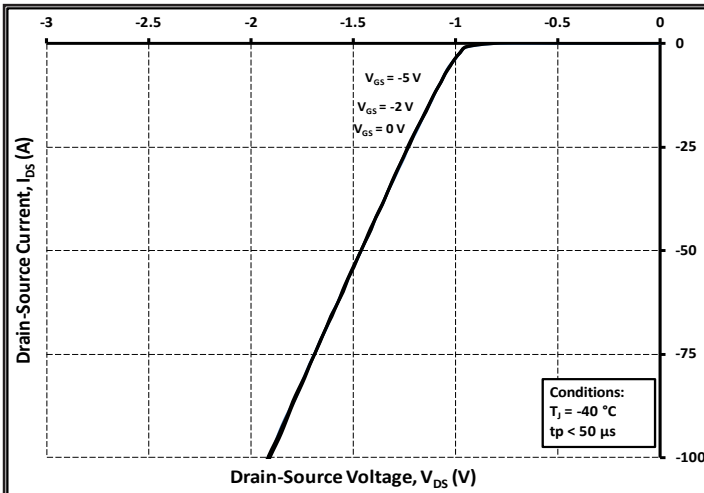

Figure 9. Diode Characteristic at -40°C

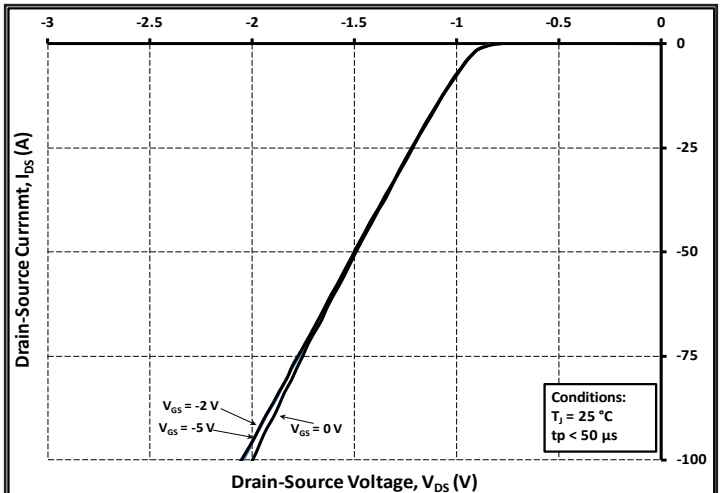

Figure 10. Diode Characteristic at 25°C

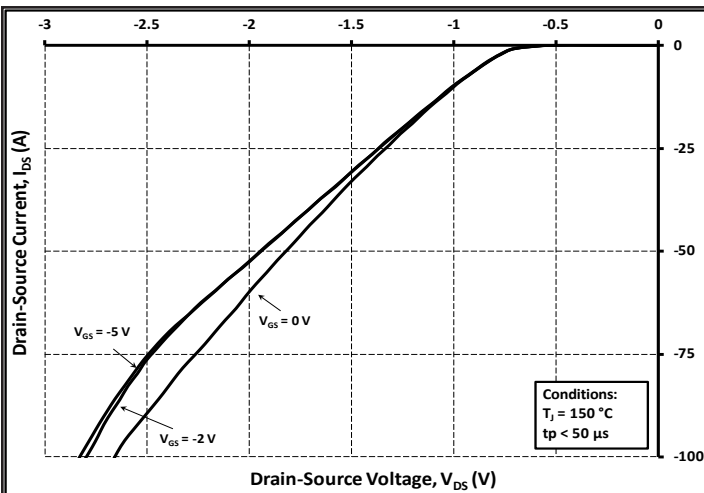

Figure 11. Diode Characteristic at 150°C

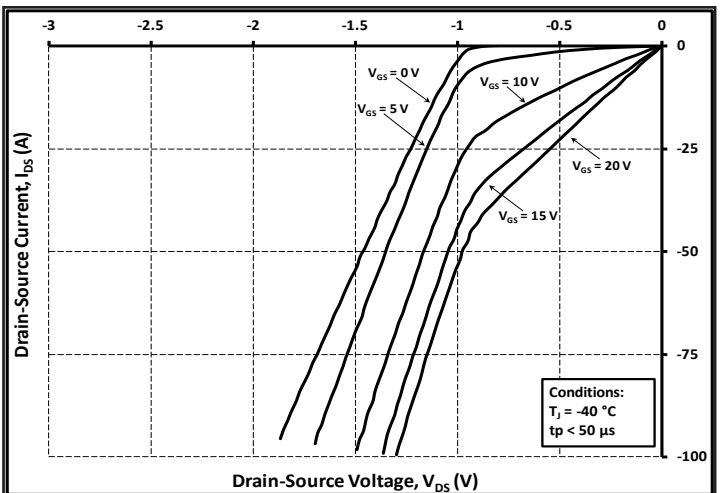

Figure 12. 3rd Quadrant Characteristic at -40°C

# Typical Performance

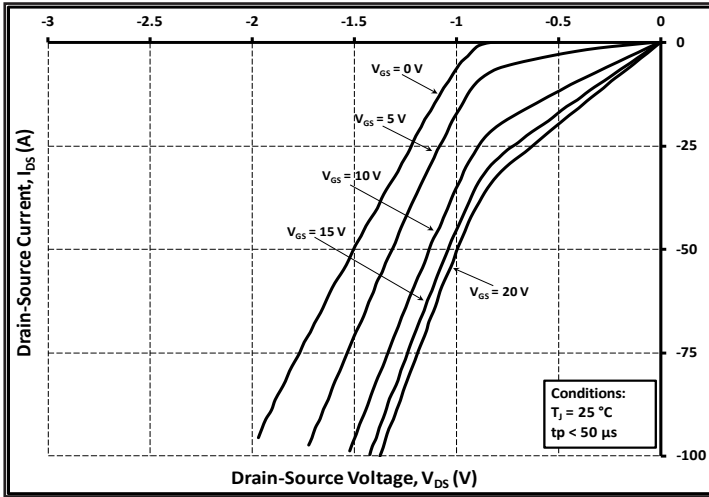

Figure 13. 3rd Quadrant Characteristic at 25°C

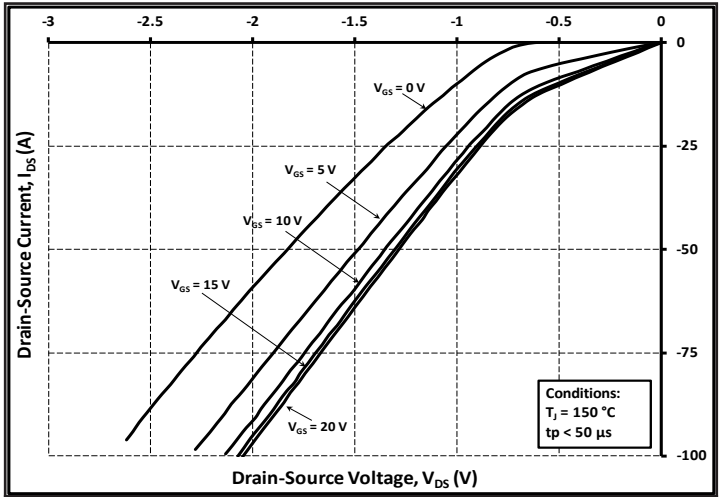

Figure 14. 3rd Quadrant Characteristic at 150°C

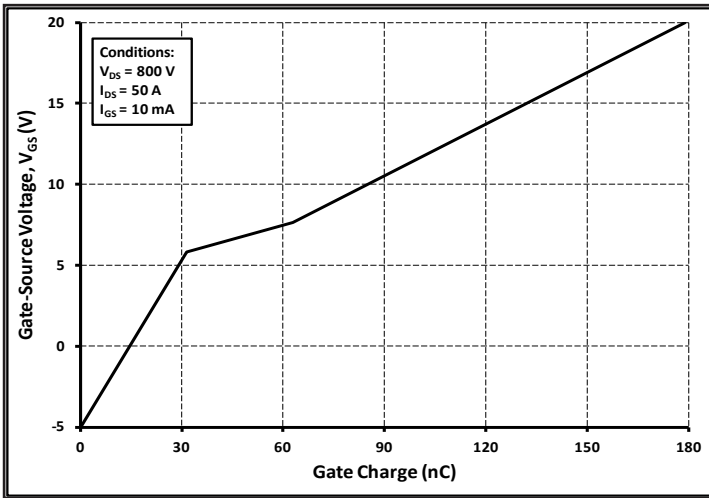

Figure 15. Typical Gate Charge Characteristics

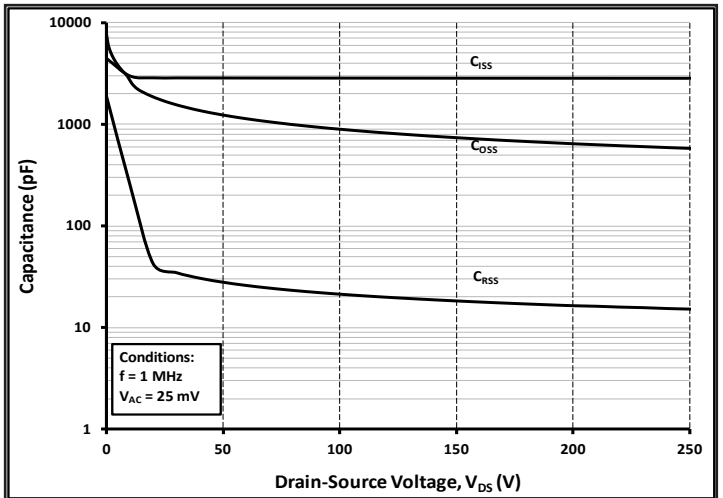

Figure 16. Typical Capacitances vs. Drain-Source Voltage (0 - 250V)

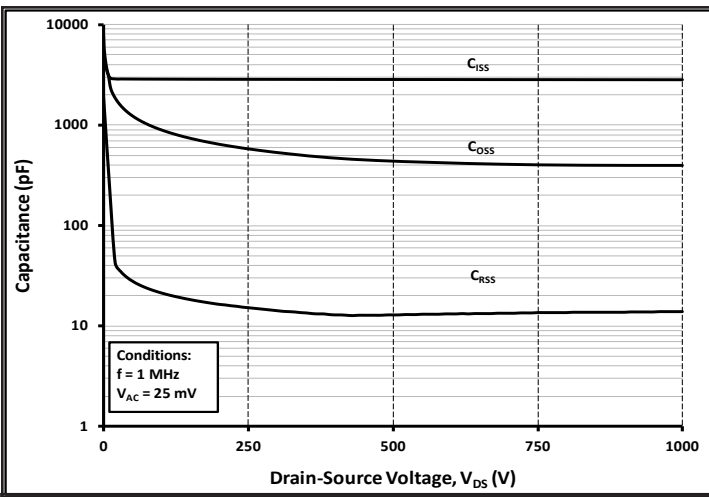

Figure 17. Typical Capacitances vs. Drain-Source Voltage (0 - 1000V)

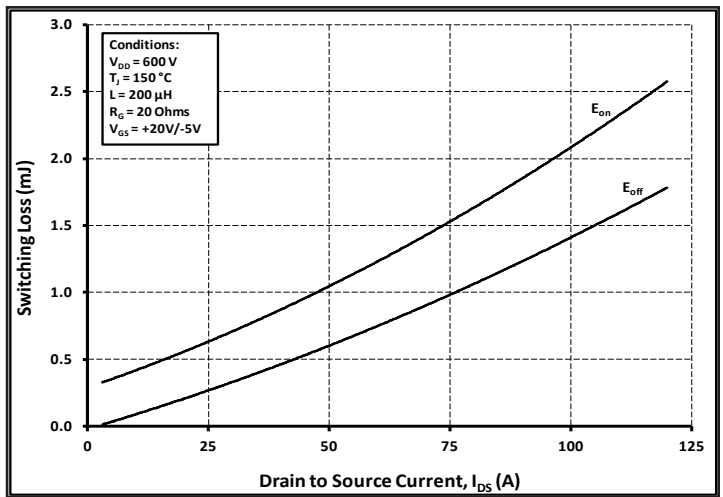

Figure 18. Inductive Switching Energy vs. Drain Current For  $V_{DS} = 600V$ ,  $R_G = 20 \Omega$

# Typical Performance

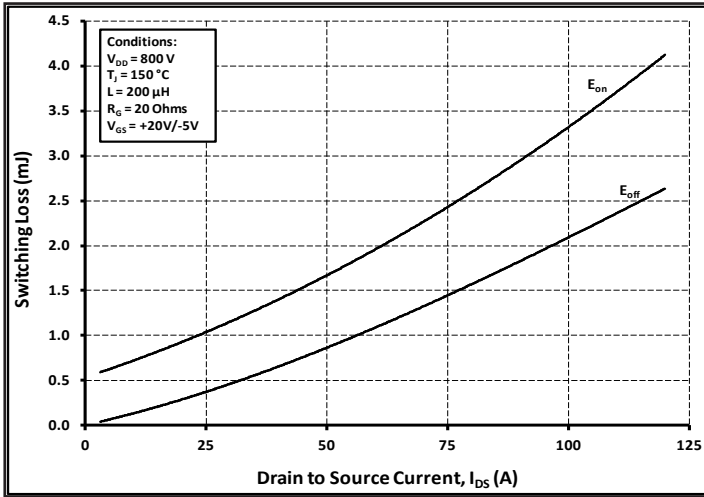

Figure 19. Inductive Switching Energy vs. Drain Current For  $V_{DS} = 800\text{V}$ ,  $R_G = 20\text{ }\Omega$

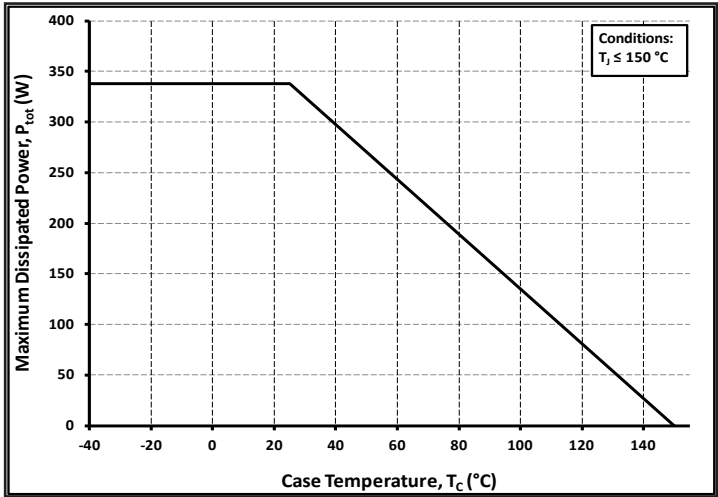

Figure 20. Power Dissipation Derating Curve

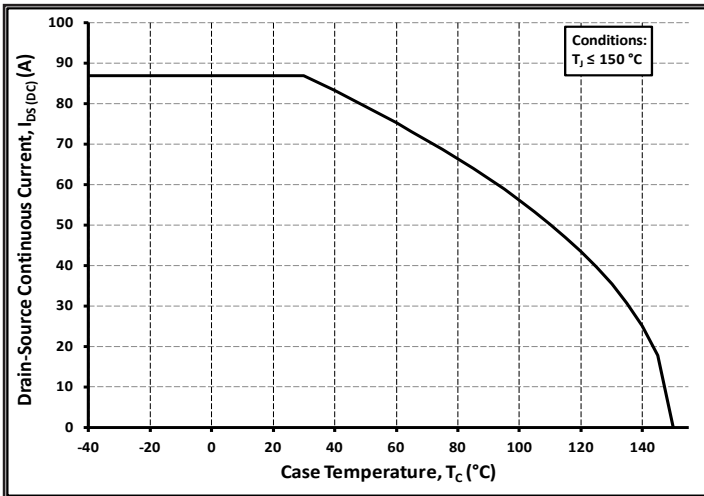
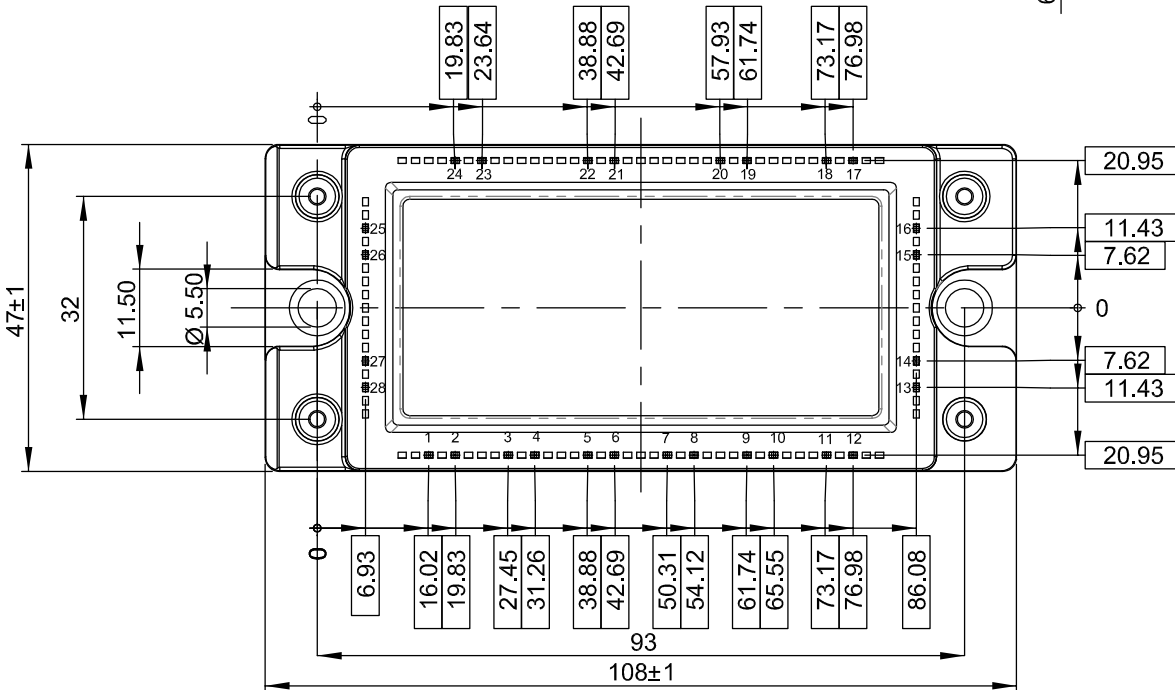
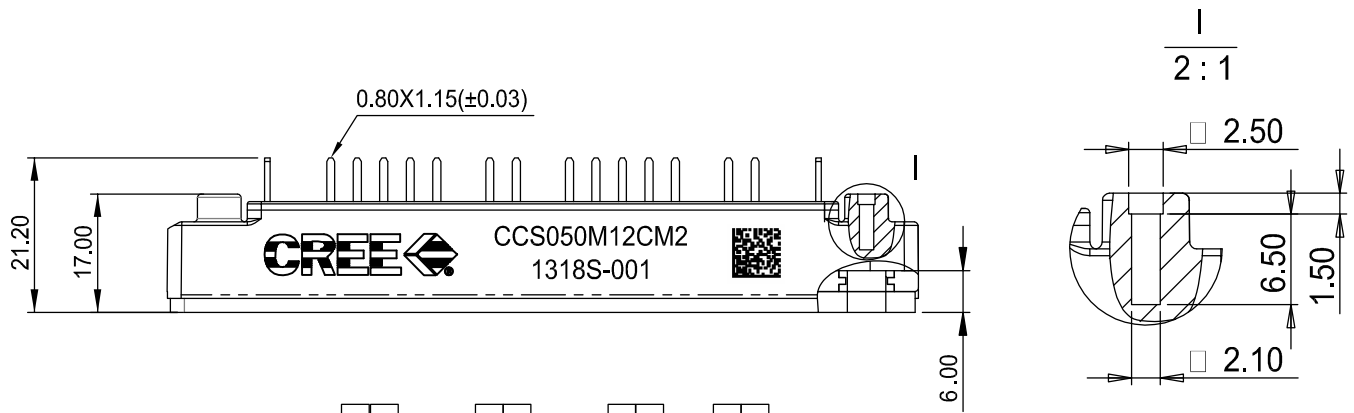
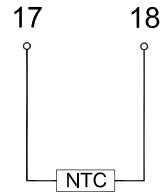
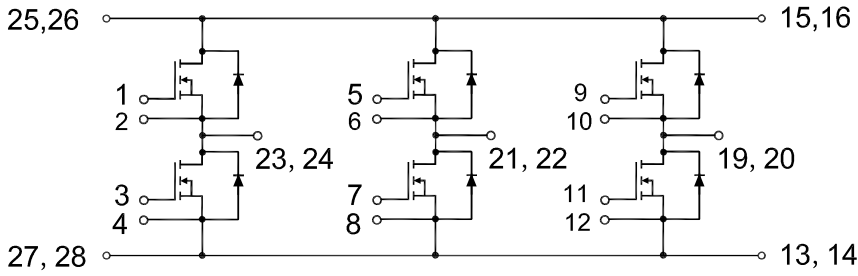

Figure 21. Continuous Current Derating Curve

## Package Dimensions (mm)



This product has not been designed or tested for use in, and is not intended for use in, applications implanted into the human body nor in applications in which failure of the product could lead to death, personal injury or property damage, including but not limited to equipment used in the operation of nuclear facilities, life-support machines, cardiac defibrillators or similar emergency medical equipment, aircraft navigation or communication or control systems, air traffic control systems, or weapons systems.

Copyright © 2013 Cree, Inc. All rights reserved. The information in this document is subject to change without notice. Cree and the Cree logo are registered trademarks and Z-Rec is a trademark of Cree, Inc.

Cree, Inc.  
4600 Silicon Drive  
Durham, NC 27703  
USA Tel: +1.919.313.5300  
Fax: +1.919.313.5451  
www.cree.com/power